



District of Columbia Water and Sewer Authority  
David L. Gadis, CEO and General Manager

---

# Northeast Boundary Tunnel Project Tunnel Forum

*4th Street NE and Rhode Island Avenue NE Construction Sites*

**Thursday, September 16, 2021**  
**Zoom Meeting**



[DCWATER.COM](http://DCWATER.COM)

## Welcome to the Tunnel Forum Virtual Meeting!



### Participation Tips:

- Online meetings are subject to your bandwidth limitations. If your connection to the meeting should freeze, please exit and reenter the meeting to refresh your connection.
- Participants may opt to turn on or off your video.
- All participant lines are muted to minimize disruptions.
- The Questions and Answers period will be held at the end of the presentation. **Please hold your questions until the Q&A portion of the meeting.**
- During the Question and Answer period of the meeting, we will acknowledge questions from participants who are online and on phone.
- **ONLINE PARTICIPANTS:** send your questions to the Host by using the Chat mode. You may also click on “Participants” to raise your hand for a question.
- **PHONE PARTICIPANTS:** press \*9 to alert us that you want to ask a question. We will unmute you when it’s your turn to ask a question.

# Agenda

---

- Video of the NEBT
  - Safety First
  - Project Overview
  - Responses to Community Concerns
  - Construction Site Updates
    - 4th Street NE
    - Rhode Island Avenue NE
- NEBT Claims Process
  - Rhode Island Avenue NE Main Street Partnership-Business
  - Questions and Answers
  - Contact Us



# We Want Everyone To Be Safe

Alan Etter

---

The city's response to Covid-19 is evolving. To see more on the city's response, go to [coronavirus.dc.gov](https://coronavirus.dc.gov). For coronavirus testing in DC, call **1-855-363-0333**.

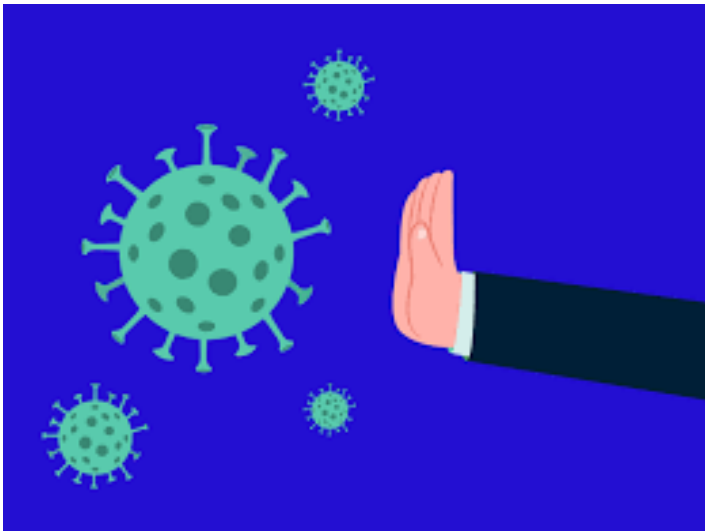

**The NEBT Team has taken the following actions to ensure the safety of employees:**

- Employees in the tunnel must undergo temperature screening at the start of their shift
- Masks and other personal protective equipment must be worn by all employees on site
- Employees maintain at least six feet of distance when possible whether on above or below ground operations
- All shared tools & equipment are regularly sanitized
- Please let us know how to make our engagement with you better

## **Outreach During Quarantine**

Our team continues to engage the community through virtual meetings, email, door-to-door newsletter distribution (when necessary) and can be reached by email at [dccleanrivers@dcwater.com](mailto:dccleanrivers@dcwater.com) and by calling the NEBT Hotline at **1-800-988-6151**.

# Northwest Boundary Tunnel Project: Benefits

## Bill Levy

- Over 11 billion gallons captured to date
- Over 6,911 tons of trash, debris, and other solids captured
- Exceeding predicted capture rate (90% > 80%)
- First year in operation was the wettest year on record for the District of Columbia

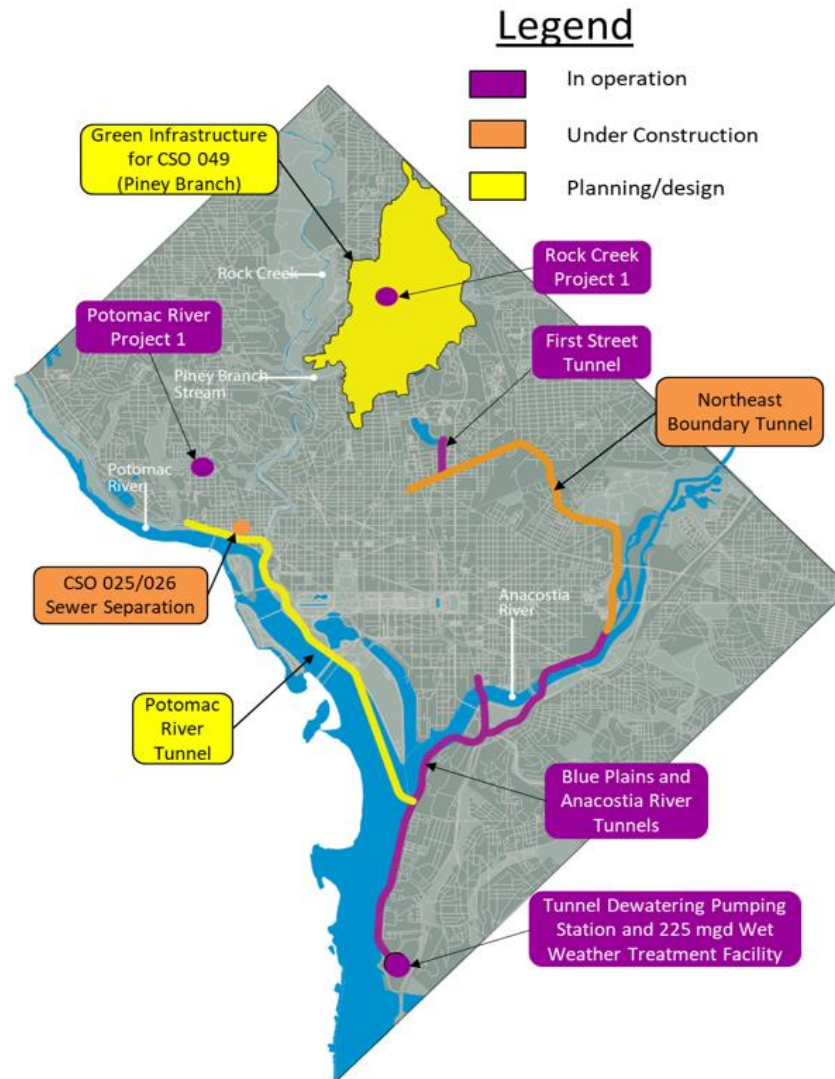

- Reduce the frequency and magnitude of street flooding
- Significantly mitigate the frequency, magnitude, and duration of sewer flooding and basement backups in the Northeast Boundary drainage area
- Reduce risks to human health
- Control \*combined sewer overflow (CSO) discharges to the Anacostia River, significantly improving water quality
- Prevent deterioration of historic resources from water damage caused by flooding

\* CSO = Combined Sewer Overflows.  
Learn more at [dcwater.com/css](http://dcwater.com/css).

# Responses to Community Concerns

## Hadiyah Jordan

CONCERN	RESPONSE
<p>The truck restriction signs for Douglas Street NE are missing.</p>	<p>The contractor replaced the No Trucks Allowed sign on Douglas Street NE at 4<sup>th</sup> Street NE.</p>
<p>At the 4th Street NE construction site 2 loud horns were sounding every time the crane moved something.</p>	<p>The contractor should signal with an audible alert to protect workers when there are overhead crane loads. While we need to ensure safety, DC Water reminded the contractor of the need to comply but do not over signal.</p>
<p>The Road Closed and Do Not Enter signs at Bryant Street and 3rd Street NE by the 4th Street site were recently removed. Can they be restored?</p>	<p>Barricades and signage have disappeared multiple times. New Do Not Enter signs were posted on 3rd Street NE.</p>
<p>What are the NEBT parking restrictions or changes? What about parking with Residential Parking Permits Only and Street Cleaning day?</p>	<p>NEBT construction manages parking restrictions in some areas near the construction sites and are identified with No Parking signage. Residential Parking Permits are managed by the Department of Motor Vehicles. Street Cleaning is managed by the Department of Public Works.</p>



# Construction Site Updates & Percent Complete

## Andrea Sesenna and Matt Wolniak

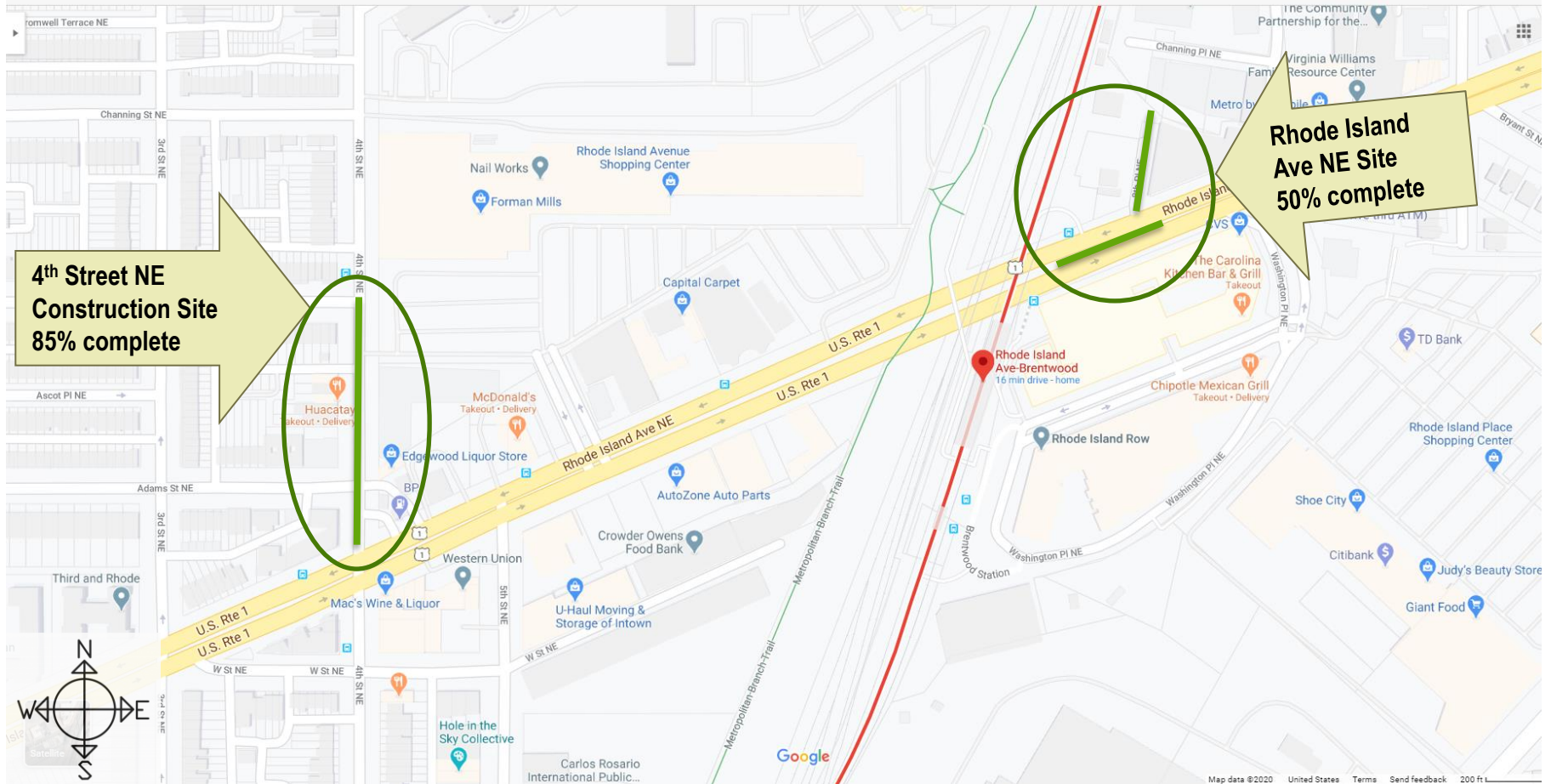

The green line = the Construction Site locations.



# 4<sup>th</sup> Street NE Construction Site

## Andrea Sesenna

All construction dates are approximate and could change.

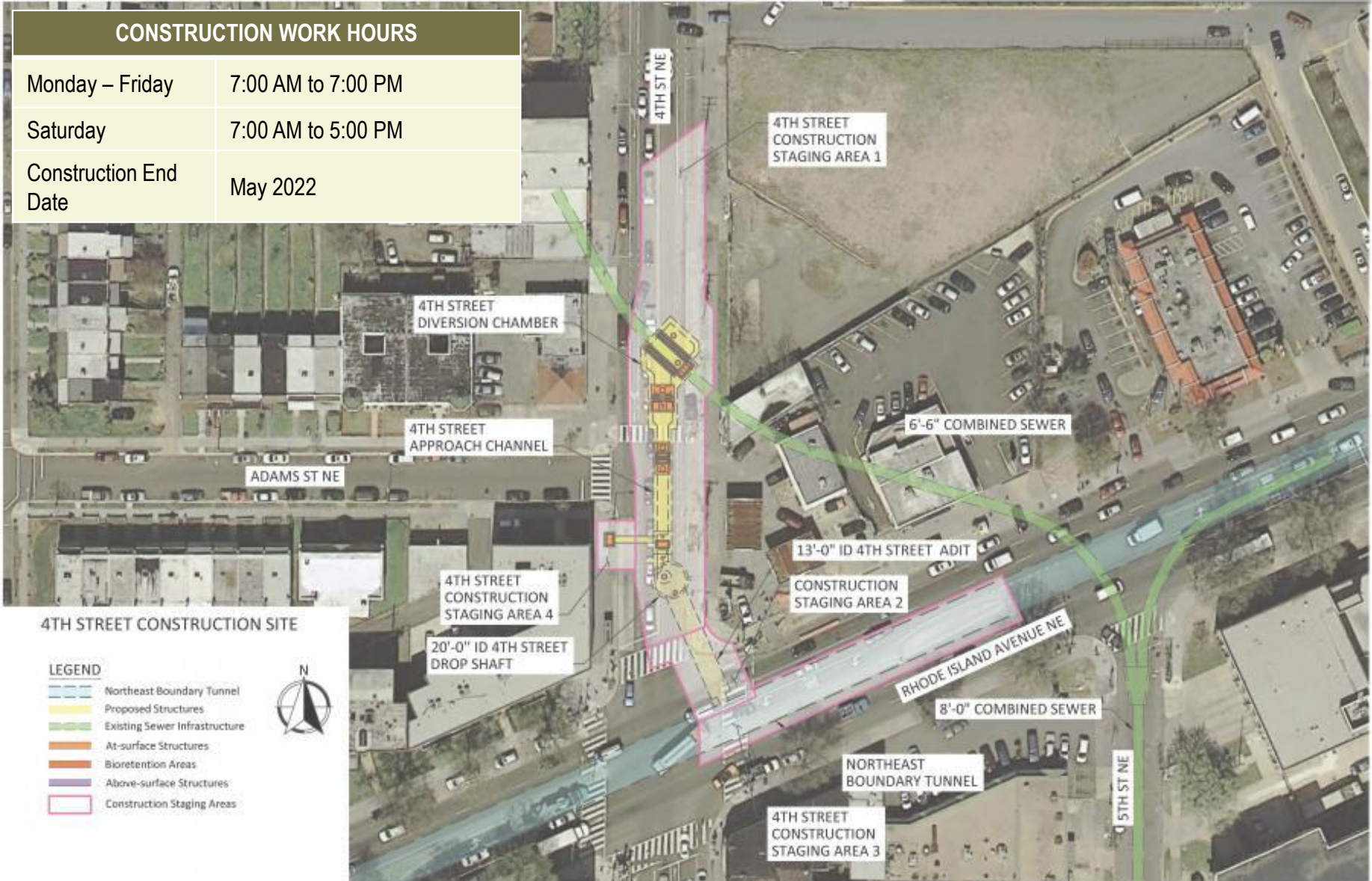

# What's Happening at the 4th Street NE Site

## Andrea Sesenna

### Current Activities:

Backfilling the Diversion Chamber. Installing concrete work in the Approach Channel– the structure will be finished by the end of September.

### Future Work:

In September, the contractor will construct a Drop Shaft lid. Afterwards, restoration work on the eastern half of 4<sup>th</sup> Street will begin in October and will take about a 2 ½ months to complete. Next, we will mobilize to a small construction site at the corner of Adams and 4<sup>th</sup> Streets. A portion of the work includes installing secant piles with about a 1 ½ week duration in the proximity of Emergent Preparatory Academy. This phase of work is expected to be completed in early 2022.

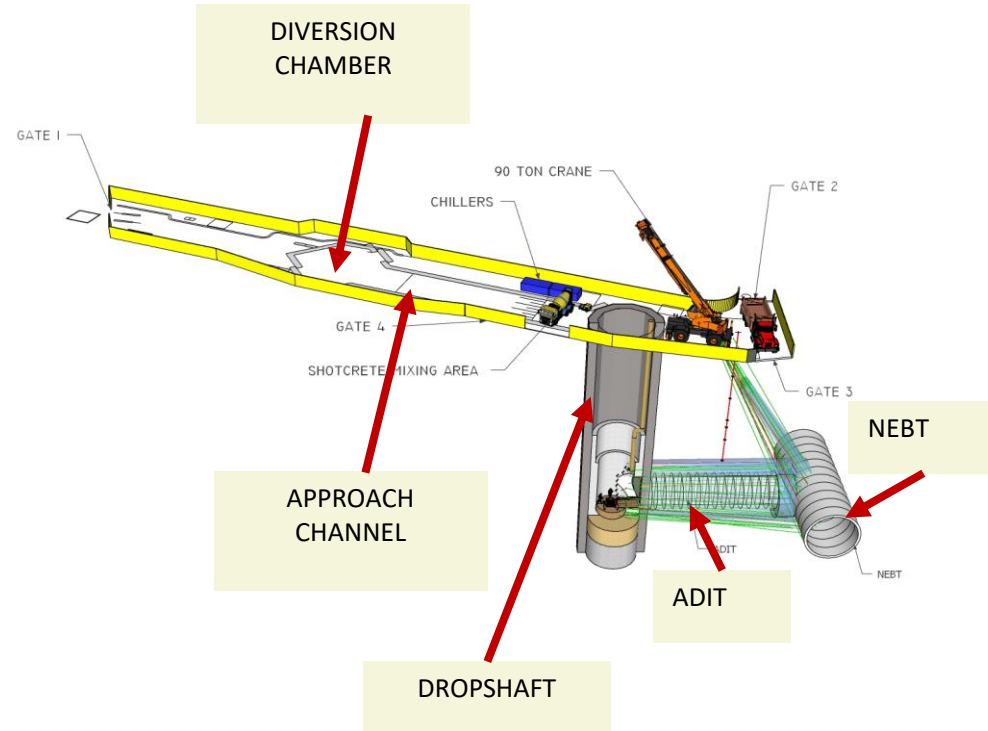

Map of the diversion facility at the 4<sup>th</sup> Street NE Construction Site



# 4<sup>th</sup> Street NE Construction Site: Traffic Pattern

## Matt Wolniak

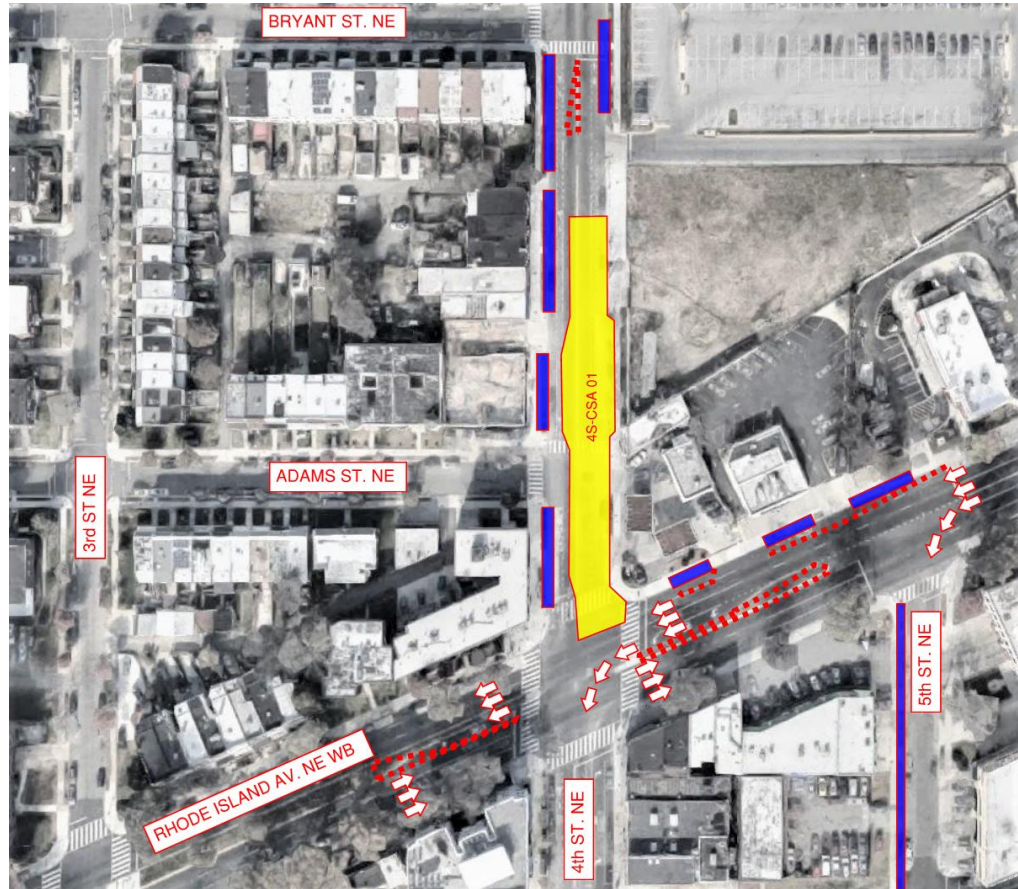

### 4<sup>TH</sup> STREET NE CONSTRUCTION SITE

TRAFFIC PATTERN:	The traffic pattern will change in early 2022.
MAIN IMPACT:	4 <sup>th</sup> Street NE closed to northbound traffic between Rhode Island Avenue NE and Bryant Street NE.

# 4<sup>th</sup> Street NE Construction Site: Pedestrian Detour

## Matt Wolniak



### 4<sup>TH</sup> STREET NE CONSTRUCTION SITE – Pedestrian Detour

PEDESTRIAN DETOUR: The pedestrian detour will continue into early 2022.

MAIN IMPACT: Pedestrian path provided around the construction site.



# 4th Street NE Construction Site: Traffic Pattern

## Matt Wolniak

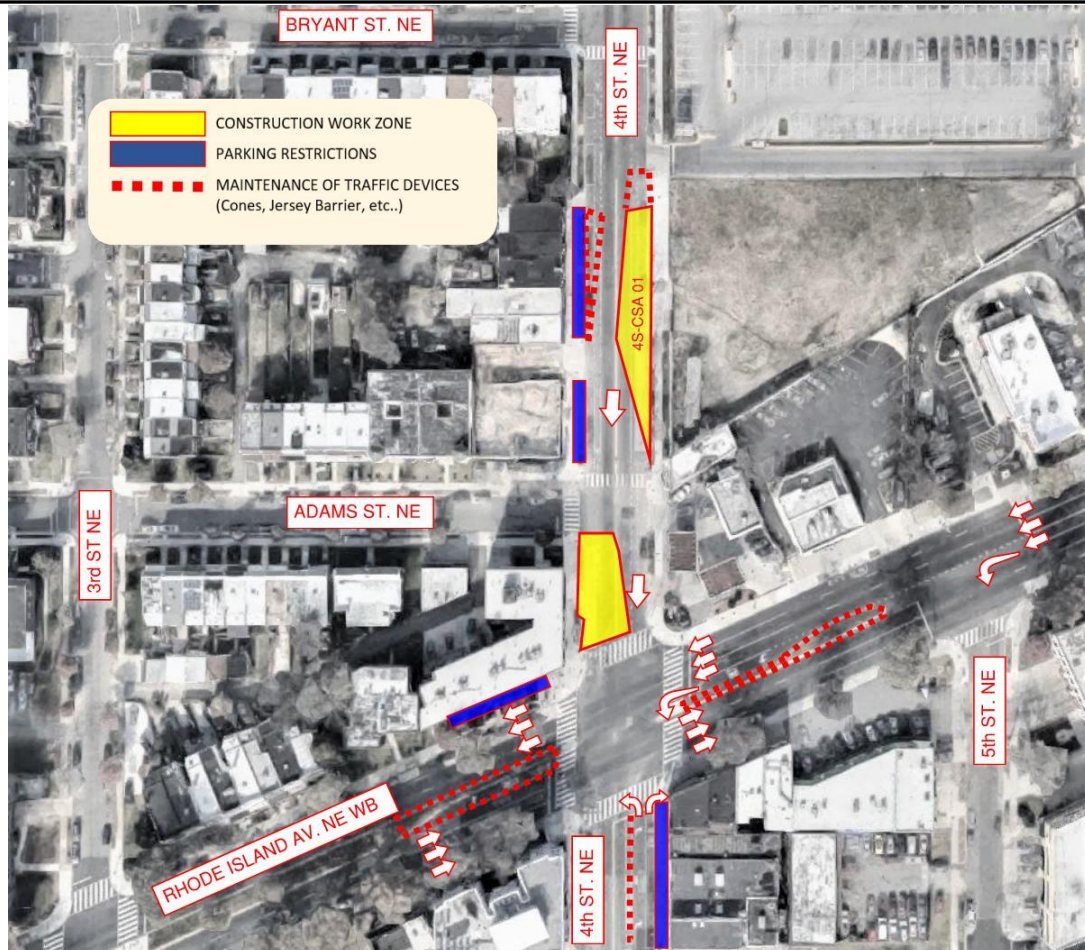

### 4<sup>TH</sup> STREET NE CONSTRUCTION SITE

TRAFFIC PATTERN:

The traffic pattern will begin in early 2022.

MAIN IMPACT:

4th Street NE closed to northbound traffic between Rhode Island Avenue NE and Bryant Street NE.



# Rhode Island Avenue NE Construction Site

## Andrea Sesenna

All construction dates are approximate and could change.

### CONSTRUCTION WORK HOURS

Monday - Friday	7:00 AM to 7:00 PM
Saturday (occasionally)	7:00 AM to 5:00 PM
Construction End Date	November 2022

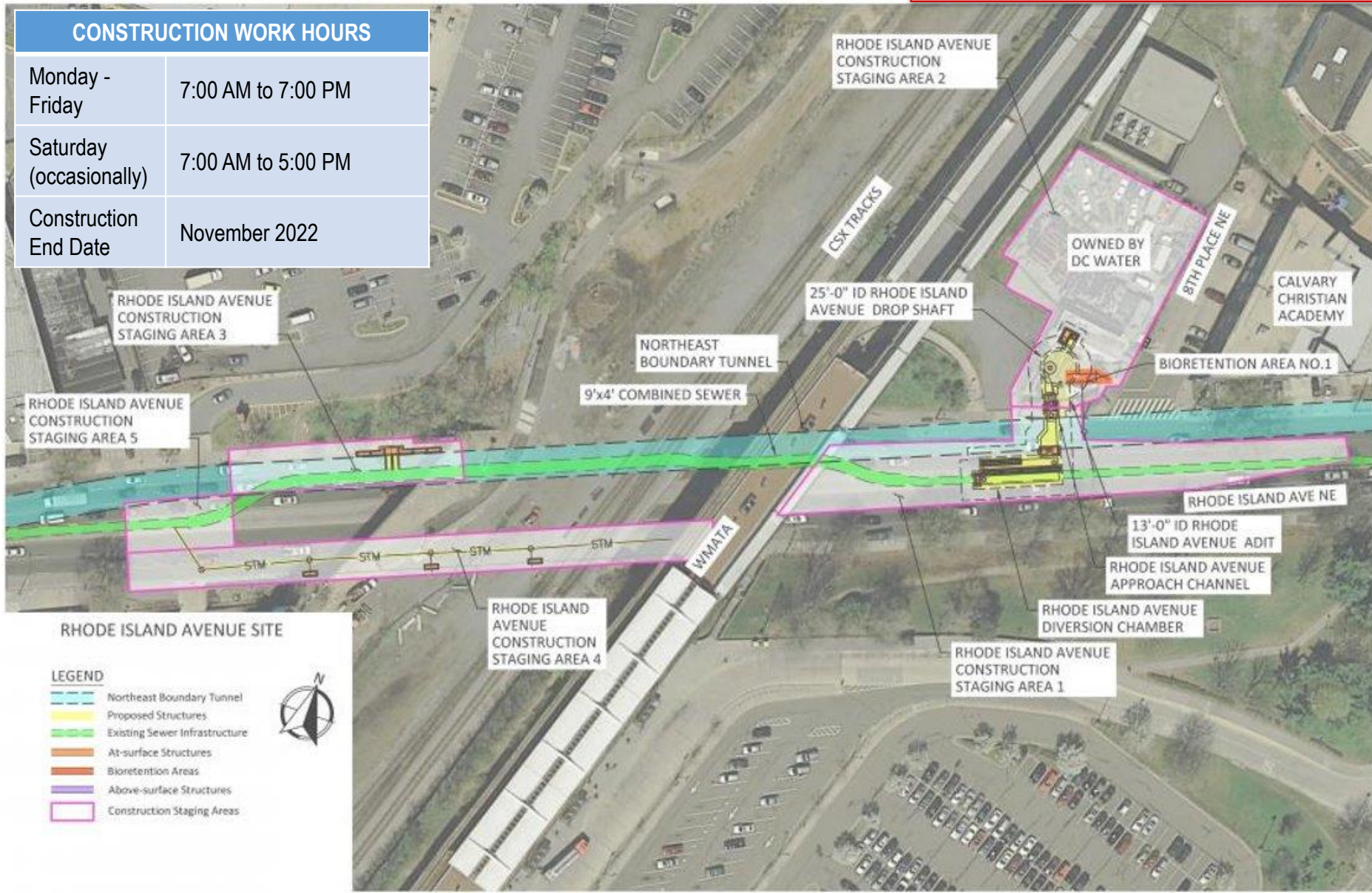



# What's Happening at the Rhode Island Ave NE Site

## Andrea Sesenna

### Current Activities:

Excavation of the Diversion Chamber is nearly complete and concrete work will follow. Excavating the Ventilation Vault for the next 3 weeks. Concrete work in the adit will continue for the next two months.

### Future Work:

Concrete work in the Drop Shaft and construction of the Inlet will begin in 2022. Approach Channel construction will start after the Diversion Chamber is completed.

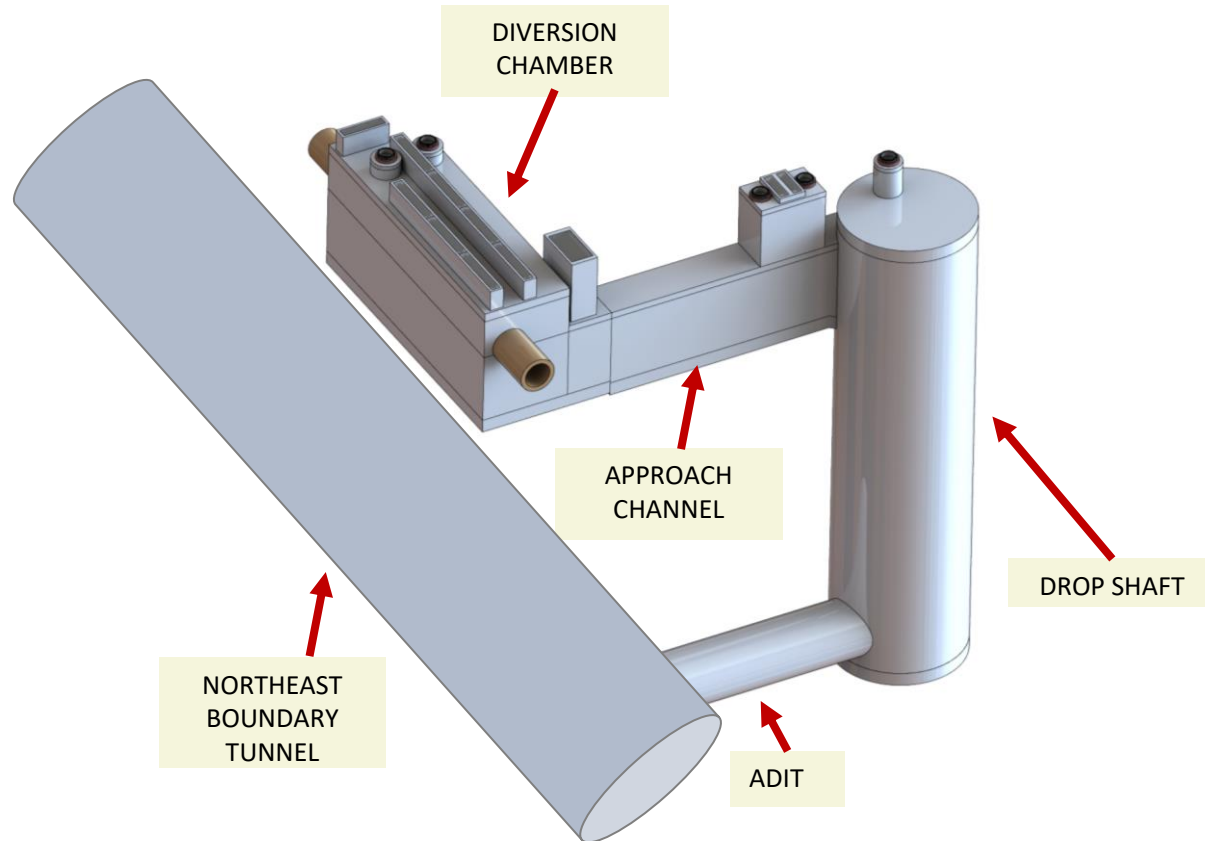

Map of the diversion facility at the Rhode Island Ave NE Construction Site

# Rhode Island Ave NE Construction Site: Traffic Pattern

## Matt Wolniak

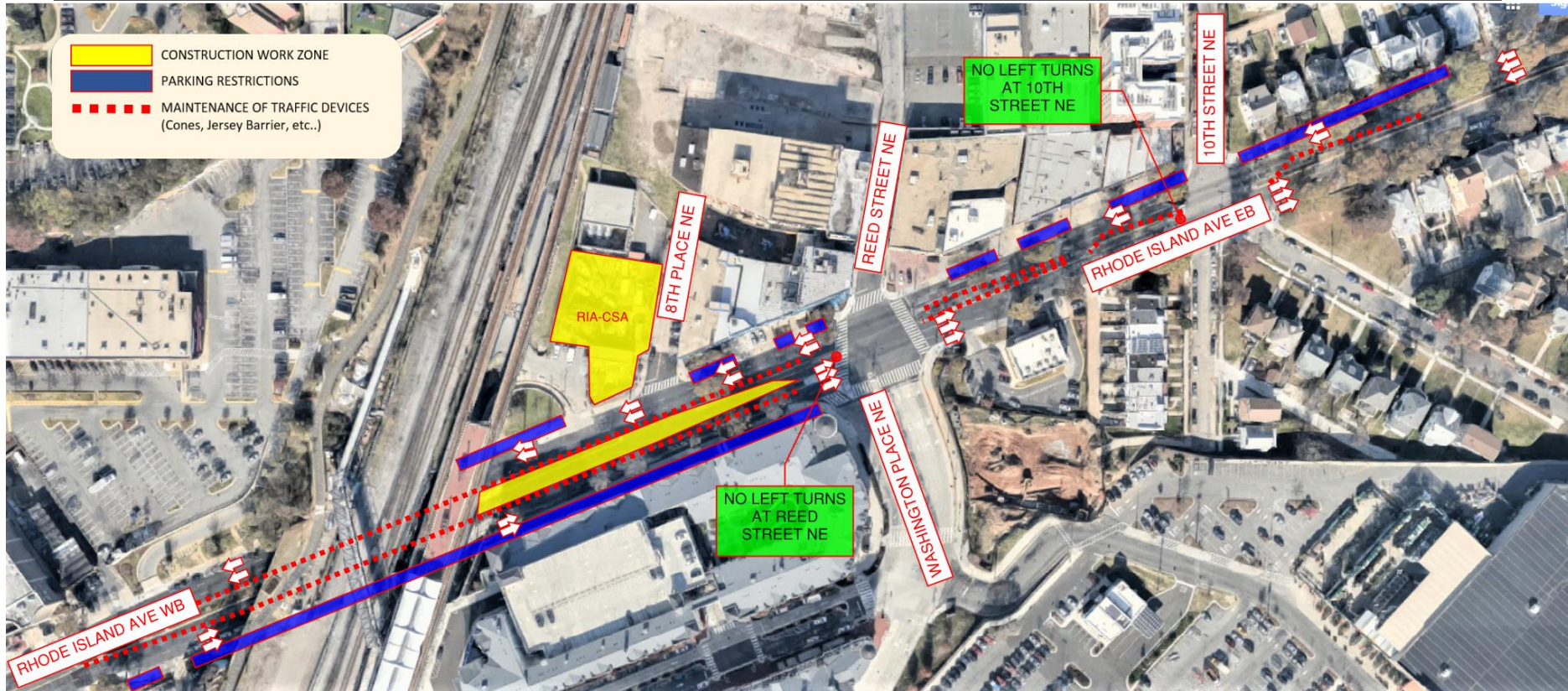

### RHODE ISLAND AVENUE NE CONSTRUCTION SITE

**TRAFFIC PATTERN:** The traffic pattern on Rhode Island Avenue NE will remain in the present configuration.

**MAIN IMPACT:** Two lanes in each direction on Rhode Island Avenue NE are routed to go around the construction area in middle lanes. **No left turns permitted from eastbound Rhode Island Ave to Reed Street and 10<sup>th</sup> Street.**

# NEBT Claims Process

## Hadiah Jordan

---

- If you are a property owner and you believe that construction activities undertaken as a result of this project have damaged your property in some way, you may send an **email** to [dccleanrivers@dcwater.com](mailto:dccleanrivers@dcwater.com) or **call the Hotline** at 800-988-6151.
- A representative of the contractor, SIH, will contact you to receive the information for the claim. A claim will be initiated on your behalf and a copy will be transmitted to you. Further communications about the claim will occur between the property owner and DC Water's insurance company.
- The claim receives a claim number, and an adjuster investigates.
- It is recommended that when you see damage, report it.

# Please Support Your Local Businesses

## Bill Levy



**OPEN FOR BUSINESS!**

**Emergent Prep Academy**  
**Sosnick's Liquor**

**BP**  
**GP Auto Services**  
**Huacatay**

**Nail Works Beauty Supply**  
**Edgewood Liquors**

**NORTHEAST BOUNDARY TUNNEL HOTLINE**  
(800) 988-6151 | [dcwater.com/NEBT](http://dcwater.com/NEBT)

**dc clean RIVERS PROJECT**

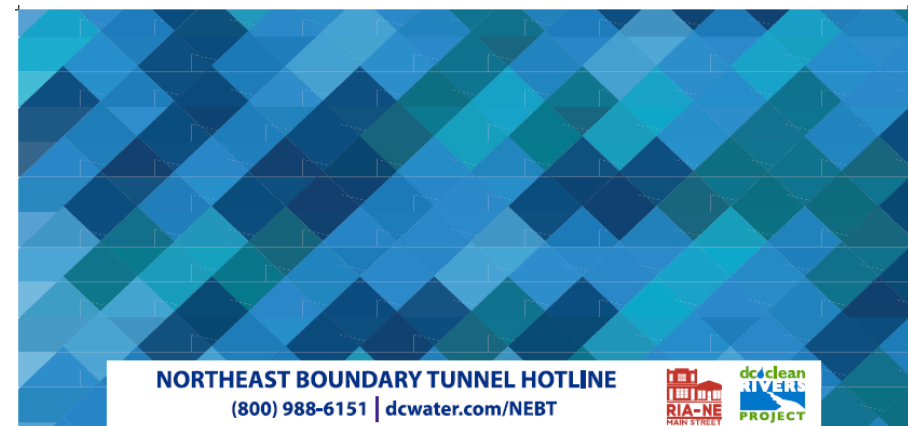

**NORTHEAST BOUNDARY TUNNEL HOTLINE**  
(800) 988-6151 | [dcwater.com/NEBT](http://dcwater.com/NEBT)

**dc clean RIVERS PROJECT**

New scrim design to be posted on the 4<sup>th</sup> Street NE construction site fence.



# Rhode Island Avenue NE Main Street

## Bill Levy

---

**Kyle Todd, Executive Director**

[kyle@riamainstreet.org](mailto:kyle@riamainstreet.org)

202-808-9050

[riamainstreet.org](http://riamainstreet.org)

Office Location

2300 Rhode Island Avenue NE, Suite 202



# Contact Us!

## For More Info

- **24/7 NEBT Hotline:** (800) 988-6151
- **Email:** [dccleanrivers@dcwater.com](mailto:dccleanrivers@dcwater.com)
- **Project Webpage:** [dcwater.com/NEBT](http://dcwater.com/NEBT)

To receive email updates about NEBT construction, send an email to [dccleanrivers@dcwater.com](mailto:dccleanrivers@dcwater.com).



One of our local business partners, MBR, is hosting the temporary Van Gogh 360 Digital Art (VR) Exhibit, located at the Rhode Island Avenue Shopping Center. Check it out!

[vangoghexpo.com/washington/](http://vangoghexpo.com/washington/)



We will acknowledge questions from participants who are online and on the phone.



- **ONLINE PARTICIPANTS:** send your questions to the Host by using the Chat mode. You may also click on “Participants” to raise your hand for a question.
- **PHONE PARTICIPANTS:** press \*9 to alert us that you want to ask a question. We will unmute you when it’s your turn to ask a question.