



**District of Columbia
Water and Sewer Authority**
Serving the Public • Protecting the Environment

Blue Plains Total Nitrogen Removal / Wet Weather Plan

Long Term Control Plan Supplement No. 1



Final

October 2007

METCALF & EDDY | AECOM

 **GREELEY AND HANSEN**

 **Limno-Tech, Inc.**

Table of Contents

DISTRICT OF COLUMBIA
WATER AND SEWER AUTHORITY
Washington, D.C.

Blue Plains Total Nitrogen Removal / Wet Weather Plan Long Term Control Plan Supplement No. 1

Table of Contents

Metcalf & Eddy, Greeley and Hansen LLC, Limno Tech, Inc.
October 2007

SUMMARY AND FINDINGS	S-1
SECTION 1 - INTRODUCTION	1-1
1.1 PURPOSE	1-1
1.2 BACKGROUND	1-1
1.2.1 Blue Plains Advanced Wastewater Treatment Plant.....	1-1
1.2.2 Wastewater Collection System	1-2
1.2.3 Long Term Control Plan	1-4
1.3 REGULATORY REQUIREMENTS.....	1-6
1.3.1 Chesapeake Bay Program	1-6
1.3.2 NPDES Permit	1-7
1.3.3 Consent Decrees	1-8
1.3.4 Total Maximum Daily Loads (TMDLs)	1-11
1.4 TN/WET WEATHER PLAN GOALS	1-11
SECTION 2 – BLUE PLAINS PROCESS EVALUATION	2-1
2.1 INTRODUCTION	2-1
2.2 BASIS OF DESIGN	2-3
2.2.1 Average Annual Plant Influent Flows.....	2-3
2.2.2 Maximum Month Plant Influent Flows.....	2-3
2.2.3 Average Plant Influent Loads	2-6
2.2.4 Maximum Month Plant Influent Loads.....	2-7
2.3 DESCRIPTION AND EVALUATION OF EXISTING FACILITIES	2-7
2.3.1 Basis for Process and Facility Evaluations	2-9
2.3.2 Preliminary Treatment Process	2-10
2.3.3 Primary Treatment Process	2-11
2.3.4 Excess Flow Treatment Facilities	2-14
2.3.5 Secondary Treatment Processes.....	2-14
2.3.6 Nitrification/Denitrification Treatment Process	2-18
2.3.7 Dual Purpose Sedimentation Basins	2-23
2.3.8 Filtration and Disinfection Facility	2-24
2.3.9 Primary Sludge Screening and Degritting Process	2-24
2.3.10 Gravity Thickening Process.....	2-25
2.3.11 Dissolved Air Flotation Thickening Process	2-25
2.3.12 Anaerobic Digestion Process	2-25
2.3.13 Sludge Dewatering, Post-Liming and Storage Process.....	2-26
2.3.14 Plant-wide Chemical Systems – Chlorination Systems	2-26
2.3.15 Plant-wide Chemical Systems – Dechlorination Systems	2-27

Table of Contents

2.3.16	Plant-wide Chemical Systems – Metal Salts Addition	2-27
2.3.17	Plant-wide Chemical Systems – Dry Polymer System	2-28
2.4	SUMMARY OF PROCESS EVALUATIONS	2-28
2.5	NITROGEN REMOVAL ALTERNATIVES	2-29
2.5.1	Enhanced Clarification Facility	2-29
2.5.2	Reduce Hydraulic Load on Sedimentation Basins in the Biological System ...	2-31
2.5.3	Improve Biological Nitrogen Removal System	2-33
SECTION 3 – COLLECTION SYSTEM AND RECEIVING WATER EVALUATION		3-1
3.1	INTRODUCTION	3-1
3.2	RAINFALL CONDITIONS	3-1
3.3	COLLECTION SYSTEM CHARACTERIZATION	3-1
3.3.1	Combined/Sanitary Sewer System Model	3-1
3.3.2	Separate Storm Water System Model	3-4
3.3.3	Event Mean Concentrations	3-4
3.4	RECEIVING WATER CHARACTERIZATION	3-5
SECTION 4 - ALTERNATIVES EVALUATION		4-1
4.1	INTRODUCTION	4-1
4.2	DESCRIPTION OF ALTERNATIVES	4-2
4.2.1	Alternative A	4-2
4.2.2	Alternative B	4-2
4.2.3	Alternative C	4-2
4.2.4	Alternative D	4-3
4.2.5	Alternative E	4-3
4.3	EVALUATION OF ALTERNATIVES	4-4
4.3.1	General	4-4
4.3.2	Predicted Blue Plains Flows and Loads	4-10
4.3.3	Predicted Potomac River Water Quality	4-11
4.3.4	Predicted CSO Overflows to Anacostia River	4-12
4.3.5	Schedule to Implement	4-12
4.3.6	Cost Opinions	4-12
4.3.7	Qualitative Factors	4-12
SECTION 5 – RECOMMENDED PLAN		5-1
5.1	INTRODUCTION	5-1
5.2	RECOMMENDED PLAN	5-1
5.3	PREDICTED PERFORMANCE OF RECOMMENDED PLAN	5-4
5.4	SCHEDULE	5-5
5.5	OUTFALL 001 NITROGEN ALLOCATION AND PERMITTING APPROACH	5-7
5.6	INTERIM FLOW LIMITS AT BLUE PLAINS	5-6
5.7	NPDES PERMIT CONDITIONS	5-9
5.8	CONSENT DECREE MODIFICATIONS	5-7

Table of Contents

APPENDICES

No.	Title
A	Plant Influent Flows and Loads Technical Memorandum
B	Blue Plains Strategic Plan Process Modeling Technical Memorandum
C	Process Model Calibration Report
D	Wet Weather Treatment Technical Memorandum Impact of Wet Weather Events on Plant Operations of the Biological Nitrogen Removal
E	Process
F	Responses to Comments

LIST OF TABLES

Table No.	Title of Table	Page No.
S-1	Flows to be Treated at Blue Plains Under Existing NPDES Permit	S-4
S-2	Comparison of Alternatives	S-10
S-3	EPA's Derivation of TN Limit for Blue Plains.....	S-14
S-4	Proposed TN Load Allocation – Outfall 001 as a CSO Bypass or CSO.....	S-15
1-1	Final LTCP Components	1-4
1-2	CSO Overflow Reduction of Final LTCP (Average Year).....	1-6
1-3	EPA's Bases for TN Limit at Blue Plains.....	1-7
1-4	NPDES Permitted Flow Limits.....	1-8
1-5	Excerpt of LTCP Decree Deadlines.....	1-10
1-6	TMDLs Issued for District Waters Receiving CSO Discharges.....	1-11
2-1	Projected Average Annual Flow to Blue Plains.....	2-3
2-2	Projected Average Annual Blue Plains Influent Flows and Loads.....	2-3
2-3	Projected Monthly Blue Plains Plant Influent Flows and Loads	2-7
2-4	Process Facilities and Equipment at Blue Plains	2-8
2-6	Primary Treatment Process Detention Time and Loading Rates	2-13
2-7	Industry Standards for Secondary Sedimentation Basin Hydraulic Loading Rates...	2-16
2-8	Industry Standards for Nitrification Sedimentation Basin Hydraulic Loading Rates.....	2-23
2-9	Expected Removal Efficiencies of Primary Sedimentation Basins at Peak Influent Flow = 1,076 mgd	2-30
2-10	Maximum Recommended Flow Based on Hydraulic Load	2-32
3-1	Annual Average Rainfall Conditions in the District	3-1
3-2	Event Mean Concentrations for CSO and Separate Storm Water.....	3-4
4-1	Summary of Alternatives	4-9
4-2	Event Mean Concentrations for Blue Plains Effluent	4-11
4-3	Qualitative Factors	4-14
5-1	Predicted Performed of Recommended Plan in Average Year	5-4
5-2	EPA's Derivation of TN Limit for Blue Plains.....	5-7
5-3	Proposed TN Load Allocation – Outfall 001 as a CSO Bypass or CSO.....	5-8

Table of Contents

LIST OF FIGURES

Figure No.	Title of Figure	Page No.
S-1	Existing Long Term Control Plan.....	S-2
S-2	Blue Plains Process Flow Diagram.....	S-3
S-3	General Approaches to Complying with Total Nitrogen Effluent Limit.....	S-6
S-4	Alternative Projects	S-8
S-5	Recommended Plan	S-12
1-1	Blue Plains Site Plan.....	1-3
1-2	Long Term Control Plan.....	1-5
2-1	Blue Plains Process Flow Diagram.....	2-2
2-2	Daily Average Influent Flow 2002/3.....	2-4
2-3	Average Diurnal Patterns (Dry Weather)	2-5
2-4	Blue Plains Monthly Influent Flow 2002-2004	2-5
2-5	Primary Sedimentation Tank Testing 2004	2-13
2-6	Secondary Process Operating Modes	2-17
2-7	Historical Performance of Nitrogen Removal at Blue Plains	2-20
2-8	Nitrification/Denitrification Process Operating Modes	2-22
2-9	Proposed Process Flow Diagram	2-30
2-10	Minimum Average Monthly Temperatures	2-37
2-11	Monthly 002 Nitrogen Discharges.....	2-37
3-1	CSS Model in MIKE URBAN.....	3-3
4-1	Alternative B.....	4-5
4-2	Alternative C.....	4-6
4-3	Alternative D	4-7
4-4	Alternative E.....	4-8
5-1	Recommended Plan	5-3

Summary and Findings

Purpose

The District of Columbia Water and Sewer Authority (WASA or Authority) provides wastewater collection and treatment for the District of Columbia, and wastewater treatment for surrounding areas including parts of suburban Virginia and Maryland at the District's Advanced Wastewater Treatment Plant at Blue Plains (Blue Plains). On April 5, 2007, the United States Environmental Protection Agency (EPA) issued a modification to WASA's National Pollutant Discharge Elimination System (NPDES) permit. The permit modification includes a total nitrogen effluent limit for Blue Plains of 4.689 million pounds per year. The total nitrogen limit was developed by EPA to achieve the goals of the Chesapeake Bay Program for nutrient reductions.

In addition to meeting the new effluent limit for total nitrogen, WASA has existing NPDES Permit requirements for treating wet weather flows at Blue Plains. The latter requirement is part of WASA's Long Term Control Plan (LTCP) for the combined sewer system. On April 13, 2007, WASA submitted a Draft Total Nitrogen Removal/Wet Weather Plan (TN/WW Plan) to EPA. The purpose of the report was to present WASA's approach to meet the new total nitrogen effluent limit and to comply with its existing permit conditions to treat wet weather flows. After submittal of the draft plan, a public participation program was conducted to solicit comments on the plan. The program included a notice in the Washington Post, making information available at public information depositories and WASA's web site, and holding an informational meeting and a public meeting. This report is WASA's Final TN/WW Plan and includes a summary of the public participation program and responses to comments in Appendix F.

Background

The suburban sewer systems in the Blue Plains service area consist of separate sanitary and storm sewers. In the District, the sewer system is comprised of both combined sewers and separate sanitary sewers. A combined sewer carries both sewage and runoff from storms. Modern practice is to build separate sewers for sewage and storm water, and no new combined sewers have been built in the District since the early 1900's. Approximately one-third of the District (12,478 acres) is served by combined sewers. The majority of the area served by combined sewers is in the older developed sections of the District.

In the combined sewer system, sewage from homes and businesses during dry weather conditions is conveyed to Blue Plains, which is located in the southwestern part of the District on the east bank of the Potomac River. There, the wastewater is treated to remove pollutants before being discharged to the Potomac River. When the capacity of a combined sewer is exceeded during storms, the excess flow, which is a mixture of sewage and storm water runoff, is discharged to the Anacostia and Potomac Rivers, Rock Creek and tributary waters. The excess flow is called Combined Sewer Overflow (CSO). There are a total of 53 CSO outfalls in the combined sewer system listed in WASA's NPDES Permit.

In accordance with the 1994 CSO Policy, WASA submitted a Final LTCP to EPA in 2002. The District of Columbia Department of the Environment (DOE) (formerly Department of Health) and EPA approved the Final LTCP and determined that CSOs remaining after implementation of the plan "...will not preclude the attainment of water quality standards or the receiving waters' designated uses or contribute to their impairment", subject to post construction monitoring. WASA is currently implementing the LTCP in accordance with a Consent Decree entered by the United States District Court for the District of Columbia on March 23, 2005. The existing LTCP is shown on Figure S-1.

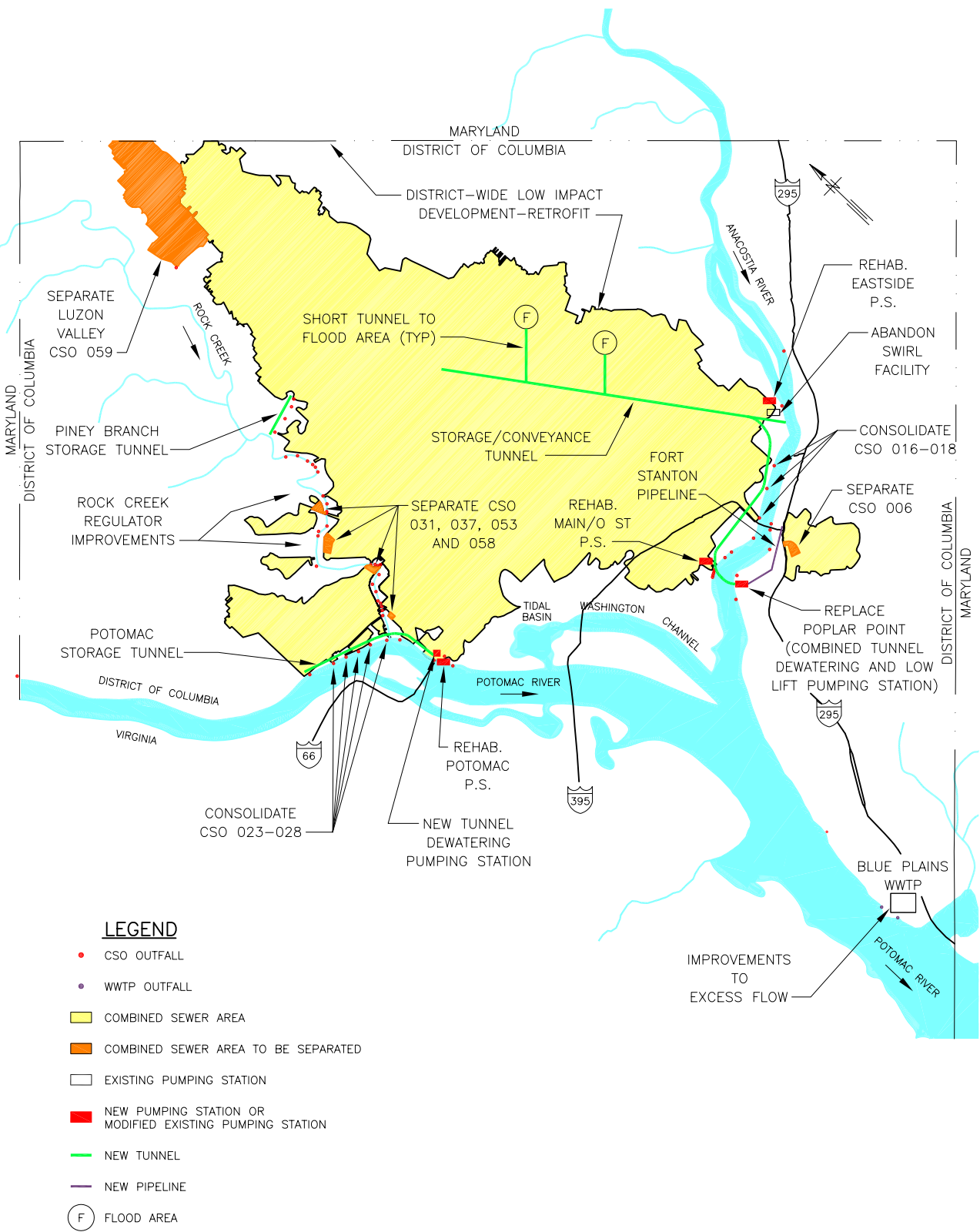

EXISTING LONG TERM CONTROL PLAN

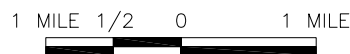

METCALF & EDDY
 GREELEY AND HANSEN LLC
 LIMNO-TECH, INC

D.C. WATER AND SEWER AUTHORITY
 TOTAL NITROGEN/WET WEATHER PLAN

H:\1160\BP Strategic Plan\TN_WW Plan\Report-Draft\Dwg\Fig 1-2 LTCP.DWG

Summary and Findings

When the LTCP was finalized in 2002, there was no effluent limit for total nitrogen in WASA's NPDES permit for Blue Plains and, the LTCP provided that imposition of a total nitrogen limit could require a modification of the LTCP and its implementation schedule. Evaluations have now been made to assess the impact of adding the new total nitrogen effluent limit on top of the LTCP and existing NPDES permit requirements for treating wet weather flows. Evaluations have been made to review the LTCP requirements and existing permit conditions to provide an environmentally protective, practicable, reliable and economically balanced plan for meeting the new total nitrogen effluent limit while controlling CSOs to at least the degree provided by the approved LTCP.

Blue Plains Process Evaluations

Process evaluations have been made of the existing facilities at Blue Plains to determine needs to meet the new total nitrogen effluent limit and existing NPDES Permit conditions for treating wet weather flows. The existing facilities at Blue Plains comprise the basic liquid treatment processes as follows:

- Initial Treatment Facilities, which include screening, pumping, grit removal and primary clarification.
- Complete Treatment Facilities, which are downstream of the Initial Treatment Facilities and include secondary and advanced biological treatment, filtration, chlorination and dechlorination with discharge from Outfall 002. Any flow receiving Complete Treatment receives treatment to a greater degree than required by the regulatory definition of secondary treatment.
- Excess Flow Treatment, which comprises Initial Treatment followed by chlorination and dechlorination with discharge from Outfall 001.

The general arrangement of the existing facilities is shown on Figure S-2. Under the existing NPDES Permit, the facilities shown on Figure S-2 are required to handle and treat flows received at Blue Plains as shown in Table S-1.

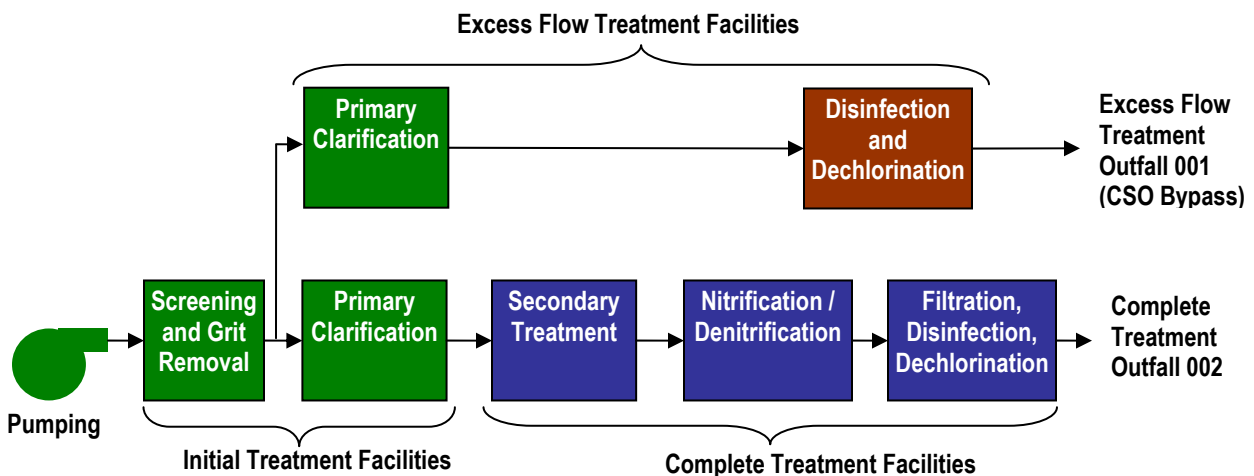

Figure S-2
Blue Plains Process Flow Diagram

Summary and Findings

**Table S-1
Flows to be Treated at Blue Plains under Existing NPDES Permit**

<i>Treatment System</i>	<i>Flows to be Treated During Conditions of:</i>	
	<i>Dry Weather</i>	<i>Wet Weather¹</i>
Initial Treatment	370 mgd, Annual Average	Up to 1076 mgd
Complete Treatment	370 mgd, Annual Average	740 mgd, first 4 hours 511 mgd, continuous ²
Excess Flow Treatment ³	-	Up to 336 mgd

Notes:

1. A wet weather event is deemed to start when plant influent is greater than a rate of 511 mgd and deemed to stop four hours after plant influent drops to a rate of 511 mgd or a period of 4 hours has elapsed since the start of a wet weather event, whichever occurs last.
2. 511 mgd is the peak dry weather flow rate (maximum day rate for the annual average rate of 370 mgd). Complete treatment facilities provide better than secondary treatment for flow rates greater than the peak dry weather flow rate. Flow rates to complete treatment are reduced after the first four hours of wet weather conditions to protect the biological processes.
3. The discharge from excess flow treatment (Outfall 001) is authorized as a CSO Bypass to protect the complete treatment system and because it is not technically feasible to provide treatment for greater wet weather flows for longer periods.

There is a project included in the LTCP to upgrade the Excess Flow Treatment facilities by the addition of four new primary clarifiers and improved hydraulic controls.

Operating experience and process evaluations have demonstrated that providing complete treatment to peak flows of 740 mgd during wet weather conditions has a detrimental effect on the treatment processes. During periods when peak flow rates in the range of 600 to 740 mgd are conveyed to primary, secondary and advanced treatment facilities, performance of clarification units deteriorates due to the severe impact of the hydraulic loadings created by peak flows. Deterioration of performance cascades from one treatment train to the next (e.g. primary to secondary to advanced) and results in a pervasive impact that continues during the wet weather condition and for as much as several weeks thereafter. While the existing facilities have the capacity to accommodate the existing permit peak flow rates, additional facilities will be required to treat the existing permit peak flow rates without any nitrogen removal and meet the new total nitrogen effluent limit.

Because the existing facilities at Blue Plains do not have capacity to simultaneously meet existing NPDES Permit conditions for wet weather flow treatment and the new total nitrogen effluent limit, alternative projects have been developed and evaluated. Projects to meet the new total nitrogen effluent limit and accommodate wet weather flow conditions have been developed based on the general treatment approaches as shown on Figure S-3 and the principal criteria as follows:

- Continue to deliver a wet weather peak flow of up to 1076 mgd to Blue Plains
- Evaluate peak flow distribution during wet weather events for conditions as follows:

<i>Treatment Process</i>	<i>Flow Distribution - mgd</i>		
	<i>Maintain Current Peak Flow Rates</i>	<i>Reduce Peak Flow Rates</i>	<i>Reduce Peak Flow Rates and Add Storage</i>
Complete Treatment	740 ¹ , first 4 hours 511, thereafter	555 ² , first 4 hours 511, thereafter	555 ² , first 4 hours 511, thereafter
Excess Flow Treatment	Up to 336	Up to 521 mgd	Up to 225 mgd

- Notes:
1. 740 mgd provides for a peak rate of 2.0 times the annual average flow of 370 mgd
 2. 555 mgd provides for a peak rate of 1.5 times the annual average flow of 370 mgd

Summary and Findings

- Combined Sewer System Flow (CSSF) conditions (this constitutes wet weather conditions) exist when the total flow conveyed to the Blue Plains headworks exceeds 511 mgd. CSSF conditions stop when the total flow conveyed to the Blue Plains headworks falls to less than 511 mgd or a period of four hours has elapsed from the start of a CSSF condition; whichever occurs last.
- When CSSF conditions exist, flow conveyed to the Blue Plains headworks receives Complete Treatment and Excess Flow Treatment according to the flow distribution listed in the table above and is discharged from Outfalls 001 and 002.
- When CSSF conditions do not exist, flow conveyed into the Blue Plains headworks is all discharged from Outfall 002 after receiving Complete Treatment
- The predicted quality of the average year combined effluent discharged from Outfalls 001 and 002 will equal or exceed the quality predicted for the LTCP.
- Depending on the alternative, Outfall 001 may serve as a CSO bypass or as a CSO.
- Excess flow treatment will be based on primary clarification using plain sedimentation and enhanced clarification facilities (ECF) employing ballasted flocculation technology. The effluent quality from ECF has been demonstrated as being of a higher quality (e.g. lower pollutant load) compared to that produced by plain sedimentation.
- For an arrangement where the tunnels system is extended to Blue Plains, additional storage will be provided to capture peak flow rates and store such flow prior to delivery to the Blue Plains headworks. Storage capacity has been based on providing tunnel capacity for the difference in the peak flow rates conveyed to Complete Treatment (740 mgd vs. 555 mgd) during the first four hours of a wet weather condition. The tunnel volume required is 740 mgd less 555 mgd which equals 185 mgd for four hours, or 31 million gallons (mg). When additional storage is provided by the tunnel extension, the peak treatment rate at Blue Plains can be reduced to less than 1076 mgd because the storage can be used to equalize the rate being treated while producing an overall effluent quality discharged from Outfalls 001 and 002 of equal or better than that predicted for the LTCP. For an additional storage capacity of 31 mg, the studies show that excess flow treatment employing ECF at a capacity of 225 mgd or an overall peak treatment flow rate of 780 mgd (555 + 225) can be expected to produce an average year effluent quality equal to that produced by treating a peak rate of 1076 mgd (555 + 521 or 740 + 336) without adding additional storage.
- The tunnels system will be arranged to be dewatered during and after a storm for treatment at Blue Plains according to the flow distribution table above and whether or not CSSF conditions exist.
- New biological nitrogen removal facilities (enhanced nitrogen removal or ENR) will be provided with sufficient biological and hydraulic capacity to meet the new total nitrogen effluent limit based on the flow distribution table above and CSSF conditions.

Summary and Findings

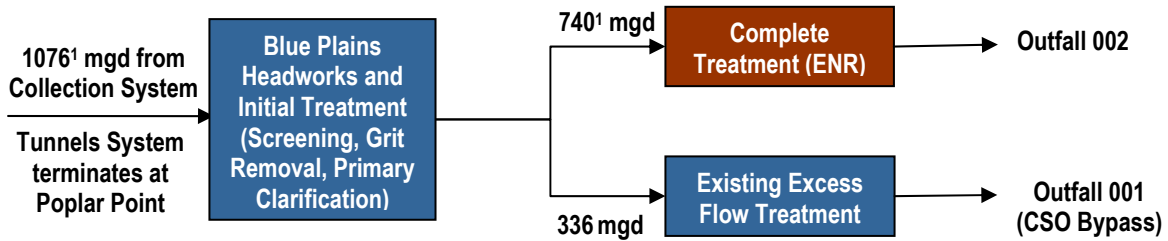

Maintain Current Peak Flow Rates to Complete Treatment

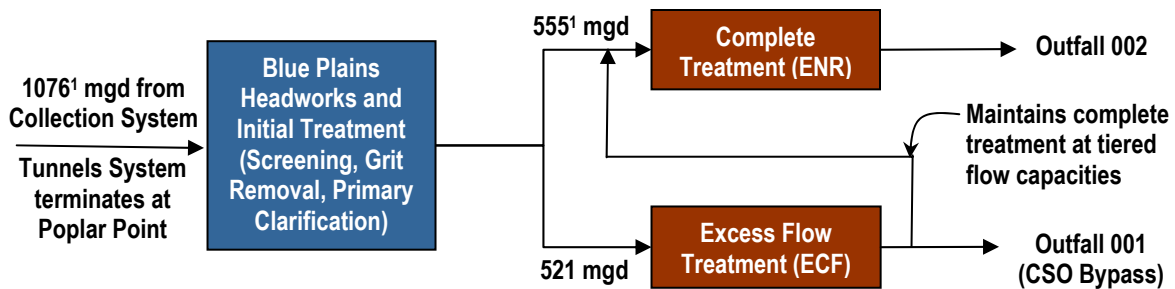

Reduce Peak Flow Rate to Complete Treatment and Add Enhanced Clarification for Excess Flow Treatment

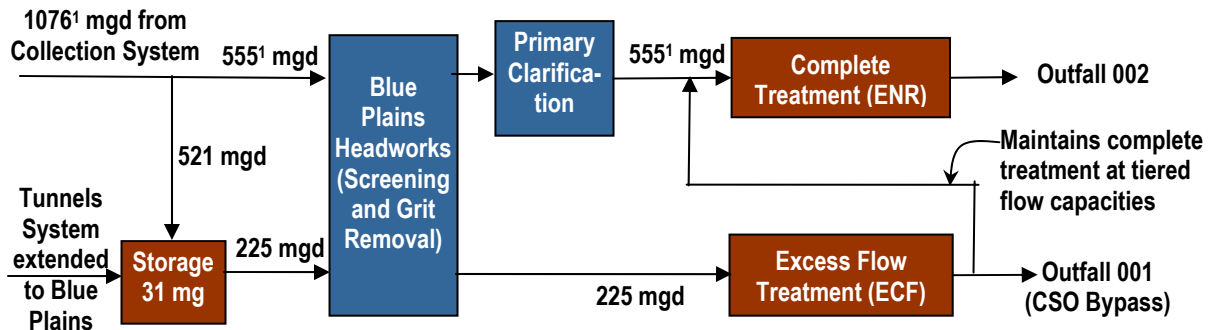

Reduce Peak Flow Rate to Complete Treatment, Add Storage and Enhanced Clarification for Excess Flow Treatment

Notes: 1. Flow Rates during first four hours of a wet weather event

**Figure S-3
General Approaches to Complying with Total Nitrogen Effluent Limit**

Collection System and Receiving Water Evaluations

The same analytical procedures used to develop and evaluate the LTCP were used to evaluate the alternative TN/WW plans. The model of the combined sewer system developed and calibrated during the LTCP was used to predict flows and loads to Blue Plains and the CSOs. Models of the receiving waters developed and calibrated during the LTCP were used to predict the water quality of alternative TN/WW plans. Alternatives were evaluated on the basis of the average climatic year. This was the period 1988, 1989 and 1990, which is the same period used to develop the LTCP and period used by EPA and D.C. DOE to develop TMDLs for the receiving waters in the District.

Alternative Projects for Total Nitrogen Removal/Wet Weather Treatment

A series of alternative projects have been developed to compare the technical designs for meeting the new total nitrogen effluent limit and providing sufficient wet weather treatment capacity at Blue Plains to accommodate performance requirements of the LTCP. The alternative projects are diagrammed on Figure S-4 and are described briefly as follows:

- Alternative A – This project is the same as the excess flow improvements in the LTCP. This alternative comprises the addition of four new primary clarifiers for Excess Flow Treatment together with improved hydraulic controls. During wet weather conditions, a peak flow rate of 740 mgd would continue to be conveyed to Complete Treatment for the first four hours. After four hours, the rate to Complete Treatment would be reduced to 511 mgd and up to 336 mgd would be treated in the excess flow facilities during wet weather conditions. This alternative would not have the hydraulic or biological capacity in the initial and complete treatment facilities needed to meet the new total nitrogen effluent limit for Outfall 002. Therefore, this alternative has not been included in the comparison of alternative projects.
- Alternative B – This alternative adds the new total nitrogen effluent limit on top of the existing permit conditions for treating wet weather flows under the LTCP. Flow to complete treatment would be 740 mgd for the first 4 hours and 511 mgd thereafter. A maximum of 336 mgd would receive excess flow treatment (primary clarification and disinfection) and be discharged from Outfall 001. In order to meet the new total nitrogen effluent limit and existing permit conditions for treating wet weather flows, new and expanded biological and hydraulic capacity would be required for the treatment facilities at Blue Plains. Because of site restrictions and complexities related to interfacing new and existing facilities, the improvements needed to implement this alternative, while technically feasible on paper, would involve a substantial degree of uncertainty with respect to long term reliability. For example, the improvements needed would likely require constructing stacked (double-deck) clarifiers and complex flow distribution to physically separated treatment units.
- Alternative C – Under this alternative, peak flow rates to Complete Treatment would be reduced to 555 mgd for the first 4 hours and 511 mgd thereafter. The difference in the maximum rate (1076 mgd) conveyed to the headworks at Blue Plains and that to be conveyed to Complete Treatment (555 mgd) is 521 mgd. New ECF would be constructed with a capacity of 521 mgd to handle the reduction in peak flow to Complete Treatment. The Anacostia River Tunnels System would remain the same as included in the existing LTCP. The tunnels dewatering pumping station at Poplar Point would, however, pump into a force main that would convey flow captured in the tunnels to new headworks at Blue Plains for treatment in the new ECF. Operating provisions would involve arrangements to dewater the tunnels system during and following wet weather events and to convey the ECF effluent to Outfall 001 and/or Complete Treatment depending on the capacity available in the Complete Treatment facilities. New enhanced nitrogen removal (ENR) facilities would be constructed at Blue Plains with capacity to meet the new total nitrogen effluent limit.

Summary and Findings

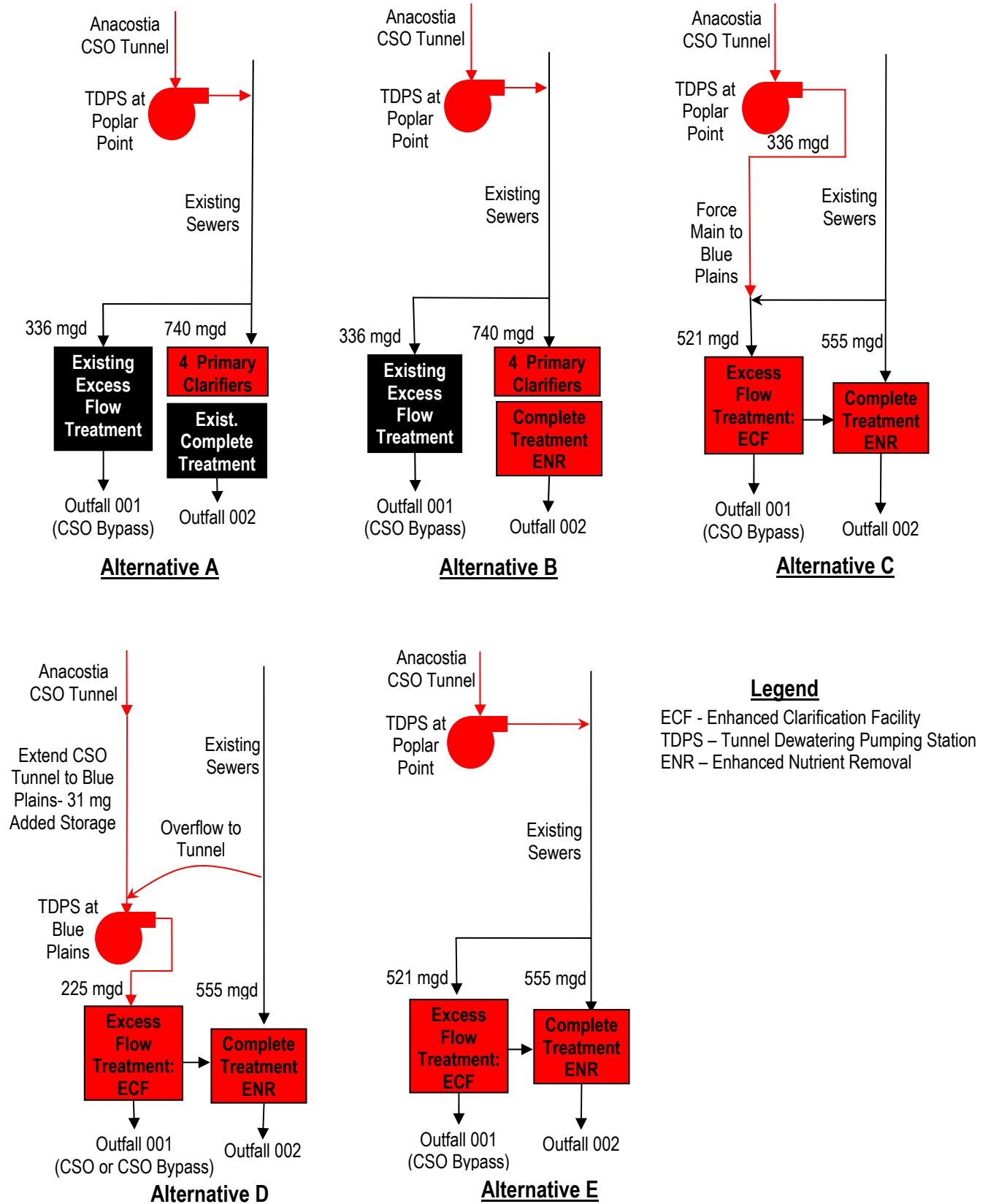

**FIGURE S-4
 ALTERNATIVE PROJECTS**

Summary and Findings

- Alternative D - This alternative is based on maintaining a peak flow rate of 1076 mgd from the collection system to Blue Plains. Peak flow rates to Complete Treatment would be reduced to 555 mgd for the first 4 hours and 511 mgd thereafter. A tunnel would be constructed between Poplar Point and Blue Plains, and flows exceeding the complete treatment capacity would be diverted to the tunnel. The total storage would be 157 mg (126 mg + 31 mg) spread over the Anacostia River tunnels system and the new Blue Plains Tunnel. Flow captured in the tunnels would be dewatered through new headworks at Blue Plains for treatment in a new ECF having a capacity of 225 mgd. Operating provisions would include arrangements to dewater the tunnels during and following wet weather events and to convey ECF effluent to Outfall 001 and/or to Complete Treatment depending on the capacity available in the Complete Treatment facilities. New ENR facilities would be constructed at Blue Plains with capacity to meet the new total nitrogen effluent limit. For this alternative, Outfall 001 could be permitted as a CSO bypass or as a CSO outfall.
- Alternative E – For this alternative, peak flows to complete treatment would be reduced to 555 mgd for the first 4 hours and 511 mgd thereafter. The difference in the maximum rate (1076 mgd) entering the headworks and that to be conveyed to complete treatment (555 mgd) would be 521 mgd. New ECF would be constructed with this capacity (521 mgd) to handle the reduction in peak flow to complete treatment. The facilities to dewater the tunnels system would be located at Poplar Point and would discharge into the existing combined sewers in the area. Operating provisions would include arrangements to dewater the tunnels during and following wet weather events. Flow control provisions would be needed to assure that dewatering the tunnels when other pumping stations are pumping at peak flow rates would not exceed capacities at Blue Plains. Flow treated by the ECF would be discharged from Outfall 001 and/or conveyed to Complete Treatment depending on the capacity available in the Complete Treatment facilities. New ENR facilities would be constructed at Blue Plains with capacity to meet the new total nitrogen effluent limit.

The alternative projects developed for Total Nitrogen Removal/Wet Weather Treatment (TN/WW Plan) have been compared based on the following:

- Capacities of facilities to handle flows and loads conveyed to Blue Plains from the collection system and tunnels.
- Predicted Potomac River water quality in the vicinity of Blue Plains after implementation of a TN/WW Plan.
- Predicted combined sewer overflows to the Anacostia River after implementation of a TN/WW Plan
- Implementation schedule
- Opinions of capital, operating, and maintenance costs
- Qualitative factors such as performance reliability, feasibility of construction considering planned development in the District and other implementation requirements such as modifications to the existing LTCP

Factors used to compare the alternative projects developed for TN/WW plans have been summarized in Table S-2. Detailed comparisons including estimated loads and water quality predictions for pollutant parameters are included in Section 4 of the report.

Summary and Findings

**Table S-2
Comparison of Alternatives**

Parameter	A (Existing LTCP)	Alternatives			
		B	C	D	E
Facility Capacities					
Blue Plains Complete Treatment during wet weather events (mgd)					
1 st 4 hrs	740	740	555	555	555
After 4 hrs	511	511	511	511	511
Excess Flow Treatment (mgd)	336	336	-	-	-
Enhanced Clarification capacity (mgd)	None	None	521	225	521
Anacostia/Blue Plains tunnels storage volume (mg)	126	126	126	157	126
Anacostia/Blue Plains tunnels max dewatering rate (mgd)	170	170	336	225	250
Predicted Average Year Water Quality					
Anacostia River CSO Overflows					
• Number per average year (no./avg yr)	2	2	0 (1)	0 (1)	0 (1)
• Volume per average year (mg/avg yr)	54	54	0 (1)	0 (1)	0 (1)
Blue Plains Outfall 001 + 002 Discharges					
• Overall quality	Per LTCP	Better than LTCP	Much better than LTCP	Much better than LTCP	Much better than LTCP
Fecal Coliform (MPN x 10 ¹⁵ /avg yr)					
• Outfall 001	411	411	2.1	2.0	1.7
• Outfall 002	106	106	105	105	105
Potomac River at Blue Plains					
• Overall quality	Per LTCP	Better than LTCP	Much better than LTCP	Much better than LTCP	Much better than LTCP
• No. days fecal coliform >200 /100 ml/avg yr	9	5	1	1	1
Other Comparative Measures					
Capital Cost Opinion (\$ M, ENR CCI = 7888)	\$ 28	\$ 1,287	\$ 901	\$ 783	\$ 732
Performance Reliability					
• Meet new TN effluent limit	Cannot meet	Has uncertainties	Reliable	Reliable	Reliable
• CSO control	Per LTCP	Flow control complex	Flow control complex	Reliable flow control	Flow control complex
Schedule					
	Not applicable	Longer than C, D, and E	Equal	Equal	Equal

Notes:

- Modeling predicts no overflows in an average year. At the low levels of CSO overflows projected herein, model accuracy is highly dependent on many variables such as the accuracy of rainfall data, information on the drainage area and other factors. As a result, the model predictions mean that CSO overflows in the range of zero to 2 overflows and 54 mg can be expected in an average year. Further, additional overflows will occur for rain events which exceed or are not represented in the average year. The model predictions contained herein do not change the level of CSO control committed to by WASA in its LTCP, which was approved by EPA and the D.C. Department of the Environment.

Summary and Findings

Selected Total Nitrogen Removal/Wet Weather Plan

The comparative features of the various alternative projects have been evaluated to select a TN/WW Plan and the principal comparisons are summarized as follows:

- Alternative A cannot meet the new TN effluent limit and was not considered further.
- Alternatives B and C are not cost effective in terms of capital cost compared to Alternatives D and E. Also, the water quality predicted for Alternative B is not as good as that predicted for Alternatives C, D and E; while the predicted water quality for Alternatives C, D and E is equal. Based on cost effectiveness and predicted water quality performance, Alternatives B and C were not considered further.
- Alternatives D and E appear to be equal in terms of cost effectiveness and predicted water quality. Alternative D includes extension of the tunnels system to Blue Plains and provides greater reliability for CSO control in terms of capture, treatment and expandability.

The comparative evaluations show Alternative D to provide the best features for water quality, performance, reliability, cost effectiveness and capability to meet CSO control requirements. Alternative D is, therefore, recommended for selection as the TN/WW Plan. The principal components of the recommended plan are shown on Figure S-5 and are summarized as follows:

- Blue Plains complete treatment capacity - Blue Plains will provide complete treatment for up to 555 mgd for the first four hours and 511 mgd thereafter. In accordance with the existing NPDES permit, combined sewer system flow (CSSF) conditions (i.e. wet weather events) exist and start when plant influent flow is greater than 511 mgd. CSSF conditions stop four hours after plant influent flow drops below 511 mgd or 4 hours has elapsed since the start of CSSF conditions, whichever occurs last.
- Enhanced nitrogen removal (ENR) – ENR facilities will be constructed with capacity to provide complete treatment for the flow rates identified above and to meet the new total nitrogen effluent limit. ENR technologies to meet the new total nitrogen effluent limit will be evaluated. Technologies that may be evaluated include conventional nitrification/denitrification reactors, moving bed biofilm reactors (MBBRs), biological anoxic flooded filters (BAFs) and integrated fixed film activated sludge (IFAS). The evaluation will include pilot studies of one or more technologies to select the appropriate process and to obtain detailed information on parameters for design.
- Enhanced Clarification Facility (ECF) – a 225 mgd ECF facility will be constructed at Blue Plains. Pilot testing of this treatment technology will be performed to confirm its suitability and parameters for design.
- Tunnel to Blue Plains and System Storage Volume – a new tunnel will be constructed from Poplar Point to Blue Plains. The total tunnels system storage volume will be increased from the 126 mg included in the LTCP to 157 mg. The diameters of the tunnels system and the apportionment of the storage volume among the various tunnel sections will be dependent on facility planning. This new tunnel segment will serve as a flow equalization facility which provides for reducing the capacity of the ECF.

FIGURE S-5

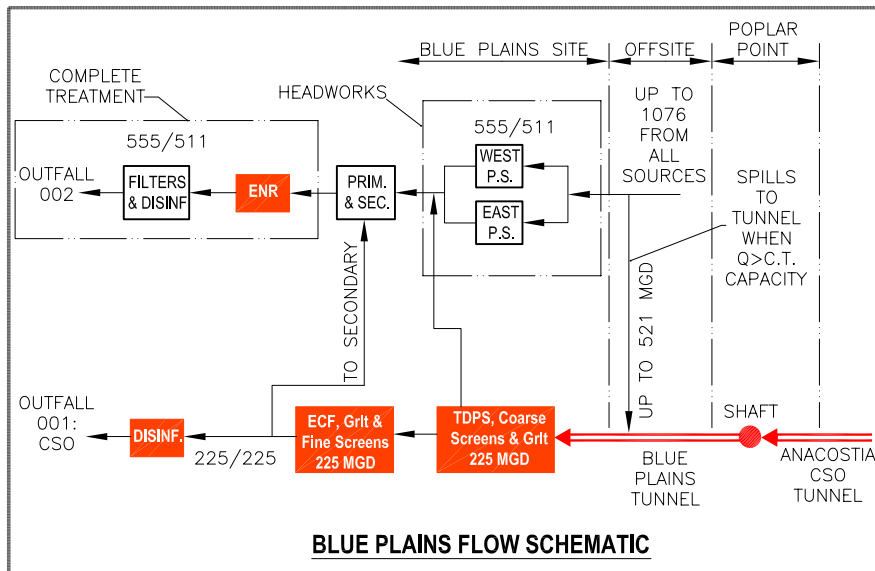
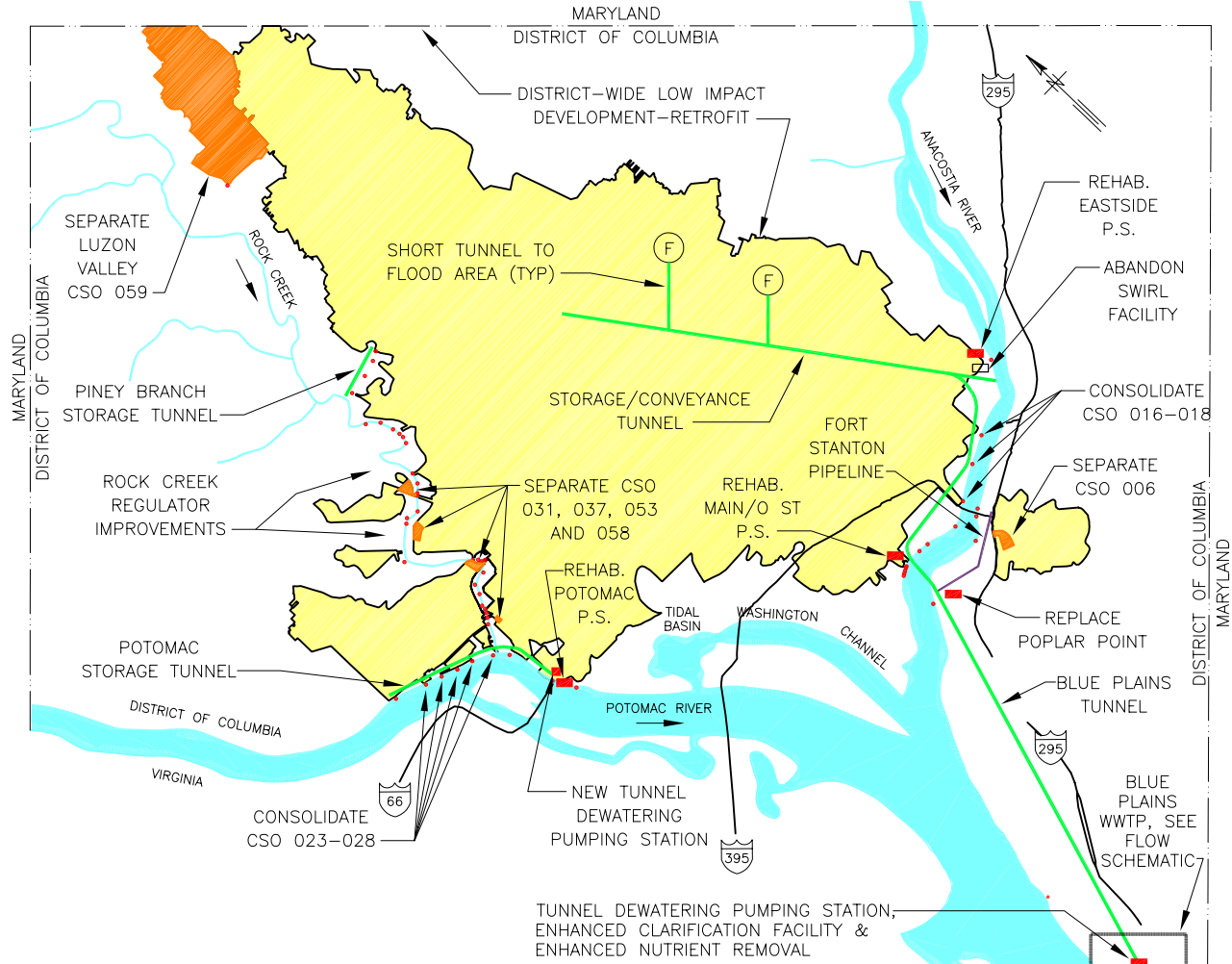

- LEGEND**
- CSO OUTFALL
 - WWTP OUTFALL
 - COMBINED SEWER AREA
 - COMBINED SEWER AREA TO BE SEPARATED
 - NEW PUMPING STATION OR MODIFIED EXIST. PUMPING STATION
 - NEW TUNNEL
 - NEW PIPELINE
 - (F) FLOOD AREA
- TDPS TUNNEL DEWATERING PUMPING STATION
P.S. PUMPING STATION
C.T. COMPLETE TREATMENT
ECF ENHANCED CLARIFICATION FACILITY
ENR ENHANCED NUTRIENT REMOVAL
- BLUE PLAINS FLOW RATES (MGD)
1ST 4 HRS/AFTER 4 HRS

RECOMMENDED PLAN

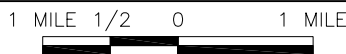

METCALF & EDDY
 GREELEY AND HANSEN LLC
 LIMNO-TECH, INC

D.C. WATER AND SEWER AUTHORITY
 TOTAL NITROGEN/WET WEATHER PLAN

Summary and Findings

- Outfall Sewer Overflow to Blue Plains Tunnel – a connection between the existing outfall sewers on the influent side of Blue Plains and the tunnel to Blue Plains will be constructed. This facility will allow flow from the collection system that exceeds the complete treatment capacity of the plant to overflow to the tunnel.
- Tunnel Dewatering Pumping Station – in the Final LTCP, the tunnel dewatering pumping station was to be constructed at the tunnel terminus at Poplar Point. As part of the TN/WW plan, the tunnel dewatering pumping station at Poplar Point will be deleted and constructed at the new terminus of the tunnel at Blue Plains. The pumping station will be sized to have a minimum firm capacity of 225 mgd, equal to the capacity of the ECF. In addition, the facility will have the ability to dewater the tunnels system to the new ECF and discharge ECF effluent to complete treatment for discharge at Outfall 002 or for discharge at Outfall 001.

Schedule

The schedule for implementing nitrogen control was developed considering constructability and the desire to achieve nitrogen control as early as practicable. It is assumed that the LTCP consent decree will be modified to include the projects required to implement the TN/WW Plan. Based on this evaluation, the schedule identified below has been developed. The schedule is based on receipt of EPA approval of the TN/WW Plan by January 1, 2008. If approval occurs after this date, then revision of the schedule will be required.

- Nitrogen Limit Compliance – place nutrient removal facilities in operation by July 1, 2014, which is 6 years and 6 months after approval of the TN/WW Plan (assumed to occur January 1, 2008). Since nitrogen compliance is judged based on a full calendar year, start compliance with the TN limit the first full calendar year following placing facilities in operation.
- Wet Weather Facilities - place facilities in operation by March 23, 2018, which is 10 years and 3 months after approval of the TN/WW Plan (assumed to occur January 1, 2008). Note that the 2018 date is also the deadline in the LTCP Consent Decree for placing in operation the Anacostia Tunnel and appurtenances from Poplar Point to Northeast Boundary. The wet weather facilities include the Enhanced Clarification Facility, Tunnel to Blue Plains and Tunnel Dewatering Pumping Station.

Outfall 001 Nitrogen Allocation and Permitting Approach

The Blue Plains NPDES permit was modified on April 5, 2007 to include a TN limit for Blue Plains of 4.689 million pounds of nitrogen per year. The permit allocated this entire load to Outfall 002, the complete treatment outfall. For Outfall 001, there were no allocations for nitrogen or any other parameter. The fact sheet accompanying the permit indicated the derivation of the TN limit was as shown on Table S-3. The fact sheet did not explain why an allocation was not assigned to Outfall 001.

Summary and Findings

**Table S-3
EPA's Derivation of TN Limit for Blue Plains
Fact Sheet Accompanying April 5, 2007 NPDES Permit Modification**

Source	TN Load Allocation (mil lbs/yr)
D.C. CSO after LTCP	0.0053
D.C. non-point sources	0.28
D.C. portion of Blue Plains	2.115
Total D.C.	2.4
D.C. portion of Blue Plains	2.115
Maryland part of Blue Plains	1.993
Virginia part of Blue Plains	0.581
Total Blue Plains	4.689

The LTCP demonstrated that Outfall 001 met the requirements of a CSO bypass per the CSO Policy. This was approved along with the entire LTCP and the NPDES permit recognized Outfall 001 as a CSO bypass.

As with other CSOs, flows and pollutant concentrations from Outfall 001 vary dramatically based on the rainfall, the nature of the storm event, antecedent moisture conditions and other factors. Like other CSOs, end of pipe effluent limits are inappropriate for this outfall. This was recognized in the NPDES permit which includes no effluent limits for bacteria, TSS, BOD or other parameters for Outfall 001 or any other CSO. Instead, the LTCP and permit provide that the water quality performance of Outfall 001 and the other CSOs are to be evaluated by post construction monitoring. The evaluation would include monitoring of the discharges and the receiving waters for an extended period of actual operation. The measured discharges from the outfalls and the measured water quality in the receiving waters would be related back to average year conditions using modeling. The predicted performance in the average year would be the basis for determining whether the LTCP (including 001) was performing as predicted and therefore meeting water quality standards or whether additional CSO controls were required. This was the basis for EPA and the D.C. Department of the Environment approval of the LTCP as meeting water quality standards, subject to post construction monitoring. This approval was made based on the predicted performance of Outfall 001, the remaining CSOs and the predicted water quality after implementation of the LTCP.

In addition to the new ECF, implementation of the TN/WW Plan includes a tunnel dewatering pumping station, grit removal and coarse screening facilities to be constructed for Outfall 001. These facilities provide separate headworks for Outfall 001. As a result, Outfall 001 could be permitted either as a CSO bypass or as a CSO outfall. The allocation of nitrogen under each of these approaches is described below:

- Outfall 001 as a CSO Bypass – Under this approach, a nitrogen load would be allocated to Outfall 001 as a CSO bypass. The load would be treated in a fashion similar to CSOs in that there would be no mass or concentration permit limit and the performance would be evaluated based on post-construction monitoring. The load allocated to Outfall 002 would be reduced accordingly to maintain the same total nitrogen load for the District. Table 5-3 shows this load allocation.
- Outfall 001 as a CSO – Under this approach, the nitrogen load allocated to Outfall 001 would be added to the CSO nitrogen load. The load would be treated like all of the other CSOs in that there would be no mass or concentration permit limit and the performance would be evaluated based on post-construction monitoring. The load allocated to Outfall 002 would be

Summary and Findings

reduced to maintain the same total nitrogen load for the District. Table S-4 shows this load allocation.

**Table S-4
Proposed TN Load Allocation – Outfall 001 as a CSO Bypass or CSO**

Source	TN Load Allocation (mil lbs/yr)		
	Fact Sheet Accompanying April 5, 2007 Permit Modification	Outfall 001 as a CSO Bypass	Outfall 001 as a CSO
D.C. CSO after LTCP	0.0053	0.0053	$0.0053 + 0.18 = 0.1853$
D.C. Blue Plains CSO Bypass (001)	-	0.18	-
D.C. non-point sources	0.28	0.28	0.28
D.C. portion of Blue Plains	2.115	$2.115 - 0.18 = 1.935$	$2.115 - 0.18 = 1.935$
Total DC	2.4	2.4	2.4
D.C. portion of Blue Plains	2.115	1.935	1.935
Maryland part of Blue Plains	1.993	1.993	1.993
Virginia part of Blue Plains	0.581	0.581	0.581
Total Blue Plains	4.689	4.509	4.509

Under either approach, the nitrogen load allocated to Outfall 001 would be evaluated based on post construction monitoring and performance with the allocation measured against the average year. This is entirely consistent with the allocations to CSOs made for other parameters under various TMDLs and the fact that nitrogen allocations are to be made TMDLs. Average year TMDL allocations to CSOs include daily and annual allocations for representative climate periods. For TMDLs with climate periods different than that used for the LTCP, the TMDL will be translated to an equivalent TMDL for the LTCP climate period.

Considering the foregoing, it is recommended that Outfall 001 be permitted as a CSO because it will have a separate headworks after implementation of the TN/WW Plan and because this approach best fits and makes clear the performance expectations and evaluations for this outfall.

Implementation Requirements

Implementation of the wet weather plan will require modification to the LTCP consent decree and WASA's NPDES permit.

Modifications to the LTCP consent decree are summarized as follows:

- Adjust the Anacostia River Projects tunnels storage capacities
- Adjust the work included for the Poplar Point Pumping Station
- Delete the Blue Plains Excess Flow improvements, including the four additional primary clarifiers
- Add the new tunnel to Blue Plains
- Add the new ECF and pumping complex at Blue Plains
- Include NPDES permit conditions in the consent decree modification that would become effective when the new ECF complex is placed in operation.
- Other changes needed to make the LTCP consent decree consistent with the TN/WW Plan.

Summary and Findings

The NPDES permit will need to be modified to agree with TN/WW plan. Modifications for the NPDES permit are summarized as follows and are applicable after the Enhanced Clarification facilities have been placed in operation.

- Part 1, Section A – Effluent Limitations and Monitoring Requirements Outfall 001
 - Revise the status of Outfall 001 to reflect it being a separate CSO and the discharge for the new ECF complex
 - Revise the description of the treatment provided to Outfall 001 to include enhanced clarification and disinfection
 - Revise the maximum flow rate to be treated and discharged from Outfall 001 to be 225 mgd
 - Discharge limitations and monitoring remain unchanged

- Part 1, Section B – Effluent Limitations and Monitoring Requirements Outfall 002
 - Dry Weather Flow (DWF) conditions exist when plant influent flows are equal to or less than 511 mgd.
 - Combined Sewer System Flow (CSSF) conditions exist and shall be deemed to start when plant influent flows are greater than a rate of 511 mgd. CSSF conditions shall be deemed to stop 4 hours after plant influent flows drop to a rate less than 511 mgd or a period of 4 hours has elapsed since the start of CSSF conditions, whichever occurs last.
 - Delete Excess Flow Treatment
 - The following flows shall receive complete treatment:
 - For the first four hours, plant influent flows less than or equal to 555 mgd
 - After four hours, plant influent flows up to 511 mgd
 - When DWF conditions exist, no flow may be discharged from Outfall 001.
 - When CSSF conditions exist, plant influent flows greater than the 555 mgd or 511 mgd rates required to receive Complete Treatment; shall receive Excess Flow Treatment and a maximum rate of 225 mgd may be discharged from Outfall 001

- Part III, Section D – Post Construction Monitoring
 - At subsection 4, add a provision for translating TMDLs and other allocations developed for climate periods different than that used for the LTCP, to be translated to an equivalent TMDL or allocation for the LTCP climate period.

- Clarify the nitrogen allocation in Part 1 Section B and in Part IV Section E to indicate that the permit load applies to Outfall 002 only.

- Other changes needed to make the NPDES Permit consistent with the TN/WW Plan.

Section 1 Introduction

1.1 PURPOSE

The District of Columbia Water and Sewer Authority (WASA or Authority) provides wastewater collection and treatment for the District of Columbia, and wastewater treatment for surrounding areas including parts of suburban Virginia and Maryland at the District's Advanced Wastewater Treatment Plant at Blue Plains (Blue Plains). On April 5, 2007, the United States Environmental Protection Agency (EPA) issued a modification to WASA's National Pollutant Discharge Elimination System (NPDES) permit. The permit modification includes a total nitrogen effluent limit for Blue Plains of 4.689 million pounds per year. The total nitrogen limit was developed by EPA to achieve the goals of the Chesapeake Bay Program for nutrient reductions.

In addition to meeting the new effluent limit for total nitrogen, WASA has existing NPDES Permit requirements for treating wet weather flows at Blue Plains. The latter requirement is part of WASA's Long Term Control Plan (LTCP) for the combined sewer system. The purpose of this report is to present WASA's approach to meet the new total nitrogen effluent limit and to comply with its existing permit conditions to treat wet weather flows.

1.2 BACKGROUND

1.2.1 Blue Plains Advanced Wastewater Treatment Plant

WASA operates Blue Plains, which provides treatment to combined sewer and sanitary flows from the District of Columbia and sanitary flows from Fairfax County and Loudoun County in Northern Virginia, and Montgomery County and Prince Georges County in Maryland. The jurisdictions outside Washington, D.C. have sanitary sewers that discharge flow into WASA's wastewater interceptor system through which the flows are conveyed to Blue Plains. The total population served by Blue Plains exceeds two million.

History of the Development of Blue Plains

The initial wastewater treatment plant at Blue Plains consisted of a 130 mgd primary treatment facility. The treatment plant has been expanded and upgraded many times since the initial operation in 1938. Secondary treatment was placed in operation in the 1960s. A major program to expand and upgrade Blue Plains to advanced treatment was carried out in the 1970s and early 1980s. The sizing of this facility was based on an average daily flow of 309 mgd, with a peak flow to secondary treatment of 650 mgd, and a peak plant wet weather flow of 939 mgd. This design was based on a 3-stage biological process, with separate reactor and clarifier facilities for secondary, nitrification and denitrification. The denitrification process was designed but not constructed.

Based upon the desire of the Blue Plains Users for increased capacity, a feasibility study was conducted in the 1980's to determine whether it was more cost effective to expand Blue Plains within the existing site constraints or build new/expand other existing plants for the Blue Plains service area. The study concluded that, with modest new facilities, Blue Plains could be expanded and re-rated to an average daily flow of 370 mgd, peak flow to secondary of 740 mgd, and a peak plant influent flow of 1,076 mgd.

The major changes that were made to re-rate the plant to an average annual capacity of 370 mgd were:

- Secondary process – channel modifications and new sluice gates to allow the plant to use the step feed process for control of settling during wet weather flows
- Nitrification – channel modifications and new sluice gates to allow the plant to use the step feed process for control of settling during wet weather flows

Introduction

- Dual Purpose Sedimentation Basins – 8 new basins were constructed to augment both the secondary and nitrification sedimentation basins
- Filtration Facilities – 2 new filter influent pumps and 4 new filters were constructed

The primary treatment process was not expanded or modified to meet the new 370 mgd flow conditions. The re-rating to 370 mgd was with the requirement for nitrification only.

Nutrient Removal

During the 1990's, the need to reduce nitrogen loading to the Chesapeake Bay became more urgent. WASA evaluated several options and concluded that utilizing a portion of the nitrification reactors for biological nutrient removal (BNR) was most cost-effective to meet the goals of the Chesapeake Bay Program to reduce nutrients by 40% from 1985 levels. The last 2 of the 5 stages in each nitrification reactor were converted to anoxic stages and systems to add methanol ahead of Stage 4 provided the conditions required for BNR. These modifications were constructed in 1998 under the Denitrification Demonstration Facility Contract to evaluate half-plant-scale nitrogen removal. This process was successfully operated for 2 years and led to construction of full plant denitrification for Blue Plains. Construction of full-scale facilities was completed in early 2000 and WASA has since successfully operated the BNR process to meet an annual average goal of 7.5 mg/l of total nitrogen in the effluent discharge.

Current Process Configuration

The plant liquid treatment processes consist of pumping, preliminary treatment (screening and grit removal), primary treatment, secondary treatment, nitrification, denitrification, effluent filtration, and chlorination/dechlorination. Chemical phosphorous removal is provided in the primary and secondary treatment processes. Biosolids handling processes include screening, degritting, and gravity thickening of primary sludge, dissolved air flotation thickening of biological sludge, sludge blending, dewatering, and biosolids cake post liming, storage and loading.

A Blue Plains Service Area Facility Planning Study was completed in December 2003 by the Metropolitan Washington Council of Governments on behalf of the Blue Plains Technical and Regional Committees. The conclusion of that study was that the 370 mgd rated capacity of Blue Plains will be sufficient to provide for the wastewater treatment needs of the service area until the year 2030. Figure 1-1 shows that the Blue Plains site is constrained by the Naval Research Laboratory, Interstate 295 and the Potomac River.

1.2.2 Wastewater Collection System

The suburban sewer systems in the Blue Plains service area consist of separate sanitary and storm sewers. In the District, the sewer system is comprised of both combined sewers and separate sanitary sewers. A combined sewer carries both sewage and runoff from storms. Modern practice is to build separate sewers for sewage and storm water, and no new combined sewers have been built in the District since the early 1900's. Approximately one-third of the District (12,478 acres) is served by combined sewers. The majority of the area served by combined sewers is in the older developed sections of the District.

In the combined sewer system, sewage from homes and businesses during dry weather conditions is conveyed to the Blue Plains, which is located in the southwestern part of the District on the east bank of the Potomac River. There, the wastewater is treated to remove pollutants before being discharged to the Potomac River. When the capacity of a combined sewer is exceeded during storms, the excess flow, which is a mixture of sewage and storm water runoff, is discharged to the Anacostia and Potomac Rivers, Rock Creek and tributary waters. The excess flow is called Combined Sewer Overflow (CSO). There are a total of 53 CSO outfalls in the combined sewer system listed in the NPDES Permit issued by the EPA to WASA.

FIGURE 1-1

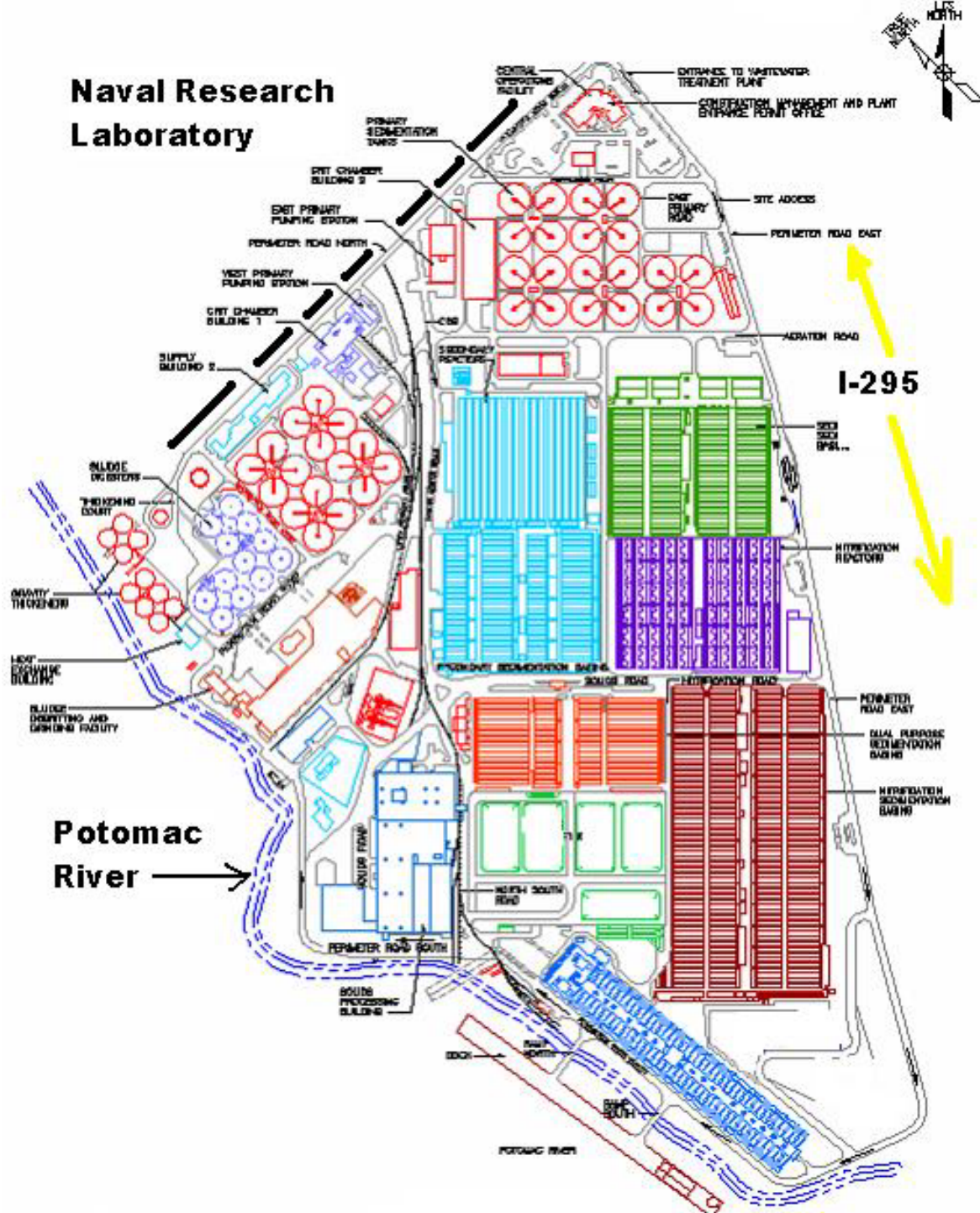

BLUE PLAINS SITE PLAN

Introduction

1.2.3 Long Term Control Plan

In accordance with the 1994 CSO Policy, WASA submitted a draft plan for controlling CSOs (called a Long Term Control Plan, or LTCP) to EPA in 2001. After an extensive public participation program which generated over 2,300 comments on the Draft LTCP, WASA submitted a Final LTCP to EPA in 2002. The major elements of the Final LTCP are summarized in Table 1-1 and are shown on Figure 1-2.

**Table 1-1
Final LTCP Components**

Component	Description
<i>System Wide</i>	
Low Impact Development – Retrofit (LID-R)	Advocate implementation of LID-R throughout entire District. Provide technical and regulatory assistance to District Government. Implement LID-R projects on WASA facilities where feasible.
<i>Anacostia River</i>	
Rehabilitate Pumping Stations	Rehabilitate existing pumping stations as follows: <ul style="list-style-type: none"> • Interim improvements at Main and ‘O’ Street Pumping Stations necessary for reliable operation until rehabilitation of stations is performed. • Rehabilitate Main Pumping Station to 240 mgd firm sanitary capacity. Screening facilities for firm sanitary pumping capacity only. • Rehabilitate Eastside and ‘O’ Street Pumping stations to 45 mgd firm sanitary capacity Interim improvements at existing Poplar Point Pumping Station necessary for reliable operation until replacement pumping station is constructed as part of storage tunnel
Storage Tunnel from Poplar Point to Northeast Boundary Outfall	49 million gallon storage tunnel between Poplar Point and Northeast Boundary. Tunnel will intercept CSOs 009 through 019 on the west side of the Anacostia. Project includes new tunnel dewatering pump station and low lift pumping station at Poplar Point.
Storage/Conveyance Tunnel Parallel to Northeast Boundary Sewer	77 million gallon storage/conveyance tunnel parallel to the Northeast Boundary Sewer. Also includes side tunnels from main tunnel along West Virginia and Mt. Olivet Avenues, NE and Rhode Island and 4 th St NE to relieve flooding. Abandon Northeast Boundary Swirl Facility upon completion of main tunnel.
Outfall Consolidation	Consolidate the following CSOs in the Anacostia Marina area: CSO 016, 017 and 018
Separate CSO 006	Separate this CSO in the Fort Stanton Drainage Area
Ft Stanton Interceptor	Pipeline from Fort Stanton to Poplar Point to convey CSO 005, 006 and 007 on the east side of the Anacostia to the storage tunnel.
<i>Rock Creek</i>	
Separate Luzon Valley Separation	Separation was completed in 2002
Monitoring at CSO 033, 036, 047 and 057	Conduct monitoring to confirm prediction of overflows. If overflows confirmed, then perform the following: <ul style="list-style-type: none"> • <u>Regulator Improvements</u>: Improve regulators for CSO 033, 036, 047 and 057 • <u>Connection to Potomac Storage Tunnel</u>: Relieve Rock Creek Main Interceptor to proposed Potomac Storage Tunnel when it is constructed
Storage Tunnel for Piney Branch (CSO 049)	9.5 million gallon storage tunnel
<i>Potomac River</i>	
Rehabilitate Potomac Pumping Station	Rehabilitate station to firm 460 mgd pumping capacity
Outfall Consolidation	Consolidate CSOs 023 through 028 in the Georgetown Waterfront Area.
Potomac Storage Tunnel	58 million gallon storage tunnel from Georgetown to Potomac Pumping Station. Includes tunnel dewatering pumping station.
<i>Blue Plains Wastewater Treatment Plant</i>	
Excess Flow Treatment Improvements	Four new primary clarifiers, improvements to excess flow treatment control and operations

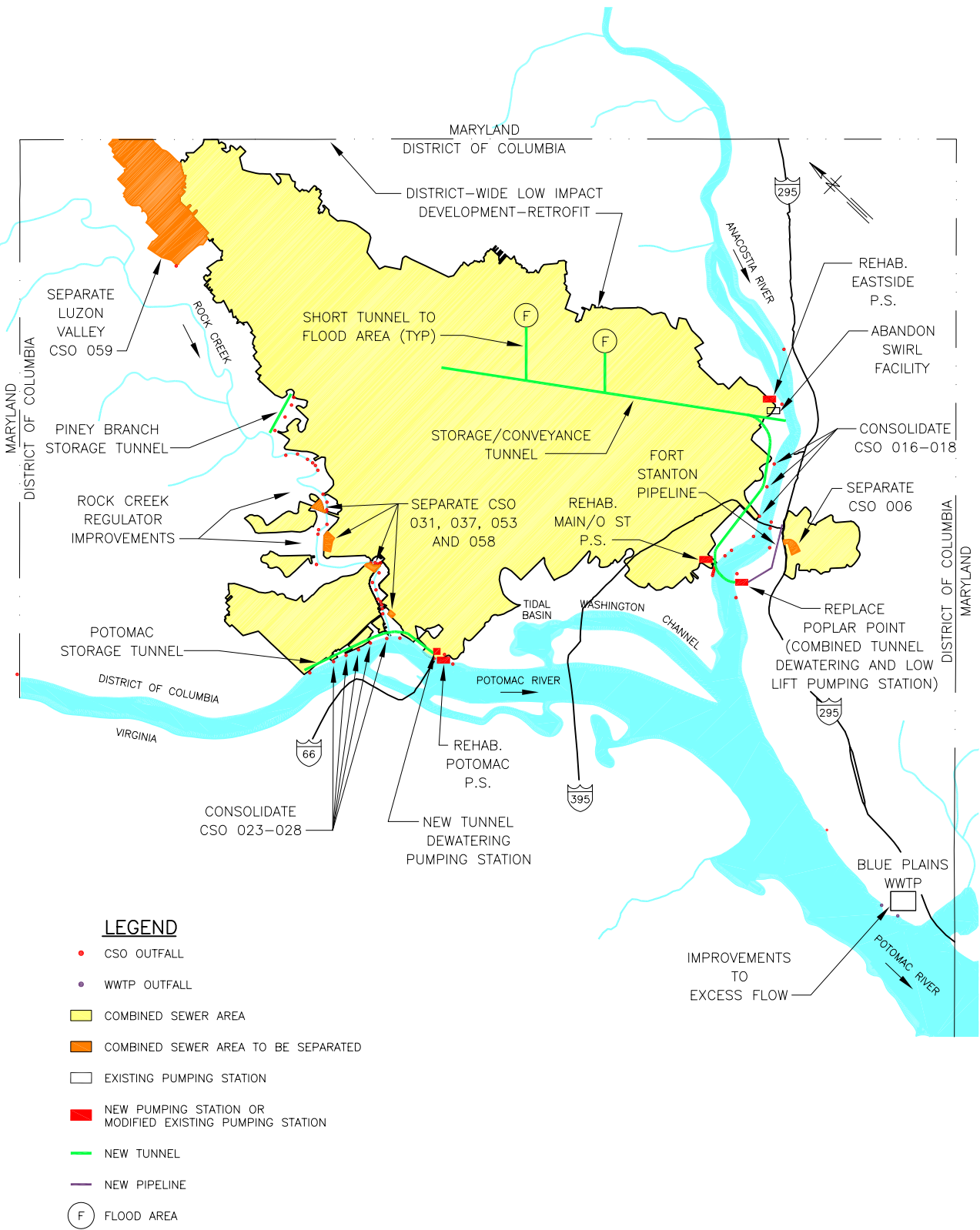

LONG TERM CONTROL PLAN

1 MILE 1/2 0 1 MILE



Introduction

Table 1-2 shows the predicted performance after the LTCP is implemented.

**Table 1-2
CSO Overflow Reduction of Final LTCP (Average Year)**

<i>Item</i>	<i>Anacostia River</i>	<i>Potomac River</i>	<i>Rock Creek</i>	<i>Total System</i>	<i>% Capture of Combined Sewage per CSO Policy</i>
CSO Overflow Volume (mg/yr)					
Before CSO Control Program ¹	2,142	1,063	49	3,254	76%
After Implementation of LTCP	54	79	5	138	99%
% Reduction	97.5%	92.5%	89.8%	95.8%	-
Number of Overflows/yr					
Before CSO Control Program ¹	82	74	30	-	-
After Implementation of LTCP	2	4	1 / 4 ²	-	-

Notes:

1. System as it existed in 1998, prior to replacement of the inflatable dams and prior to rehabilitation of pumping stations
2. One at Piney Branch, four at the other Rock Creek CSOs.

The D.C. Department of the Environment (formerly Department of Health) and EPA approved the Final LTCP. In addition, they determined that CSOs remaining after implementation of the plan would not cause or contribute to exceedances of water quality standards, subject to post construction monitoring. Regulatory agencies also determined that the CSOs remaining after implementation of the plan would comply with total maximum daily loads (TMDLs) established for the receiving waters.

WASA is currently implementing the LTCP in accordance with a Consent Decree entered with the District court in 2005, as described below.

1.3 REGULATORY REQUIRMENTS

1.3.1 Chesapeake Bay Program

The Chesapeake Bay, located between southern Maryland and Virginia, is the largest estuary in the United States. The Bay watershed is about 64,000 square miles and includes all of the District of Columbia, and parts of Delaware, Maryland, New York, Pennsylvania, Virginia, and West Virginia.

As a result of research on water quality impairments in the Bay in the 1970s, the 1983 Chesapeake Bay Agreement was signed by the District, Maryland, Virginia, Pennsylvania and EPA. As part of the agreement, the parties agreed to coordinate efforts to improve the Bay and formed the Chesapeake Bay Program to guide this effort. The 1987 Chesapeake Bay Program Agreement set a goal of 40% reduction in nutrients by 2000 from 1985 levels. In the 1992 Amendments to the Chesapeake Bay Program Agreements, the parties agreed to set tributary strategies to achieve nutrient reductions.

In the Chesapeake Bay 2000 Agreement, EPA developed water quality criteria for the Bay and its tributaries in order to achieve water quality conditions protective of the aquatic resources of the Bay. Further, the states agreed to revise their water quality standards to match EPA's Bay criteria and to use the tributary strategies to establish cap loadings for drainage basins in the watershed.

The District, Maryland and Virginia have recently revised their water quality standards and have developed tributary strategies which cap loadings for nutrients and other pollutants. Since Blue Plains receives flow from Maryland, Virginia and the District, EPA has calculated the allowable total nitrogen load for Blue Plains based on the Maryland and Virginia load allocations for the plant and based on loads allocated to the District. These load allocations are described in the following section.

1.3.2 NPDES Permit

EPA has issued WASA Permit No. DC0021199 authorizing discharges from Blue Plains and the combined sewer system in accordance with the permit conditions. The permit has an effective date of February 25, 2003 and an expiration date of February 25, 2008. There are two portions of the permit which have significant bearing on the TN/WW Plan as follows:

- Nitrogen limits
- Flow limits

Each is described below:

Nitrogen limits

There is no nitrogen limit in the current permit. Instead, the permit has a total nitrogen goal of 8,467,200 lbs/year of TN, which is equivalent to approximately 7.5 mg/L TN at an annual average flow rate of 370 mgd. WASA is required to undertake best efforts to meet this goal to the extent such operation does not preclude meeting other obligations in the permit.

On August 18, 2006, EPA public noticed a permit modification which included the following:

- An interim effluent limit for TN of 8,600,000 lbs/year of TN, equivalent to approximately 7.6 mg/L TN at 370 mgd
- An interim TN goal of 5,800,000 lbs/year of TN, equivalent to approximately 5.1 mg/L TN at 370 mgd
- A schedule for submitting a plan to reduce nitrogen to achieve the final Chesapeake Bay Program goal for Blue Plains of 4,689,000 pounds per year.

On December 14, 2006, EPA public noticed a permit modification which withdrew the nitrogen requirements identified in the August 18, 2006 proposed permit modification. The December 14, 2006 proposed permit modification added a TN limit of 4,689,000 pounds per year, equivalent to 4.2 mg/L at 370 mgd. On April 5, 2007, this permit modification was issued and the effective date of the permit was indicated to be June 4, 2007. The Fact Sheet accompanying the permit identified the basis for the nitrogen limit as shown in Table 1-3.

**Table 1-3
EPA's Bases for TN Limit at Blue Plains**

Load Source	TN Load (lbs/year)
D.C. Nitrogen Allocation	+2,400,000
Minus D.C. non-point source (storm water) load	-280,000
Minus D.C. CSO load after implementation of LTCP	-5,300
Subtotal = D.C. portion of Blue Plains allocation	2,115,000
Plus Maryland portion of Blue Plains load	+1,993,000
Plus Virginia portion of Blue Plains load	+581,000
Total allocated load	4,689,000

Introduction

Flow limits

The permit defines the following treatment types and flow conditions at the plant:

- Initial Treatment – means providing plant influent flows with screening, grit removal and primary treatment
- Excess Flow Treatment – means providing Initial Treatment followed by treatment in the east primary treatment facilities, then followed by chlorination and dechlorination with discharge from Outfall 001.
- Complete Treatment – means passage of plant influent and recycle flows through any combination of conveyance and treatment facilities downstream of primary sedimentation that ultimately discharges at effluent 002.
- Dry Weather Flow (DWF) conditions – these conditions exist when plant influent flows are equal to or below 511 mgd.
- Combined Sewer System Flow (CSSF) conditions – these conditions exist and start when plant influent flow is greater than 511 mgd. CSSF conditions stop four hours after plant influent flow drops below 511 mgd or 4 hours has elapsed since the start of CSSF conditions, whichever occurs last.

The facility is rated for an annual average flow of 370 mgd. During wet weather events, flows up to 740 mgd receive complete treatment for up to 4 hours. After the first 4 hours, the complete treatment capacity is reduced to 511 mgd to protect the biological process. Additional flows of up to 336 mgd that exceed the complete treatment capacity of the plant receive excess flow treatment, which consists of screening, grit removal, primary treatment and disinfection before discharge to the Potomac River.

Currently, rehabilitations and improvements to the plant are underway in a capital improvement program for the liquid processes. During the construction for this program, the permit provides for reduced flow limits. Complete treatment capacity is 511 mgd for up to 4 hours. After the first 4 hours, the complete treatment capacity is reduced to 450 mgd. Excess flow treatment remains at up to 336 mgd. Table 1-4 summarizes the plant flow limits included in the permit.

**Table 1-4
NPDES Permitted Flow Limits**

Condition	Maximum Flow Limit (mgd)	
	No Liquid Phase Construction Program	During Liquid Phase Construction Program
Complete Treatment - 1 st 4 hours	740	511
Complete Treatment - after 4 hours	511	450
Excess Flow Treatment	336	336
Max Total Plant Influent Rate – 1 st 4 hours	1,076	847
Max Total Plant Influent Rate – after 4 hours	847	786

1.3.3 Consent Decrees

WASA has entered into two consent decrees (CD) related to its CSO program. Each of these decrees is described below:

Three-Party Consent Decree - Civil Action No. 1:00CV00183TFH and No. 02-2511 (TFH)

WASA and the District of Columbia entered into this CD with the United States Government and certain citizen plaintiffs to resolve allegations regarding the combined sewer system (CSS). The CD was lodged

with and entered by the court on June 25, 2003 and October 10, 2003, respectively. The CD provides a schedule for implementation of various operation and maintenance-type items associated with WASA's Nine Minimum Controls Program. In addition, the CD provides a schedule for replacement of the inflatable dams in the CSS and for rehabilitation of WASA's pumping stations.

Further, the CD requires that WASA ensure that, after September 1, 2008, the collection system has the capacity to convey flows at a rate totaling at least 1076 mgd from the areas served by the collection system to the Blue Plains. The CD indicates the September 1, 2008 deadline shall be extended if the following three conditions are met:

- That deficiencies unknown to WASA at the time of the consent decree would preclude compliance with the 1076 mgd capacity conveyance;
- That WASA demonstrates that a date later than September 1, 2008, represents the earliest practicable date by which such deficiencies can be corrected;
- That WASA commits to take all action necessary to comply with 1076 mgd capacity conveyance assurance by such later date.

If an extension of the September 1, 2008 deadline is required, the decree requires that notification be made by October 10, 2006.

WASA conducted physical inspections of the major sewers between the pumping stations and Blue Plains (called the Outfall Sewers) and performed flow monitoring and modeling to assess the systems' conveyance capacity. The physical inspections identified significant portions of the Outfall Sewers with rebar missing, loss of concrete in the crown and other indications of corrosion. In addition, the monitoring and modeling indicated that improvements would need to be made to the Outfall Sewers in order to convey 1076 mgd. WASA submitted a report to EPA (Technical Memorandum No. 15: Outfall Sewer Assessment) on October 6, 2006. The memorandum indicated that 1076 mgd could not be conveyed by September 1, 2008 and indicated that rehabilitation of the outfall sewers was required. WASA and EPA have since agreed to extend the September 1, 2008 deadline to April 11, 2011.

Since facilities need to be taken out of service to perform the rehabilitation of the outfalls sewers, WASA indicated that the maximum flow rate available during the work would be 847 mgd, which is consistent with the treatment capacity available during the concurrent rehabilitations underway at Blue Plains.

Long Term Control Plan Consent Decree - Civil Action No. 1:CV00183TFH

WASA and the District of Columbia entered into this CD with the United States Government. The CD was entered by the court on March 23, 2005, and provides a schedule for implementation of the LTCP. There are many deadlines in the CD related to the various components of the LTCP. Table 1-5 summarizes requirements related to the Anacostia Tunnel and Blue Plains Excess Flow Improvements. Important points related to these requirements are as follows:

- The Anacostia Facility Plan is a plan to provide further definition for the Anacostia Tunnel which WASA developed to a conceptual level in the LTCP. The plan has been started and must be submitted to EPA by September 23, 2008.
- The first leg of the Anacostia Tunnel is from Poplar Point to Northeast Boundary. This portion of the tunnel must be placed in operation by 2018. Designs for components of this tunnel must be started between 2009 and 2013.
- The second leg of the Anacostia Tunnel is parallel to the Northeast Boundary Sewer. This portion of the tunnel must be placed in operation by 2025, with designs starting between 2015 and 2019.

Introduction

- The LTCP included constructing four primary clarifiers at Blue Plains and making improvement to excess flow facilities. The decree requires this to be placed in operation by 2016 with design starting in 2009.

**Table 1-5
Excerpt of LTCP Decree Deadlines**

No.	CD Reference	Requirement	Deadline in CD	Calendar Deadline per CD
Anacostia Projects				
1	p.11, VI.A.9.	Anacostia Facility Plan		
		Start Anacostia Facility Plan	6 months from entry	23-Sep-2005
		Submit summary report & detailed implementation schedule	3 yrs 6 mos from entry	23-Sep-2008
2	p.12, VI.A.12.	Fort Stanton Interceptor		
		Award contract for detailed design	8 years from entry	23-Mar-2013
		Award contract for construction	11 years from entry	23-Mar-2016
		Place in operation	13 years from entry	23-Mar-2018
3	p.13, VI.A.13.	Tunnel From Poplar Point to Northeast Boundary		
		Award contract for detailed design	4 years from entry	23-Mar-2009
		Award contract for construction	7 years from entry	23-Mar-2012
		Place in operation	13 years from entry	23-Mar-2018
4	p.13, VI.A.14.	Poplar Point Pumping Station		
		Award contract for detailed design	7 years from entry	23-Mar-2012
		Award contract for construction	10 years from entry	23-Mar-2015
		Place in operation	13 years from entry	23-Mar-2018
5	p.14, VI.A.15.	Tunnel Parallel to Northeast Boundary Sewer		
		Award contract for detailed design	10 years from entry	23-Mar-2015
		Award contract for construction	13 years from entry	23-Mar-2018
		Place in operation	20 years from entry	23-Mar-2025
6	p.15, VI.A.16.	NEB Side Tunnels		
		Award contract for detailed design	14 years from entry	23-Mar-2019
		Award contract for construction	17 years from entry	23-Mar-2022
		Place in operation	20 years from entry	23-Mar-2025
7	p.15, VI.A.17.	Anacostia Outfall Consolidation		
		Award contract for detailed design	8 years from entry	23-Mar-2013
		Award contract for construction	11 years from entry	23-Mar-2016
		Place in operation	13 years from entry	23-Mar-2018
Blue Plains Projects				
8	p.21. VI.D.29.	Blue Plains Excess Flow Improvements		
		Award contract for detailed design	4 years from entry	23-Mar-2009
		Award contract for construction	7 years from entry	23-Mar-2012
		Place in operation	11 years from entry	23-Mar-2016

1.3.4 TOTAL MAXIMUM DAILY LOADS (TMDLs)

TMDLs for several parameters have been issued for the receiving waters in the District. Table 1-6 summarizes TMDLs issued for waters receiving CSO discharges in the District.

**Table 1-6
TMDLs Issued for District Waters Receiving CSO Discharges**

<i>Anacostia River</i>	<i>Potomac River</i>	<i>Rock Creek</i>
Fecal coliform bacteria	Fecal coliform bacteria	Fecal coliform bacteria
Organics and metals	Organics and metals	Metals
Oil and grease		
Biochemical oxygen demand		
Total suspended solids		

The TMDLs in the District are expressed as annual loads or loads per growing season. In addition, the TMDLs are based on the climatic periods 1988, 1989 and 1990, the same period used to develop the LTCP. Subject to post construction monitoring, the Final LTCP has been determined to meet all of the TMDLs issued.

In a recent decision by the U.S. Court of Appeals for the D.C. Circuit (*Friends of the Earth, Inc. v. EPA, et. al.*, No. 05-5015, D.C. Circuit 2006), the Court held that the total suspended solids and biochemical oxygen demand TMDLs for the Anacostia River did not comply with the Clean Water Act because they were not expressed as daily loads. EPA is in the process of revising these TMDLS to address the court decision. On April 6, 2007, a revised TMDL for total suspended solids was noticed in draft form for public comments. WASA is in the process of reviewing this TMDL. Depending on how these TMDLs are revised, the LTCP will need to be evaluated to determine whether or not the CSO controls can comply with the new TMDLs.

1.4 TN/WET WEATHER PLAN GOALS

The primary goals of the TN /wet weather plan are as follows:

- Upgrade Blue Plains to reliably meet the proposed TN discharge limit
- Provide a system which produces water quality equal to or better than that predicted for the LTCP
- Meet regulatory requirements in a manner that is economically feasible so as not to impose an undue burden on rate payers

Blue Plains Process Evaluation

Section 2 Blue Plains Process Evaluation

2.1 INTRODUCTION

Blue Plains receives combined sewer flows that originate in the District's combined sewer system. The plant is rated to treat an average annual flow rate of 370 million gallons per day (mgd). Flows increase significantly during wet weather; the trigger to define a high flow event is when the plant influent flow rate exceeds 511 mgd. For the first four hours of a high flow event, peak flows at rates up to twice the average annual rated capacity are treated through complete treatment and are discharged to the Potomac River via Outfall 002. For the first four hours, plant influent flows greater than twice the average annual flow up to 1,076 mgd are considered "excess flow". Excess flow receives primary treatment and disinfection and is discharged to the Potomac River via Outfall 001. Figure 2-1 shows the process flow diagram for the existing facilities at Blue Plains during wet weather events.

As described in Section 1, WASA is required to improve nutrient removal performance and treat sustained high flows during wet weather. Increasing nitrogen removal could be achieved by increasing the biomass in the biological reactors. However, additional biomass in the biological reactors coupled with high sustained flows reduces the stability of the nitrogen removal system. Therefore, WASA approached these challenges with a comprehensive planning approach to determine the best way to achieve both requirements simultaneously. This section of the report describes the design conditions for planning purposes, provides an assessment of the facilities and an evaluation of each treatment process, and identifies alternative improvements and strategies at Blue Plains that would increase nitrogen removal and treat the required storm flows.

2.2 BASIS OF DESIGN

Important components that affect the effluent quality from any wastewater treatment system include the characteristics of influent flow and the performance of the treatment system. Several treatment processes at Blue Plains are physical, or physical-chemical, processes. As such, the critical design parameter is peak flow rate because the performance declines as the hydraulic loading rate increases. At Blue Plains, the peak flow rate through preliminary, primary and excess flow treatment is 1,076 mgd and the peak flow rate through the filtration and final disinfection system is 740 mgd.

On the other hand, the secondary and nitrification/denitrification treatment systems are biological processes, whose performance is related to the mass of specific microorganisms in addition to the hydraulic loading rate and influent characteristics. The bacteria that consume organic matter in the secondary process are distinct from the nitrifying and denitrifying bacteria in the nitrogen removal system. The design and operation of a suspended growth activated sludge system requires a balance between increasing the biomass in the reactor and limiting the solids loading rate on the sedimentation basins. The hydraulic loading rate on the sedimentation basins must be limited to prevent wash out of the microorganisms in wet weather. The target mixed liquor suspended solids concentration for both biological systems at Blue Plains is 2,000 mg/l.

The following subsections describe the variations in Blue Plains' influent due to hydrologic and climatic conditions. To meet the annual load cap, the system must perform well each month under the least favorable conditions. Therefore, the maximum monthly influent flows and loads were used in conjunction with the lowest monthly average temperature (12°C). The influent characteristics were determined from historical data. Biological processes work slower (i.e., they are less effective) at low temperatures.

Figure 2-1

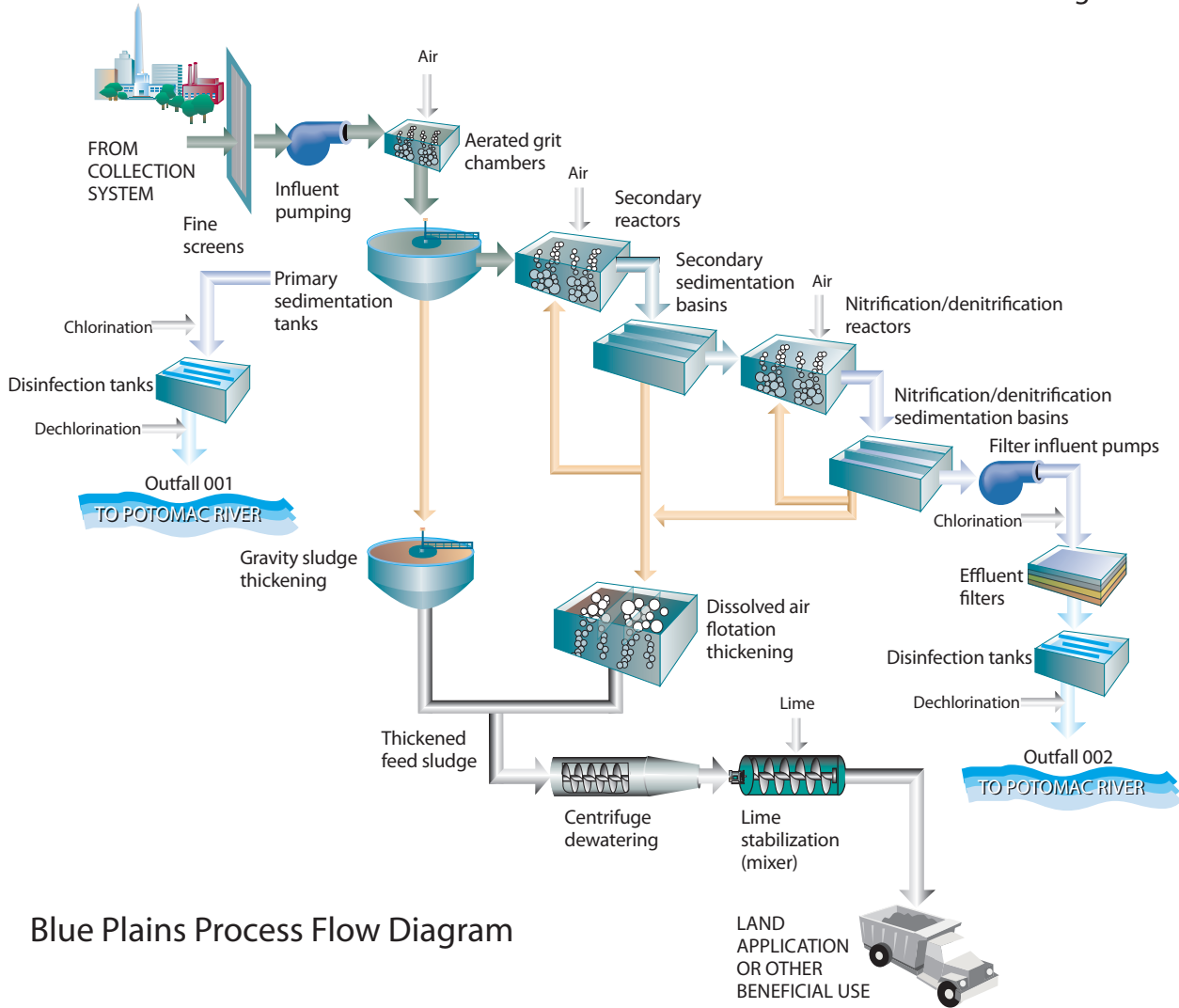

Blue Plains Process Flow Diagram

Blue Plains Process Evaluation

2.2.1 Average Annual Plant Influent Flows

Blue Plains is rated to treat 370 million gallons per day (mgd) on an annual average basis and this capacity has been allocated to the Blue Plains users. Under average hydrologic conditions, projected plant influent is expected to reach 370 mgd, i.e., the rated capacity of Blue Plains, in the year 2030. Table 2-1 presents the contribution of the planned average annual plant influent flow by jurisdiction. The next section of this memorandum provides detail about plant influent flows during wet weather.

**Table 2-1
Projected Average Annual Flow to Blue Plains**

Jurisdiction	IMA Allocation (mgd)	Regional Flow Forecast Model for 2030 ¹ (mgd)
District of Columbia	152.5	171.7
Washington Suburban Sanitary Commission	169.6	150.0
Fairfax County	31.0	31.0
Loudoun County	13.8	13.8
Other Potomac Interceptor Users ²	3.1	3.5
Total	370.0	370.0

¹Blue Plains Service Area Phase I-Facility Planning Study (MWCOG, 2003)

²Other Potomac Interceptor Users are Dulles Airport, the Navy, the Town of Vienna, and the National Park Service

2.2.2 Maximum Month Plant Influent Flows

The average annual rated capacity includes variation in hourly flows due to diurnal fluctuations, variation in seasonal flows due to groundwater table fluctuations, and increases in influent flow due to storm inflow into the collection system. Therefore, it is important to predict plant influent flows during wet weather as well as average annual conditions. Plant influent flow data for recent years was evaluated to predict wet weather plant influent for the future, when Blue Plains reaches its rated capacity.

Actual hourly plant influent flow data for “dry” days during the years 2002 and 2003 were evaluated to assess diurnal influent flow patterns. Dry days were identified by the lowest flow days based on average daily flows. Figure 2-2 shows the average daily plant influent flow for each day from January 1, 2002 through December 31, 2003. The band shown between 275 mgd and 310 mgd includes the “dry” days. During the days in which the flow is above 310 mgd, there are significant inputs to the wastewater flow from storm flow, infiltration, or both.

Blue Plains Process Evaluation

FIGURE 2-2

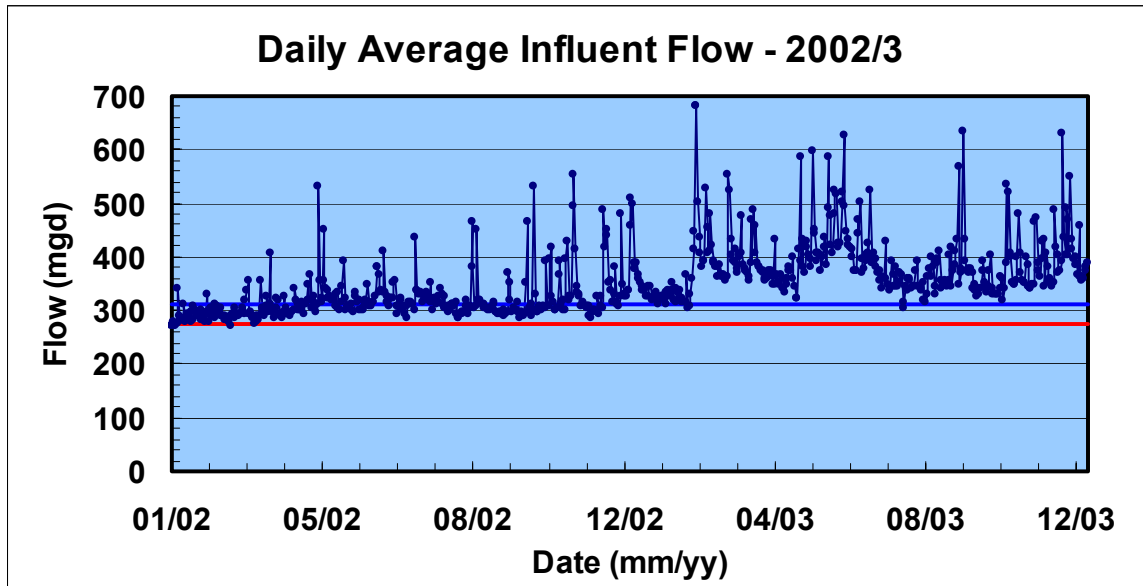

A characteristic dry weather diurnal pattern for each day of the week was established by averaging the flow values at each hourly increment for the identified dry days. The dry weather diurnal pattern is repeated closely from day to day on weekdays (Monday to Friday). The Saturday and Sunday patterns are similar to each other, but different from the pattern on weekdays. Figure 2-3 is a plot of the average dry weather diurnal patterns and shows that the increase in flow during the morning hours on weekends lags the increase on weekdays by approximately 2 hours. Based on the data, the diurnal flow factor, i.e. the ratio between the dry weather maximum hourly flows during the day to its average flow, is 1.07 (319 mgd/297 mgd) for weekdays and 1.12 (334 mgd/297 mgd) for weekend days. Therefore, the predicted maximum hourly flow rate during dry weather at the rated capacity of 370 mgd would be 414 mgd (370 times 1.12). The difference between the average flow and the maximum daily dry weather flow is low for Blue Plains because it has a large service area (approximately 725 square miles), it includes a 43 mile interceptor and the maximum diurnal flows from the various sub-sewersheds occur at different times (G&H, 2002). A smaller system would have a higher diurnal flow factor because the maximum diurnal flows from various parts of the collection system could arrive at the plant almost simultaneously.

As seen in Figure 2-4, average annual flows vary based on hydrologic conditions. Fluctuations in plant influent flow follow the fluctuations in rainfall and groundwater levels. Inflow and infiltration contribute to flows into the wastewater treatment plant during wet weather. In a combined sewer system, inflow enters the collection system through storm drains and is directly related to precipitation. Infiltration enters the system underground and is related to groundwater and rainfall that infiltrates into the ground. Therefore, the maximum monthly plant influent occurs simultaneous to periods of above average rainfall and high groundwater levels in the sewershed.

FIGURE 2-3

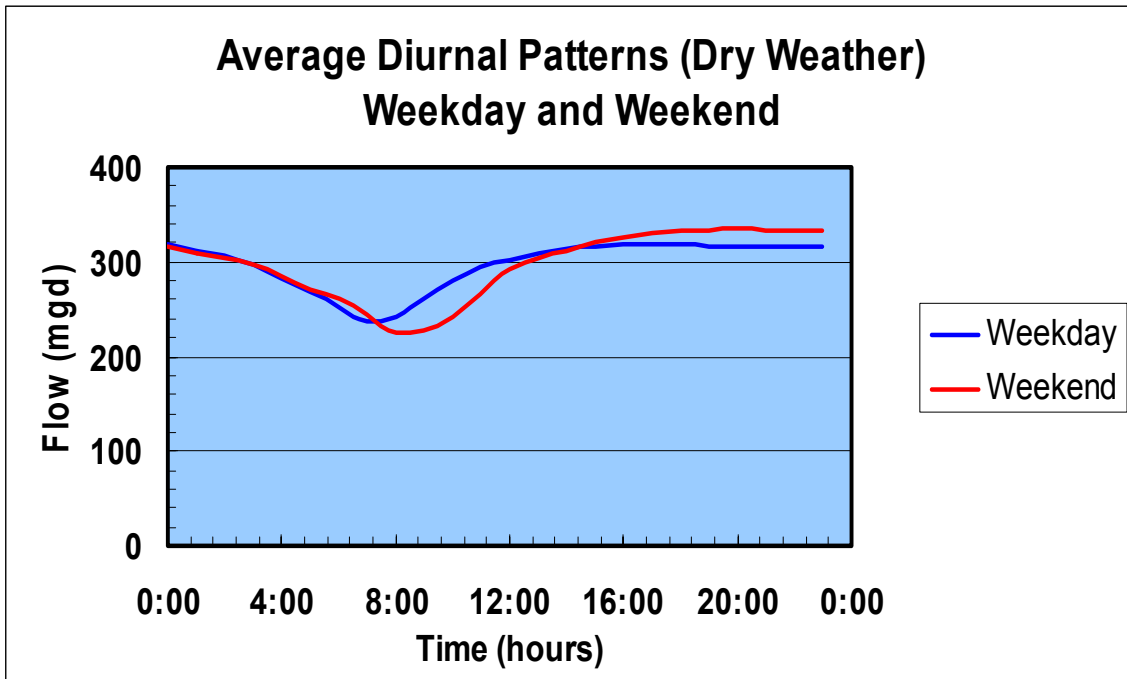
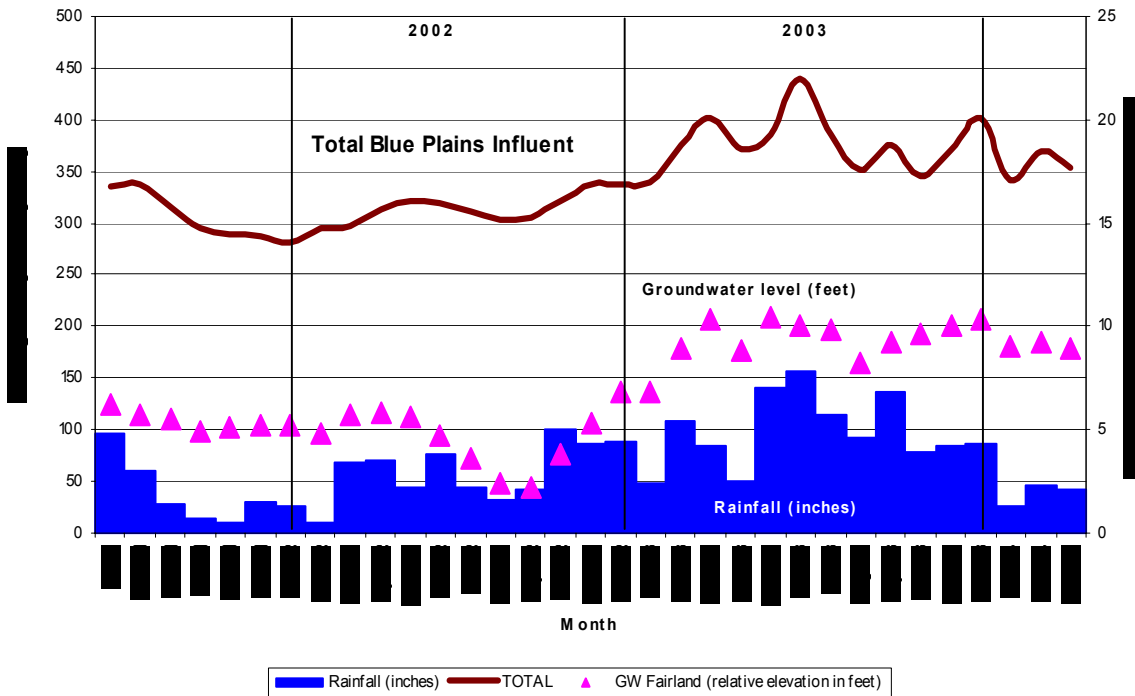

FIGURE 2-4
Blue Plains Monthly Influent Flow 2002-2004



Blue Plains Process Evaluation

Information on rainfall probabilities was obtained from the National Oceanic and Atmospheric Administration and was based on data collected at Washington Reagan National Airport during the years 1971-2000 (NOAA, 2002). Information on groundwater levels was obtained from the United States Geological Survey and was based on measurements taken in Fairland, Maryland from 1955-2004 at USGS well 390434076573002 MO Eh 20. This historical information was compared to plant influent flows to identify a maximum month condition.

Daily influent flows were analyzed for patterns of sustained high flows, i.e., maximum monthly plant influent. Years 2000, 2002 and 2003 were selected since the following range of hydrologic conditions occurred:

- Average - the year 2000 data indicates slightly above average rainfall (approximately 70th percentile) and average groundwater levels for the year (approximately 50th percentile).
- Dry - the year 2002 had significantly below average rainfall (approximately 20th percentile) and significantly below average groundwater levels for the year (less than 10th percentile).
- Wet - the year 2003 had significantly above average rainfall (greater than 90th percentile) and significantly above average groundwater levels for the year (greater than 90th percentile).

In addition, since this was a short period of time and annual plant influent flows have decreased in the years since 2003, it was assumed that no significant changes in sanitary flows occurred during the three-year period. Daily historical influent flow data for the years 2000, 2002 and 2003 were used to compute a peak to average ratio for monthly flow. This value, based on the ratio of the maximum 30-day flow to the average 30-day flow was 1.235. Application of this peak ratio to the plant average annual influent flow capacity of 370 mgd results in a projected maximum month flow of 457 mgd at design capacity.

2.2.3 Average Plant Influent Loads

Daily plant influent loading data for the years 2000, 2002, and 2003 were evaluated. As mentioned above, these three years were selected because a range of hydrologic conditions (groundwater level and precipitation) occurred during these years and it was assumed that changes in sanitary flows during the three-year period were not significant because the years were close in time and no dramatic changes to population and employment in the Blue Plains service occurred during this time. Table 2-2 presents the average daily value for the historical data set for plant influent flow, total suspended solids (TSS), biological oxygen demand (BOD), total phosphorus (TP) and total Kjeldhal nitrogen (TKN). Increasing the load in proportion to the increase in average annual flow resulted in an estimate of future plant influent average annual load for each constituent.

**Table 2-2
Projected Average Annual Blue Plains Plant Influent Flows and Loads**

Condition	Flow (mgd)	BOD (kips/day)	TSS ³ (kips/day)	TKN (kips/day)	NH3 (kips/day)	TP (kips/day)
Historical Annual ¹	Average 341	356	386	71	40	9
Projected Average Annual ²	370	386	419	77	43	9

¹Computed from daily influent values for the years 2000, 2002 and 2003

² Projected average annual flow is the rated capacity of the plant and the projected average loads are prorated based on the ratio of future to current flow.

³Influent total suspended solids concentrations have increased since 2003.

Blue Plains Process Evaluation

2.2.4 Maximum Month Plant Influent Loads

As described above, historical data from the years 2000, 2002 and 2003 were used to predict future influent flow patterns at Blue Plains. A peak to average ratio for monthly flow, 1.24, was computed from the historical data. Application of this peak ratio to the plant average annual influent flow capacity of 370 mgd results in a projected maximum month flow of 457 mgd when the plant has reached its design capacity. Probability curves were generated for 30-day rolling averages of plant influent loading of each of the selected constituents (TSS, BOD, TKN, NH₃, TP). The curves were used to define historical maximum monthly values and are included in Appendix A. Monthly to average ratios were computed and applied to projected average annual values to estimate future monthly loading. Table 2-3 shows the projected loadings that correspond to the projected maximum month flow. The values presented in Table 2-3 will be considered the design condition for sustained high flow through the wastewater treatment plant.

**Table 2-3
Projected Monthly Blue Plains Plant Influent Flows and Loads***

Column Number	(1)	(2)	(3)	(4)	(5)
			(2) ÷ (1)		(3) x (4)
	Historical Values*			Projected Values	
Parameter	Average Annual Plant Influent	Maximum Month Plant Influent	Maximum Month/Average Annual Peaking Factor	Projected Average Annual Plant Influent	Projected Maximum Month Plant Influent
Flow	341 mgd	420 mgd	1.24	370 mgd	457 mgd
	Load	Load		Load	Load
	kips/day	kips/day		kips/day	kips/day
TSS	386	477	1.24	419	518
BOD	356	416	1.17	386	451
TP	9	10.4	1.21	9	11
NH₃	40	52	1.30	43	56
TKN	71	84	1.18	77	91

*Based on daily plant influent data for the years 2000, 2002 and 2003

2.3 DESCRIPTION AND EVALUATION OF EXISTING FACILITIES

The plant liquid treatment processes, shown in Figure 2-1, consist of preliminary treatment, primary treatment, secondary treatment, nitrification/denitrification, post aeration, effluent filtration, and chlorination and dechlorination. The preliminary, primary and secondary treatment facilities are separated into East and West Processes. The Nitrification/Denitrification and Filtration and Disinfection facilities are separated into odd side and even side facilities. Chemical phosphorous removal is provided in the primary and secondary treatment processes. Biosolids handling processes include screening and dewatering of primary sludge, gravity thickening of primary sludge, dissolved air flotation thickening of biological sludge, sludge blending, dewatering, and biosolids cake post liming, storage and loading. Control and monitoring of process variables and equipment status is provided by a new Process Control System (PCS). The major process units provided at the plant are described in Table 2-4.

Blue Plains Process Evaluation

**Table 2-4
Process Facilities and Equipment at Blue Plains**

Facility/Units	#	Size	Flow, mgd/ Detention Time*
Liquid Treatment Facilities			
Raw Wastewater Pump Stations	13	¼" openings (1-40 mgd, 2-60 mgd, 3-80 mgd) (9-100 mgd)	1,300 mgd
Bar Screens	15		
Influent Pumps			
Grit Chambers			
Grit Chamber Building 1	4	75' long x 20.5' wide x 9.6' deep	4.3 min
Grit Chamber Building 2	12	70' long x 20' wide x 15' deep	4.2 min
Primary Sedimentation Tanks			
East Process	20	120' diameter x 13.7' deep	181 min
West Process	16	106' diameter x 14.4' deep	129 min
Secondary Reactors			
West Process (Reactors 1 & 2)	2	460' long x 116' wide x 15' deep	118 min
East Process (Reactors 3 & 4)	2	460' long x 116' wide x 15' deep	116 min
East Process (Reactors 5 & 6)	2	238' long x 80' wide x 15' deep	84 min
Secondary Sedimentation Basins			
East Process	12	260' long x 79.5' wide x 12.0' deep	150 min
West Process	12	250' long x 79.5' wide x 11.7' deep	210 min
Secondary Blowers	6	4 @ 40,000 cfm 2 @ 60,000 cfm	280,000 cfm
Nitrification/Denitrification Reactors	12 x 5 stages	249' long x 80' wide x 30.9' deep	195 min
Nitrification Sedimentation Basins	28	242' long x 79' long x 15.5' deep	219 min
Nitrification Blowers	5	5 @ 55,000 cfm	275,000 cfm
Dual Purpose Sedimentation Basins	8	310' long x 79.5' wide x 15' deep	68 min
Effluent Filtration System			
Multi-media Filters	40	52' long x 40' wide (2,080 sf/unit)	3.1gpm/ft2
Filter Influent Pumps	12	93.7 mgd	

Blue Plains Process Evaluation

**Table 2-4 (continued)
Process Facilities and Equipment at Blue Plains**

Solids Processing Facilities			Flow, Volume Solids Loading Rate
Primary Sludge Screening and Degritting Building Rotary Screens	4	¼" opening	
Degritter Feed Pumps	8	1,500 gpm	12,000 gpm
Grit Classifiers	4	3,000 gpm	12,000 gpm
Gravity Thickeners	8	65' diameter x 10' deep	12.8 lbs /day/sf
Dissolved Air Flotation Thickeners	18	20' wide x 5' long x 13' deep	38 lbs/day/sf
Sludge Blending Tanks	4	50' diameter x 17' deep	320,000 gal each
Dewatering Centrifuges	14	45 dry tons/day	150 gpm each
Dewatered Sludge Loading Facility Bunkers	4	62' long x 23' wide x 27' high	1,000 wet tons each
Direct Sludge Loading Station	1	4 main screw conveyors	55 wet tons/hr
Trucked Sludge Receiving Station	1	2 silos	600 wet tons each 55 wet tons/hr

*Assumes 370 mgd

2.3.1 Basis for Process and Facility Evaluations

Upgrading Blue Plains for higher levels of nutrient removal requires evaluation of the entire treatment system. Such an evaluation is necessary because the enhanced nutrient removal (ENR) processes are more sensitive to excursions of flow, high solids and BOD loading than the secondary treatment process. In 1998, WASA constructed the Denitrification Demonstration Facility which was a half-plant scale pilot testing of the ability to denitrify in the existing nitrification reactors. After the facility was constructed, detailed testing and evaluation was conducted over a one-year period. The process was optimized and operating parameters were determined. The piloting determined that secondary effluent total suspended solids (TSS) levels should be maintained below 20 mg/l to assure consistent performance to achieve the Chesapeake Bay Program (CBP) annual average goal of 7.5 mg/l of total nitrogen (TN) in the plant effluent. For Blue Plains to achieve annual average effluent TN levels of 4.2 mg/l, this secondary effluent target is even more critical.

A major upgrade of the treatment plant facilities and equipment is currently underway through WASA's Capital Improvement Program (CIP). The adequacy of the existing upgraded process facilities to reliably meet the final TN permit limit of 4.2 mg/l, while meeting all other NPDES discharge limits and handling peak wet weather flows has been assessed.

Blue Plains Process Evaluation

2.3.2 Preliminary Treatment Processes

The preliminary treatment processes consist of influent screens, raw wastewater pumping, and grit removal.

Historical Background

The six Raw Wastewater Pumps in Raw Wastewater Pump Station 1 (RWWPS 1), also referred to as the West Process, were installed as the first equipment at the Blue Plains site in 1935. These pumps were recently rebuilt. The nine pumps in the Raw Wastewater Pump Station 2 (RWWPS 2), also known as East Process, were installed in phases between 1968 and 1974. Three of the pumps were converted from dual-fuel engine-driven pumps to constant-speed pumps with synchronous motors in 1994. The remaining pumps have recently been rebuilt. The nine influent screens in Raw Wastewater Pump Station 2 were recently replaced with fine screens. The four screens in Grit Chamber Building 1 (West Process) were recently replaced with fine screens.

Process Description

West Process

Raw wastewater predominantly from the Main, "O" Street and Poplar Point pumping stations is delivered to RWWPS1 via the Outfall Sewer. The six pumps in RWWPS 1 lift the wastewater from an elevation of approximately 0 feet (range of -2 to +2 feet) to elevation +20 feet. Waste pickle liquor (ferrous chloride) or ferric chloride (both referred to as metal salts), and sodium hypochlorite can be added to the Outfall Sewer just upstream of the pump station. Additional feed points for metal salts are in the grit chamber effluent channel.

The pumps deliver the flow to four ¼-inch-opening fine screens. The screens remove a majority of debris and rags to prevent clogging of downstream equipment. The screenings are washed, compacted and conveyed by screws to remove excess water and organic material prior to disposal.

Following the screens are four aerated grit chambers. The grit chambers allow the heavier inorganic solids to settle out, while the lighter organic solids remain in suspension. Collected grit slurry is pumped to cyclones where excess water is removed from the grit prior to disposal. Both the collected grit and screenings are conveyed to a loading station for direct loading into trucks for off-site disposal.

East Process

Raw wastewater predominantly from the Potomac, Eastside and WSSC's Anacostia Pump Station #2 is delivered to RWWPS 2 via the Outfall Relief Sewers. One conduit can be dedicated to sanitary flow, and one to combined flow, depending on positions of upstream gates. Metal salts and sodium hypochlorite can be added individually to each of the conduits. Metal salts can also be applied to the grit chamber effluent as an alternate location.

On the east side, flow is first processed in nine fine screens, which are identical to those on the west side. Following screening, the flow is pumped by any of nine 100 MGD pumps. The pumps lift the flow from 0 feet (-2 to +2 feet) to an elevation of +20 feet. The pumped flow is discharged to the grit chamber influent channel, where it is distributed to twelve aerated grit chambers, similar to those on the west side. Screenings and grit conveyor systems are similar to those on the west side. An identical foul air system is also installed.

Evaluation

The condition of the Screening, Pumping, and Grit Removal facilities and systems has been significantly improved under the Capital Improvement Program. All screens have been replaced with fine screens and screenings compactors, conveyors and load out facilities have been installed. Pumps in both stations have

been rebuilt. The grit chambers have been rehabilitated and new traveling-bridge pumped grit removal systems have been installed. Grit conveyance and load-out facilities have been built. New chemical addition points (sodium hypochlorite and metal salts) were added in 2004 as part of the Additional Chemical Systems contracts. All of the upgraded preliminary treatment systems are monitored and controlled by the PCS.

Downstream processes have been noticeably free of debris since the startup of the fine screens. Clogging of the primary and secondary sludge pumps is now infrequent. The plant has the capability to screen all incoming flow as would be required for enhanced nutrient removal and ballasted flocculation processes that would be considered for separate wet weather treatment. The ballasted flocculation processes require fine screening to prevent clogging of the lamella tubes and other equipment.

The current permit requires a peak influent flow rate of 1,076 mgd to be delivered to the plant and receive preliminary and primary treatment. Raw Wastewater Pump Stations 1 and 2 have firm pumping capacities of 296 mgd and 780 mgd, respectively, which is adequate for the current peak flow condition of the permit. The fine screens are sized for 100 mgd each, which provides sufficient fine-screening capacity for the West and East Processes.

The aerated grit chambers are now routinely removing grit and lesser quantities are carried over to Primary Treatment, where the grit is removed with the primary sludge. The primary sludge degritting system can now be periodically taken offline without the gravity-thickened sludge pumps clogging with grit. This indicates that the aerated grit chambers are now performing better and at a level required for enhanced nutrient removal and ballasted flocculation processes that would be considered for separate treatment of combined sewer flows.

2.3.3 Primary Treatment Processes

Historical Background

The West Process Primary Treatment Facilities were constructed in the 1930's as part of the original plant construction and were rehabilitated once in 1979 and again in 2005. Primary Sedimentation Tanks 1 and 2 (formerly used for dewatered sludge cake storage) were rebuilt. The East Process Primary Treatment Facilities were constructed in 1972 rehabilitation of the sedimentation tanks was completed in 2006.

Process Description

The screened, degrittied raw wastewater from preliminary treatment flows to the primary sedimentation tanks. The Primary Treatment Facilities consist of 36 circular sedimentation tanks, arranged in clusters of four around a control house. There are four clusters in the West Process and five clusters in the East Process. The West Process has sixteen sedimentation tanks and treats about 40 percent of the total dry weather flow. The East Process has 20 tanks and treats the remaining 60 percent of the dry weather flow, as well as all of the storm flows in excess of 740 mgd. Flow into the tanks on the West side is evenly split among all 16 clarifiers. Flows to the East side are controlled by the number of grit tanks in service, and are not always evenly split. This causes overloading in some houses and can adversely affect solids removal. Wet weather flows are primarily handled in the East process, although the West side is capable of processing 296 MGD, which is twice the average day design flow for the West side primary treatment process. Each sedimentation process unit includes a tank, an energy-dissipating inlet influent baffle (EDI), a flocculating well, sludge and scum collector, turntable and drive unit, weirs, scum hopper and pump.

There are nine control houses, with each containing four variable speed primary sludge pumps (each with a flowmeter). The sludge pumping system is flexible in that one, two, or four pumps can be used per house using the tank valves when one pump is assigned to multiple tanks. Pumps are controlled by the

Blue Plains Process Evaluation

PCS. Pumping from each tank is approximately 15 minutes every hour. Settled primary sludge is pumped to one of three force mains and is conveyed to the Primary Sludge Screening and Degritting Building.

Each tank has its own scum hopper, with a pump for mixing and for delivery to the scum lines. Chemical F (polymer addition) can be dosed at either the control house influent wells (two per house) or directly to the tank influent. The polymer, in addition to the metal salts added to the plant influent, have together given enhanced primary treatment, with TSS removals approximating 60%. East and West Primary effluent flows through separate conduits and channels to the East and West Process Secondary Treatment Facilities, respectively.

Evaluation

The condition of the primary treatment equipment and support pumping systems has been significantly improved under the Capital Improvement Program. All 36 tanks have new collector mechanisms and all of the sludge and scum pumping systems have been replaced. The provision of energy dissipating inlets and flocculation wells provides the capability to operate in an enhanced mode with metal salts and polymer applied for increased performance, providing up to 60% TSS removal during dry weather flows. However, results are not consistent during wet weather flows. There is ongoing work to make improvements to optimize the system. The upgraded primary treatment systems are monitored and controlled by the PCS.

The ability of the plant to reliably and efficiently meet the final TN limit of 4.2 mg/l begins by optimal performance of the preliminary and primary treatment processes at all flow conditions. The ability of the primary treatment process to perform at an optimal level during storm events from 740 mgd up to 1,076 mgd does not currently exist. Under high flow conditions, TSS removal rates drop off to less than 10%. The provision of additional process tankage or a separate wet weather treatment system is addressed in Section 2.4.

Peak wet weather flows are handled by the plant's East Process primary treatment facilities. The Blue Plains primary treatment facilities were originally sized (1970's upgrade) for an annual average flow of 309 mgd, peak flow to secondary of 650 mgd and peak wet weather flow of 939 mgd. The treatment scheme included 3 separate biological processes (secondary, nitrification, and denitrification). Blue Plains was re-rated to 370 mgd annual average capacity with a peak flow to secondary of 740 mgd and peak wet weather influent flow of 1076 mgd. This re-rating did not include construction of added primary treatment capacity and was based on nitrification only, not BNR or ENR. Thus, as the plant capacity was increased and the level of treatment was increased, the capacity of the primary and secondary treatment facilities remained the same.

The capacity of primary treatment facilities is determined by a combination of criteria, which include depth, surface area and detention time. Table 2-6 presents the detention time and surface overflow rate for the current permitted flows and is based on 1 tank out of service for each West and East Primary.

Performance tests of the rehabilitated primary sedimentation tanks were performed in 2004 at various hydraulic loading rates. The performance results are shown in Figure 2-5. The tests included polymer and ferric chloride addition, which is routinely used for phosphorus removal and improved settling. The upgraded West Process primary sedimentation tanks provide relatively good levels of total suspended solids (TSS) and biological oxygen demand (BOD) removal up to the 296 mgd capacity of the West Process. Specifically, acceptable performance is removal of fifty percent (50%) of the influent TSS and twenty-five percent (25%) of the influent BOD in the primary process. At 740 mgd, the west process receives 296 mgd and the tanks have an overflow rate of approximately 2,200 gallons per day per square foot (gpd/sf).

Blue Plains Process Evaluation

Table 2-6
Primary Treatment Process Detention Time and Loading Rates
Average Annual, Maximum to Complete Treatment, Peak = 370/740/1076 MGD

West Primary (16 circular tanks, 106' diameter, 13.7 feet SWD)			
Plant Influent Flow (mgd)	Influent Flow to West Primary (mgd)	Detention Time (Hours)	Surface Overflow Rate (gpd/sf)
370	148	2.4	1,120
740	296	1.2	2,240
1076	296	1.2	2,240
East Primary (20 circular tanks, 120' diameter, 14.3 feet SWD)			
Plant Influent Flow (mgd)	Influent Flow to East Primary (mgd)	Detention Time (Hours)	Surface Overflow Rate (gpd/sf)
370	222	2.6	1,030
740	444	1.3	2,070
1076	780	0.7	3,630

The performance of the East Primary facilities up to 740 mgd was slightly less than for the West Process facilities. The performance declines considerably when influent flows to the plant exceed 740 mgd, as all of this additional storm flow is routed to the East Process. The East Process facilities are significantly overloaded at 1,076 mgd; as noted in Table 2-6 the overflow rate is greater than 3,600 gpd/sf. The TSS removal efficiency at 1,076 mgd is less than 10%. The existing primary treatment facilities are not adequately sized for flows greater than 740 mgd and cannot provide the level of treatment required for enhanced nutrient removal during storm events (Table 2-6).

FIGURE 2-5
Primary Sedimentation Tank Testing 2004

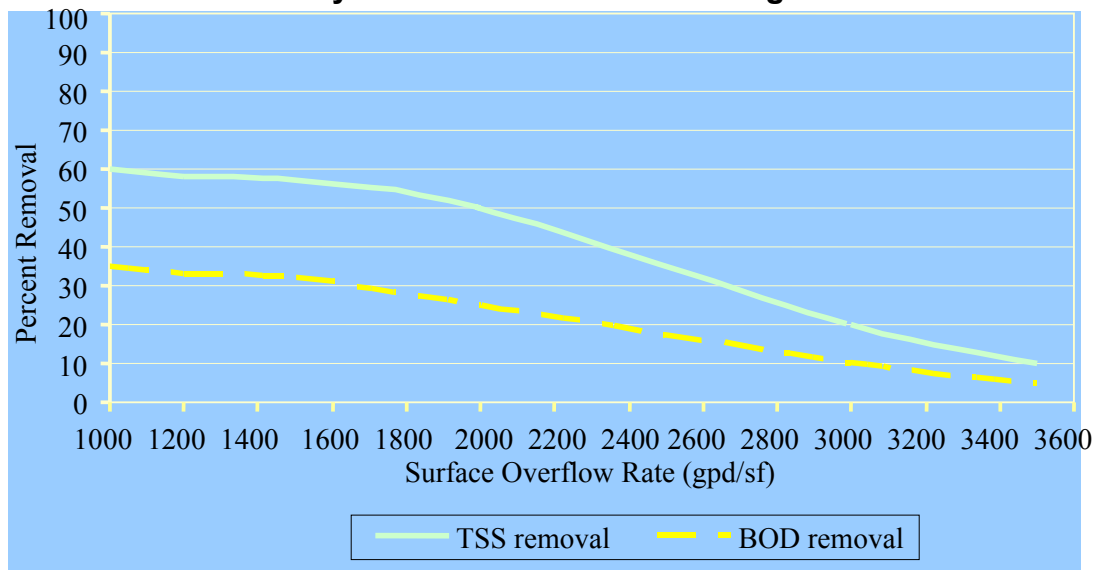

Blue Plains Process Evaluation

2.3.4 Excess Flow Treatment Facilities

Historical Background

The Excess Flow treatment system is designed to divert primary effluent flows above 740 mgd, up to 336 mgd, for the first four hours of a storm event to chlorine contact tanks for discharge from Outfall 001. The facilities include a flow diversion structure with flow metering and control system, four chlorine contact tanks, and a conduit that delivers the flow to Outfall 001. The Excess Flow Treatment facilities were constructed in the early 1970s for a peak flow of 289 mgd, without dechlorination. The peak flow to the Excess Flow facilities was increased to 336 mgd in 1997, without an increase in tank volume. Initially, disinfection was provided by liquid chlorine. In 2002, sodium hypochlorite replaced chlorine, using a temporary system. A permanent sodium hypochlorite began operation in 2004.

Process Description

The Excess Flow facilities consist of four diversion sluice gates at the diversion structure, flow metering system, and four chlorine contact tanks. Flow diversion to the chlorine contact tanks requires proper operation of two related flow control system. The East Primary to Secondary Flow Control System regulates the rate of flow to the East Process secondary reactors. The system includes venturi flow meters and large butterfly valves located in the conduits between the two treatment processes. During storm events, this system limits the flow to East Secondary to the rate that is required for the plant to treat up to 740 mgd for 4 hours and 511 mgd thereafter. The Excess Flow control system allows primary effluent flow above the rates that are discharged to Secondary to be diverted from the East Process to chlorine contact tanks for disinfection prior to discharge to the Potomac River through Outfall 001.

Evaluation

The condition of the flow control systems that control primary effluent flow to secondary treatment and excess flow to the chlorine contact tanks has been improved as part of the current Capital Improvement Program. The flow control systems are monitored and controlled through PCS.

2.3.5 Secondary Treatment Processes

Historical Background

The first Secondary Treatment facilities were constructed in the mid 1950s and included Secondary Reactors 1, 2, and 3, plus ten sedimentation basins. Reactor 4 and two more sedimentation basins were completed in 1962. The remaining reactors (5 & 6) and twelve additional sedimentation basins were completed in 1974. In 1997, the capability to operate the reactors in a step-feed mode was provided, as part of the expansion to 370 mgd. This change was necessary to provide the capability to store solids in the reactors during storm events to prevent overloading the sedimentation basins. Four of the six aeration system blowers were built with the original construction in 1955. Two additional blowers were installed in 1974, when Reactors 5 and 6 were constructed. A major upgrade of the facility will be completed in 2007.

The current secondary process facilities were originally designed for an average daily flow of 309 mgd and a peak flow of 650 mgd. The process was re-rated to 370 mgd average daily flow and 740 mgd peak flow without the expansion of aeration capacity. Eight dual purpose sedimentation basins were constructed in 1995 to augment both the secondary and nitrification processes.

Process Description

Secondary treatment is accomplished by means of a modified-aeration step-feed activated sludge process. The secondary treatment facilities are comprised of aeration basins called reactors, secondary sedimentation basins, sludge return and wasting systems, and the secondary blower facilities with associated blowers and diffusers. The secondary treatment process is the first of two activated sludge

Blue Plains Process Evaluation

systems and is followed by the Nitrification/Denitrification process. The secondary treatment process is a high-rate process with very low hydraulic and solids retention times. This process is effective for removing organic matter in preparation for nitrification.

The secondary treatment facilities include six reactors and twenty-four sedimentation basins. Reactors 1 and 2 and Sedimentation Basins 1-12 make up the West Process, and Reactors 3 through 6 and Sedimentation Basins 13-24 make up the East Process. The West Process is further divided into two independent process trains, West Odd and West Even. The reactors, designed as a four-pass system for operation in the plug flow mode, were modified in 1994 to implement step feed operation to enable the plant to store solids in up to three of the four passes during storm events. The six reactors have a total volume of 28 million gallons and a hydraulic retention time under 2 hours at the 370 mgd average daily flow rate.

Secondary aeration blowers supply oxygen to the reactors through coarse bubble diffusers to support the growth of microorganisms. In the presence of sufficient dissolved oxygen, organic matter in the wastewater is broken down and consumed by the microorganisms and new microorganisms are produced. This mixture of microorganisms and organic matter is known as “mixed liquor”. The mixed liquor flows to the sedimentation basins where solids-liquid separation takes place. Most of the settled mixed liquor (containing the microorganisms produced) is recycled as return activated sludge to the reactors to maintain the desired level of microorganism concentration in the process. Excess biological solids are pumped from the return sludge system as waste activated sludge to the Dissolved Air Flotation thickeners. Currently, all waste sludge from the nitrification/denitrification process is pumped to the secondary reactors. This is done primarily to promote some nitrogen removal in Secondary.

Each of the sedimentation basins has plastic chain and flight sludge and scum collection systems. The galleries house 36 return sludge pumps, six waste sludge pumps, and support systems. Polymer and metal salts are now being provided by the plant-wide chemical systems described elsewhere in this section.

Evaluation

The condition of the Secondary Treatment Facilities has been significantly improved as part of the current Capital Improvement Program. The secondary treatment facilities have been upgraded, including rebuilding the influent gates in the reactors, sludge and scum collection mechanisms in the sedimentation basins, return and waste sludge pumping systems, process aeration blowers, and other mechanical support systems, as well as the replacement of the concrete in the effluent end of the west process sedimentation basins above the water surface. The secondary treatment process systems and equipment are monitored and controlled by PCS.

As noted earlier, the secondary treatment system uses the modified aeration process which has a very short hydraulic retention time and a very low solids retention time. This process produces excess solids quickly as the biology is operated in the growth phase. As a result, the mixed liquor suspended solids concentration can increase quickly and overload the sedimentation basins when storm events produce increased flows.

The most important evaluation criterion for the secondary treatment system is the sedimentation basin capacity. As noted earlier, in-depth process monitoring and evaluations conducted for the Denitrification Demonstration Facility determined that secondary effluent total suspended solids (TSS) levels should be maintained below 20 mg/l to assure consistent performance to achieve an annual average goal of 7.5 mg/l of total nitrogen in the plant effluent. For Blue Plains to achieve an annual average effluent TN level of 4.2 mg/l, this secondary effluent target is even more critical.

A review of recent plant data indicates the plant can produce an effluent TSS concentration less than 20

Blue Plains Process Evaluation

mg/l during dry weather conditions, but not during wet weather. This can be explained by the procedures that are used in preparation for and after a storm event. The capability to operate the plant in various step feed modes was provided in 1997 so that the plant could store solids in the reactors during storm events to prevent overloading the sedimentation basins. The step feed mode is used in the following manner. When a wet weather event is approaching, the secondary reactors are switched into various wet weather modes depending on how well the sludge is settling. The intent of the wet weather modes is to hold some solids in the reactors to prevent overloading the sedimentation basins and consequent solids washout. For the secondary reactors, approximately 12 hours before the peak flow is to arrive at the plant, the influent gate to Pass 1 is closed and secondary effluent is fed to Passes 2, 3 and 4. Figure 2-6 shows the operating modes for the secondary reactors.

After the peak flow subsides, pairs of secondary reactors are put back into dry weather mode every 8 hours. The reason for placing the reactors back slowly is to prevent overloading the sedimentation basins with the solids that were stored in the reactors during the storm. The secondary treatment process can handle sustained high flows up to 450 mgd in normal operating mode.

A comparison of the design criteria for the Blue Plains secondary sedimentation basins with industry design criteria is presented in Table 2-7. As shown, the surface overflow rates for the East and West Process sedimentation basins are substantially higher than the design standards at both average and peak rates. The East Process basins are loaded at nearly double the design standard at the 740 mgd peak flow rate. As a point of comparison, the secondary clarifiers provided at the Deer Island wastewater treatment plant were designed with a surface overflow rate of 1,000 gpd/sf, at peak flow. This plant is used for comparison because it was recently constructed, is of similar size to Blue Plains, and the influent characteristics are similar as a portion of the service area has combined sewers.

Flow, mgd , includes Recycles Total Avg = 389 mgd Total Peak = 760 mgd	Number		Dimension	Surface Overflow Rate gpd/sf		Solids Loading Rate lbs/sf/day	
	Total	On-line		Avg	Peak	Avg	Peak
Ten States Standards					1000-1200		50
East Process Avg day = 226 mgd Peak = 448 mgd	12	11	260' long x 79.5' wide x 12.0' deep	994	1,972	25	41
West Process Avg day = 163 mgd Peak = 312 mgd	12	11	250' long x 79.5' wide x 11.7' deep	747	1,425	20	31

The existing secondary sedimentation basins are not adequately sized for flows greater than 555 mgd and cannot provide the level of treatment required for enhanced nutrient removal during storm events or periods of extended high flows due to wet hydrologic years. The 1970s design for advanced wastewater treatment reserved space for an expansion of Secondary Reactors 5 and 6 to double their size. This expansion should be included in an upgrade for enhanced nutrient removal to provide increased aeration capacity in the secondary process.

FIGURE 2-6
Secondary Process Operating Modes

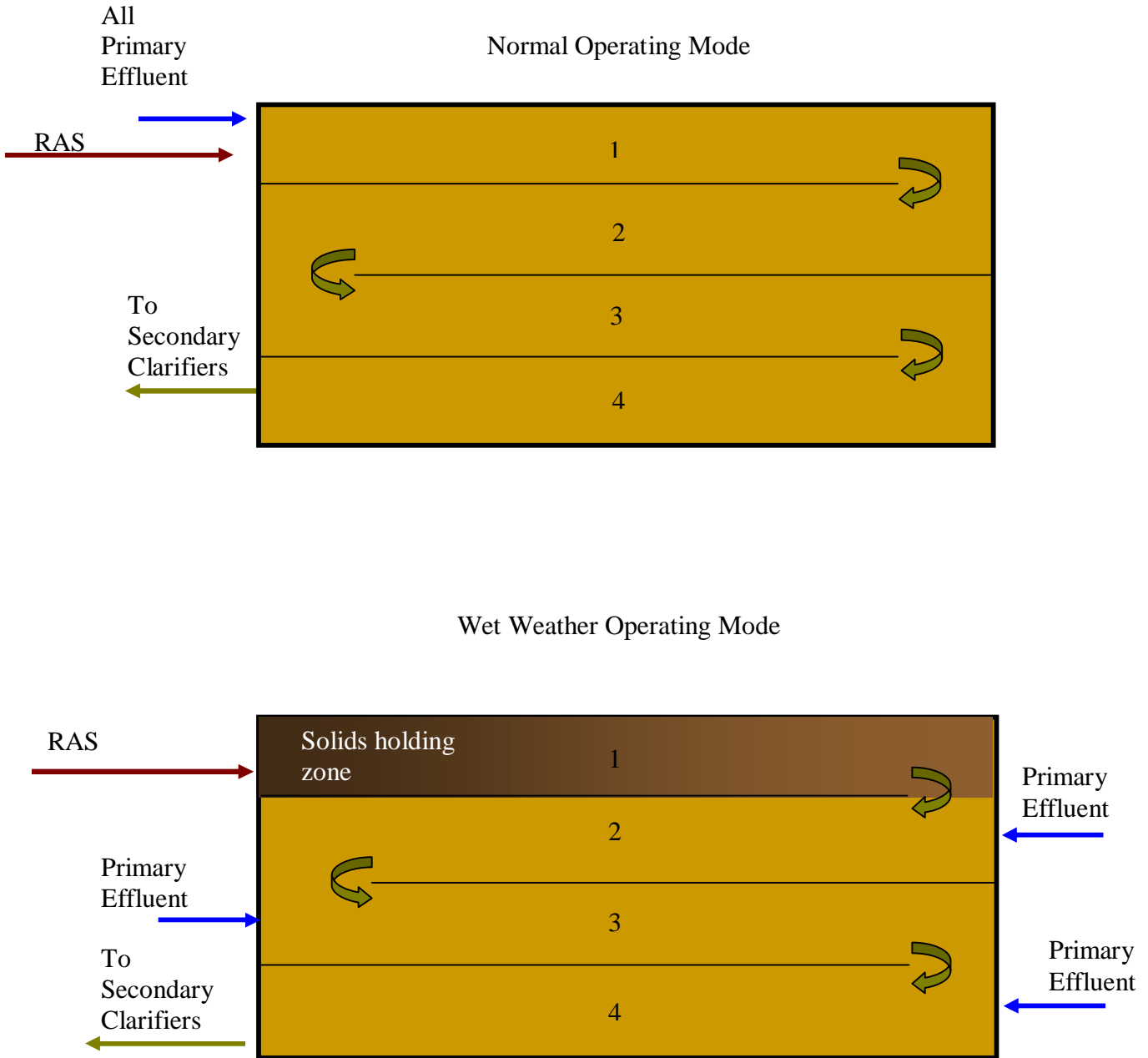

Blue Plains Process Evaluation

2.3.6 Nitrification/Denitrification Treatment Process

Historical Background

The Nitrification Process, started up in 1980, was designed for an average daily flow of 309 mgd and a peak flow of 650 mgd. The process was re-rated to 370 mgd average daily flow and 740 mgd peak flow without the expansion of reactor aeration capacity. Eight dual purpose sedimentation basins were constructed in 1995 to augment both the secondary and nitrification processes, as part of the expansion to 370 mgd. In 1996, a methanol feed system was built to provide the capability to denitrify the wastewater in the evenside process, as a piloting-demonstration test. These modifications included provision of methanol storage and feeding facilities. After a successful demonstration of half-plant denitrification, similar methanol storage and feed facilities were constructed in 1999 to provide full plant denitrification to meet a goal of 7.5 mg/l of TN on an average annual basis.

Process Description

The nitrification/denitrification process, similar to the secondary treatment process, is a suspended growth biological system consisting of reactors and rectangular sedimentation basins. The nitrification process facilitates the oxidation of ammonia nitrogen to nitrate nitrogen resulting in decreased oxygen demand on the Potomac River from the plant effluent. The denitrification process uses methanol as a food source to support the growth of microorganisms that convert the nitrate nitrogen to nitrogen gas.

Secondary effluent flows into a stilling basin at the head of the nitrification reactors. If necessary, sodium hydroxide (caustic) is added to the secondary effluent stream upstream of the stilling basin to provide alkalinity that is consumed during the nitrification process. If denitrification is occurring, little or no caustic is needed. The flow from the stilling basin is hydraulically split to distribute flow between the odd-numbered reactors and the even-numbered reactors. Each reactor has five stages and each stage is equipped with two turbine aerators. The turbine aerators maintain dissolved oxygen levels and provide adequate mixing to keep solids uniformly distributed in Stages 1, 2 and 3 for nitrification while denitrification occurs in the last two stages. Methanol is added in stage four to provide a source of carbon for the denitrifying organisms. Stages 4 and 5 are not aerated but are operated in an anoxic mode to allow denitrification to occur. The process now employs the same mixed liquor to support both the nitrifying and denitrifying bacteria. Mixed liquor from the odd and even side reactors flows to their respective sedimentation basins. The settled solids are pumped back to the reactors, as return activated sludge, and excess biological solids are wasted to Secondary.

The equipment installed for methanol consists of four underground and three above-ground storage tanks with transfer pumps, a day tank, 24 methanol metering pumps, monitoring and control equipment, and associated piping, valves and appurtenances. Due to the flammability of the methanol, a fire suppression system is also provided.

The Nitrification/Denitrification process has 12 reactors and 28 sedimentation basins. The plant has the capability to use up to 8 dual purpose sedimentation basins to augment the 28 dedicated basins. The sedimentation basins have plastic chain and flight sludge collection mechanisms. Nitrification aeration system components include five process air blowers and associated piping and valves to distribute air to the reactors and channels.

Alkalinity needs are currently met with the Interim Sodium Hydroxide facilities (completed in 2001). These facilities include 5 storage tanks and 3 feed pumps. The total volume of storage is over 30,000 gallons. Polymer and metal salts can be added to the sedimentation basins from the centralized plant-wide chemical systems described elsewhere in this section.

Blue Plains Process Evaluation

Evaluation

A project is underway to provide a major upgrade of the nitrification/denitrification facilities. This project will provide a rehabilitation or repair of the major process equipment that is nearing the end of its useful life. This contract will also provide improvements to more evenly distribute flows to both the reactors and the sedimentation basins. The scope of work includes the following:

- Improve flow split to the reactors
- Provide automated Dissolved Oxygen (D.O.) control
- Replace sluice gates and refurbish actuators
- Modify mixers and add some mixers
- Provide instrumentation for automated monitoring and control
- Provide new sludge collection equipment
- Replace scum collectors and pumps
- Provide fine bubble diffusers in stages 1, 2, 3, and 5
- Rebuild the aeration blowers and provide new blower controls
- Improve flow distribution to sedimentation basins
- Improve flow splitting between nitrification sedimentation basins and dual purpose sedimentation basins
- Provide monitoring and control by PCS

Reactor Capacity Evaluation

WASA has operated the full-plant BNR system since 2000 to meet a goal of 7.5 mg/l total nitrogen on an annual average basis, or 8.4 million pounds per year. As shown, performance has been variable; however, the plant has met the goal defined in the permit. The variability of performance is best explained by reviewing effluent TN concentrations, along with flow and temperature data, as shown in Figure 2-7.

Wastewater Temperature and Flow. Daily temperature of the wastewater is shown in green and the green line shows the 7-day moving average (MA) of temperature. The 30-day MA of plant effluent flow is shown as a red line. As Blue Plains receives wet weather flow, the wastewater temperature (and TN removal performance) is significantly impacted by a combination of temperatures and precipitation during the January to April period. Year 2002 was a very dry year with low precipitation during the January to April period and had the highest wastewater temperatures during this period. Year 2003 and into 2004 was a wet period and had the lowest wastewater temperatures during the corresponding January to April periods. The above average rainfall increased the groundwater table throughout the Blue Plains service area and significantly increased infiltration for an extended period of time.

Effluent TN concentration. Daily effluent TN concentrations are shown in brown and a 30-day moving average (MA) was applied, as shown by the brown line. The data shows that effluent TN performance degrades significantly when temperatures fall below 13° C. It is also noted that during the coldest winter months, the poorest TN performance lags the coldest temperatures. This is the result of switching one stage of the reactors from an anoxic stage (denitrification) to aerated stage (nitrification) so that WASA can protect the nitrifying organisms and continue to meet the permit requirement for ammonia nitrogen. In addition, it takes weeks to re-establish the growth rate and amount of denitrification organisms after a cold period.

Annual TN Load. The annual TN load, shown by the orange line, is the cumulative sum of the daily TN load values over each year, starting on January 1st of each year. Daily TN load is calculated as follows: [flow (mgd) x TN concentration (mg/l) x 8.34]. As shown, WASA has met the TN goal of 7.5 mg/l in each of calendar years in the figure; however annual performance is very dependent on temperature and rainfall-induced infiltration during the cold-weather months, which are beyond WASA's control.

Figure 2-7
Historical Performance of Nitrogen Removal at Blue Plains

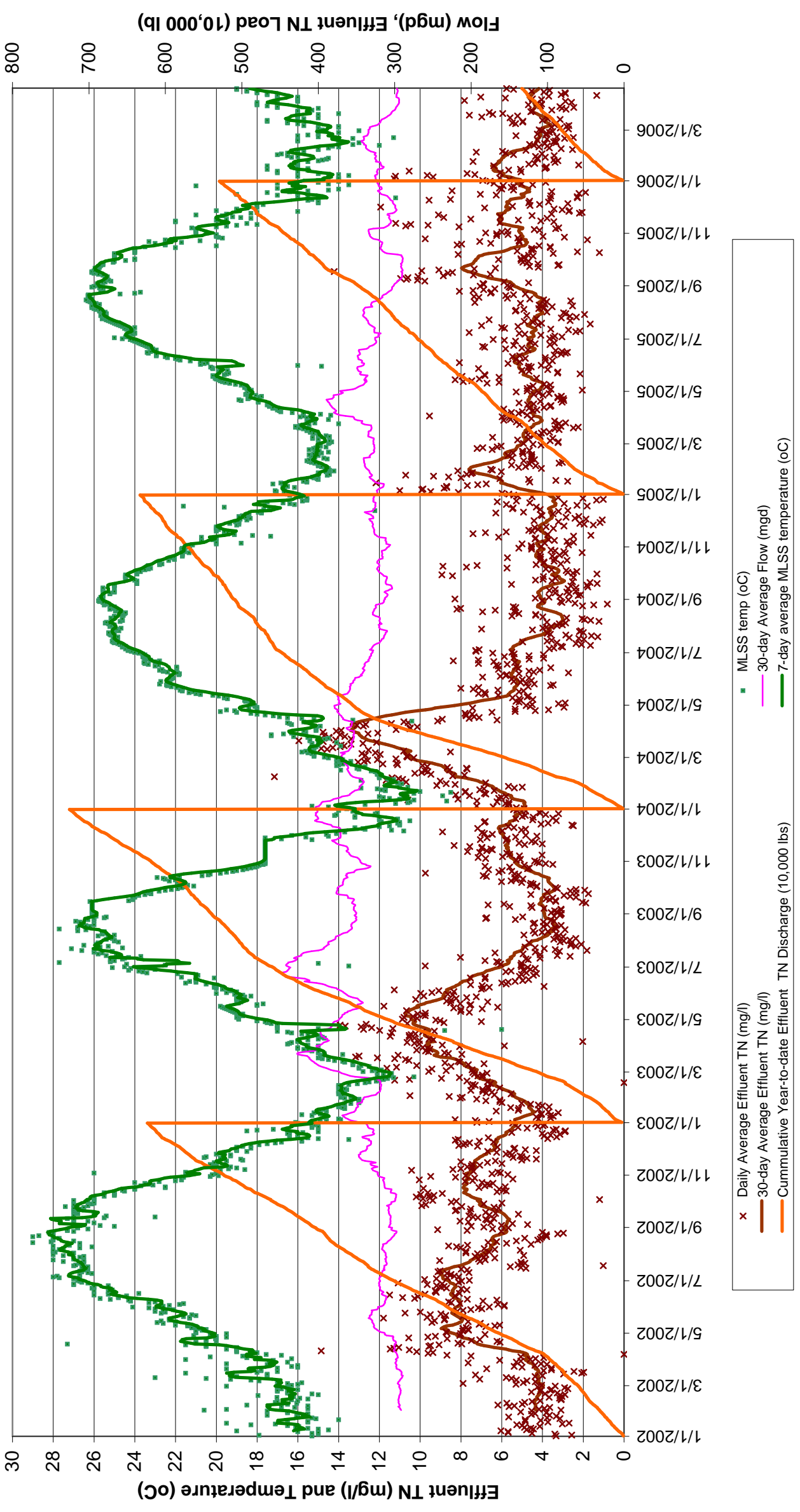

Blue Plains Process Evaluation

It is also noted that flows were limited to a peak of 511 mgd to Complete Treatment during the entire period shown. Had the BNR process been required to treat peak flow up to 740 mgd, the plant would not have met the TN goal in several years. It is clear that the existing reactors that were designed for nitrification only for a design flow of 309 mgd are not adequately sized for simultaneous nitrification and denitrification at 370 mgd average daily flow and that additional capacity is required to meet the final TN permit limit of 4.2 mg/l at 370 mgd.

Sedimentation Basin Evaluation

Another important evaluation criterion for the Nitrification/Denitrification process is the sedimentation basin capacity. A review of recent plant data indicates the Nitrification/Denitrification process can produce an effluent TSS concentration less than 10 mg/l during dry weather conditions, but not during wet weather. This can be explained by the procedures that are used in preparation for and after a storm event. The capability to operate the plant in various wet weather modes was provided in the mid 1990s so that the plant could store solids in the reactors during storm events to prevent overloading the sedimentation basins. The wet weather modes are used in the following manner. When a wet weather event is approaching, the Nitrification/Denitrification reactors are switched into various wet weather modes depending on how well the sludge is settling. The wet weather modes hold solids in the reactors to prevent solids washout. Figure 2-8 shows the operating modes for the nitrification/denitrification reactors. If the settling rate is poor and a storm is predicted that day, 6 reactors are placed in return only operating mode and 6 reactors are placed in wet weather operating mode. The return only mode stores return sludge, which continues to be fed to the reactor. Since no secondary effluent is fed to the reactor, the reactor is essentially off line and provides no nitrification or nitrogen removal. In wet weather operating mode, the return sludge is fed to Stage 1, and all of the secondary effluent is fed into Stage 2. As sludge is stored in Stage 1, the capacity of the reactor to nitrify and denitrify is reduced.

After the peak flow subsides and lower flows are projected for more than a day, the 6 reactors that are in return only mode are placed in wet weather mode, 2 at a time over a 24-hour period. Once all the reactors are in wet weather mode, pairs of reactors (one even, one odd) are placed in normal mode every 8 hours. It is noted that it takes 3 days after the storm to get the 6 reactors in return only mode back in wet weather mode and another 2 days to return all of the 12 reactors to dry weather mode. Nitrogen removal is reduced during this 5-day period after the storm event.

A comparison of the design criteria for the Blue Plains Nitrification/Denitrification sedimentation basins with industry design criteria is presented in Table 2-8. As shown, the surface overflow rates for the Nitrification/Denitrification sedimentation basins are substantially higher than the design standards at both average and peak rates. The existing basins are not adequately sized for flows greater than 555 mgd and cannot provide the level of treatment required for enhanced nutrient removal during storm events.

FIGURE 2-8
Nitrification/Denitrification Process Operating Modes

Normal Operating Mode (NOM)

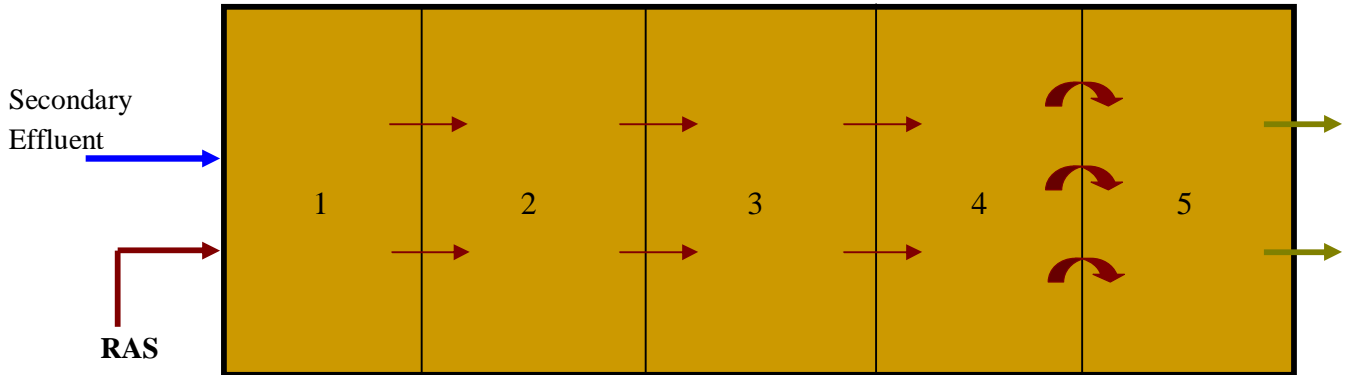

Wet Weather Operating Mode (WOM)

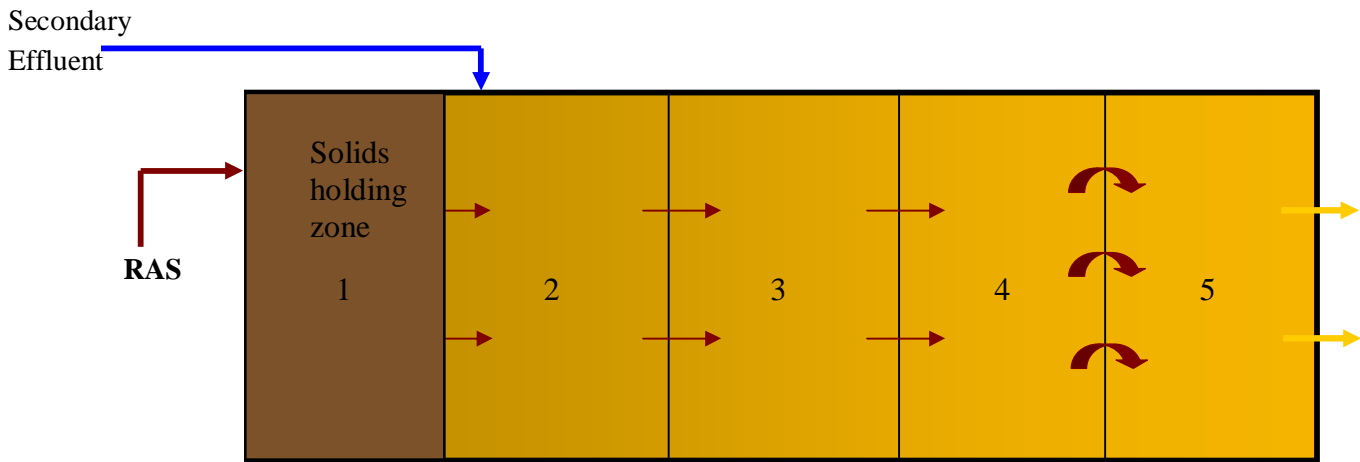

Return Only Operating Mode (ROM)

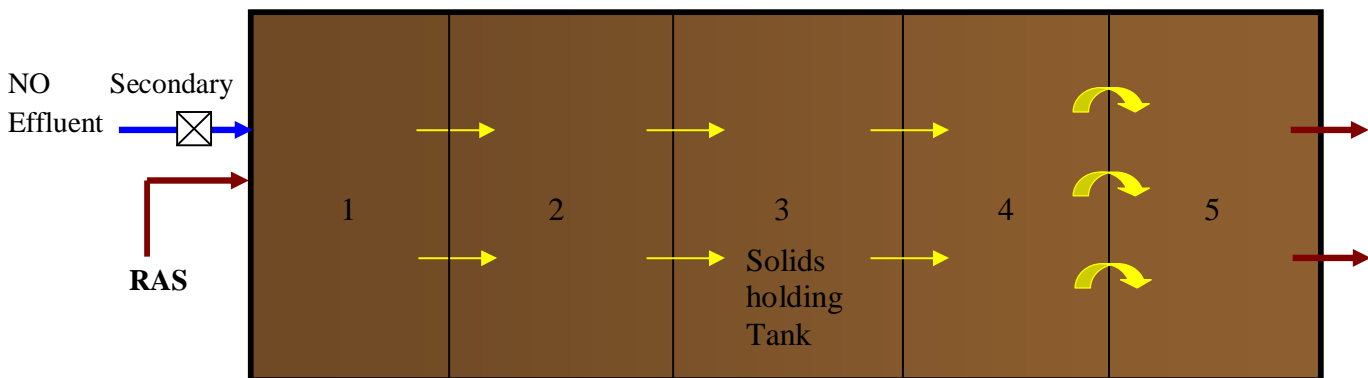

**Table 2-8
Industry Standards for Nitrification Sedimentation Basin Hydraulic Loading Rates***

Flows, mgd, includes recycles	Number		Dimension	Surface Overflow Rate gpd/sf		Solids Loading Rate lbs/sf/day	
	Total	On-line		Avg.	Peak	Avg.	Peak
Avg day = 407 mgd Peak = 874 mgd							
Ten States Standards					800		35
Nitrification/Denitrification Sedimentation Basins	28	26	242' long x 79' wide x 15.5' deep	608	1,305	25	31
Dual Purpose Sedimentation Basins- all basins in nit/denit service	8	7	310' long x 79.5' wide x 30.9' deep				

*Rates given are for nitrification system, however Blue Plains experience is consistent with these values.

2.3.7 Dual Purpose Sedimentation Basins

Historical Background

The Dual Purpose Sedimentation Basin (DPSB) facility was placed in service in 1995, as part of the plant expansion to 370 mgd, and has been in continuous service since then. The eight small return sludge pumps were replaced with larger pumps in 2004.

Process Description

There are eight dual purpose sedimentation basins, each of which can be used for settling mixed liquor from either the secondary or nitrification process. The DPSBs are approximately 25% larger than the secondary or nitrification basins; thus 8 DPSBs are equivalent to 10 secondary or nitrification basins. While originally anticipated to serve primarily in the nitrification process, any number of these units may be placed in secondary service if sludge settleability is poor or when multiple secondary sedimentation basins are taken out of service for maintenance or construction. This feature was used during construction of Secondary Treatment Facilities Upgrade contracts. Secondary effluent flows from the dual purpose sedimentation basins are pumped to the nitrification process by screw pumps. Nitrification effluent flows are routed directly to the Filtration Facility forebays. All solids collected are returned to either the secondary or nitrification reactors, as appropriate.

Evaluation

The dual purpose sedimentation basins are relatively new. The basins were routinely used for the nitrification process until the denitrification demonstration facility went into operation. At that time it was demonstrated that the BNR process required a high quality secondary effluent and some of the basins were switched to the secondary treatment process. This facility will play a critical role in meeting the enhanced nutrient removal requirements, by providing added settling capacity for primarily the ENR process. A project is in place to convert monitoring and control from a PLC-based system to PCS.

Blue Plains Process Evaluation

2.3.8 Filtration and Disinfection Facility

Historical Background

The Filtration and Disinfection Facility was placed into full service in 1984 with 36 filters. In 1994, four additional filters and two additional Filter Influent Pumps were installed as part of the expansion to 370 mgd. All pumping systems in this facility were recently replaced.

Process Description

The filtration process is required to remove solids from the nitrification effluent flow to enable the plant to meet the stringent phosphorous limitation of the NPDES permit. The filtration facility has 40 dual-media filters (anthracite coal and sand) through which wastewater flows and deposits solids.

The Filtration and Disinfection Facility consists of 12 filter influent pumps, 40 filters with associated washwater valves and filter rate controllers, an automated backwash system with washwater, and spent washwater pumps. The disinfection tanks are located beneath the filters. In addition, two plant water systems draw filtered water from the north end of the filtered water conduits to provide process and service water (PSW) needs for the entire plant. The facility has two fore bays that serve as wet wells for the filter influent pumps, which can be operated independently or together. The filter influent pumps lift the BNR effluent to the filter influent conduits and channels. The filters each are divided into two halves, which are backwashed separately.

The filters are arranged into four filter wash groups, each with ten filters. Each filter wash group has two washwater pumps. Spent washwater flows to a spent washwater well where five spent washwater pumps are used to return the water from backwashing to the upstream processes. There are three low-pressure and three high-pressure reclaimed final effluent pumps and four chlorine injector water pumps. A new outfall sampling system was started up in 2004.

Evaluation

The effluent filters were recently rebuilt with new underdrain systems, troughs, and filter media. A temporary air wash system was provided and is in use. An interim PCS system is in place to provide automated filter backwashing. A project is underway to upgrade all of the filtration and backwash systems and provide permanent blowers for the air water wash system. The upgraded filters provide sufficient capacity to remove solids and phosphorus to meet the permit limit. All systems will be monitored and controlled by the permanent PCS as part of the ongoing project.

2.3.9 Primary Sludge Screening and Degritting Process

Historical Background

The primary sludge screening and degritting facility, originally constructed in 1989 and modified several times since, pre-treats primary sludge to remove scum, grit, and fibrous material prior to primary sludge thickening.

Process Description

The treatment processes consist of four rotary screens and two conveyance trains to remove rags, two scum screening trains consisting of scum screen and a conveyance system, wet well, eight trains of cyclone degritters and feed pumps, 4 trains of grit classifiers. The mechanical systems in this building were recently replaced and the systems are monitored and controlled by the Process Control System.

Evaluation

The equipment in this facility was recently upgraded and should be capable of handling additional sludge

produced by a wet weather treatment system. However, this facility will be checked during concept design of any new wet weather treatment system.

2.3.10 Gravity Thickening Process

Historical Background

This process consists of 8 gravity thickeners that are used to thicken primary sludge from 0.5- % solids concentration to 5–7% solids concentration. Initial construction began in 1958, four additional units were constructed in the 1990s and upgrades to four of the original units have recently been completed

Process Description

Dilute primary sludge is pumped to the gravity thickeners. Each thickener includes a tank, sludge and scum collector, a paired sludge pumping system, and shared scum pumping systems. Thickened sludge is pumped from a sump located at the bottom of the tank.

Evaluation

The upgraded gravity thickeners should be capable of handling additional sludge produced by a wet weather treatment system. However, this facility will be checked during concept design of any new wet weather treatment system.

2.3.11 Dissolved Air Flotation Thickening Process

Historical Background

The Flotation Thickener Facilities were constructed in 1977 and upgraded in 1998. A project is underway to completely rehabilitate the thickeners.

Process Description

The process has eighteen dissolved air flotation (DAF) thickeners that are used to thicken biological sludge from the secondary and nitrification processes, as well as scum from gravity thickening. Five flow distribution boxes serve groups of 3 or 4 thickeners. Each DAF unit is comprised of a tank, top collector mechanism, sludge well, thickened sludge pump, air retention tank, recycle pump system, polymer feed pumping system, and associated piping, valving, and control systems. The process is served by a central air compressor system, and a polymer day tank system that is supported by the plant-wide Polymer System and transfer pumps. Process control is provided through local flow-based program logic controllers.

Evaluation

The upgrade project for this facility will provide a comprehensive upgrade of the process systems and equipment and will provide for monitoring and control by PCS.

2.3.12 Anaerobic Digestion Process

The existing anaerobic digestion facility, constructed in 1935 and 1946, was decommissioned in December 2000 due to age and safety concerns. A new Egg-shaped Digestion Facility (EDF) was designed to produce Class A biosolids that are stable, of low odor potential and of consistent quality. The process would reduce the total mass and volume of sludge produced by approximately 50 percent, and significantly reduce truck traffic, pollution, noise and odor.

Phase 1 of the project bid in 2006. However, WASA decided to reject the single bid received and defer the project for 3 years. A revised strategy for long-term biosolids management is under preparation. This strategy will involve monitoring of: 1. the construction bidding environment, 2, evolving technologies

Blue Plains Process Evaluation

that could be employed, and 3. regulatory initiatives that may impact land application of biosolids products.

The anaerobic digestion process produces a centrate which is high in ammonia when the sludge is dewatered for transport. This centrate is recycled to the main wastewater process for treatment. Although the centrate flow rate is projected to be less than 2 mgd, the centrate recycle stream is projected to increase the nitrogen load into the nitrogen removal process by approximately 30%. To meet the effluent TN limit, a separate centrate treatment facility will be required to remove this additional load.

2.3.13 Sludge Dewatering, Post-Liming and Storage Processes

Historical Background

The Solids Processing Building was constructed in 1974. With more than 10 different projects since then, these facilities have undergone extensive evolution in treatment technologies application. Of the original construction, only the sludge blending tanks are still in use; these were rehabilitated and upgraded in 1999. One of the 14 centrifuges was installed in 1984, six more were installed in 1991, and seven more in 2004. Each centrifuge is supported by two centrifuge conveyors, two polymer feed pumps, two sludge feed pumps, and extensive piping, instrumentation and controls. Four conveyor trains convey sludge to the biosolids storage facility. Polymer for the centrifuges is currently provided by the new Chemical R Emulsion Polymer System located in the basement of the Chemical Building, and the new Plantwide Polymer Process located in the adjacent building. Following dewatering, the dewatered sludge is treated with lime (15-25% of dry weight) and conveyed to the biosolids storage and truck loading facility. The liming process is supported by two lime storage silos, four trains of air blowers, lime filter/receivers, day tanks, lime feeders, and new mixers.

The Biosolids storage and truck loading facility consists of: a Direct Sludge Loading Station that is equipped with its own lime system, conveyance system, two mixers, and direct sludge loading station; a Dewatered Sludge Loading Facility (DSLRF) that is comprised of four storage bunkers, two sludge silos with live bottom truck loading capability (including truck scales and weigh ticketing systems), three odor control units, and a Trucked Sludge Receiving Station (TSRS) that receives sludge from trucks and pump it to the bunkers/silos, with or without reliming.

Evaluation

The wet weather treatment and ENR processes will produce added solids that will require dewatering. This facility should be capable of handling these added solids. However, this facility will be evaluated as part of the conceptual design of the ENR facilities.

2.3.14 Plant-wide Chemical Systems – Chlorination systems

Historical Background

A new Chlorination Building that provides central receiving, storage, and pumping of sodium hypochlorite was placed in service in 2004. The Standby Chlorination/Dechlorination Building provides standby chlorination and dechlorination feed pumps for use with tanks trucks for emergency use.

Process Description

The Chlorination Building serves as the primary storage and dosing facility for the disinfecting chemical, sodium hypochlorite. Sodium hypochlorite is used for odor control of plant influent, disinfection of the final effluent and storm-related excess flow, and to control nuisance organisms in the biological processes. The Chlorination Building has eight storage tanks, each with a capacity of 19,700 gallons. Total capacity is 157,600 gallons. The system has the flexibility to transfer the contents of one tank to any other tank.

Eleven feed systems, each with a single pump, provide for chlorination of influent (3 pumps), secondary return sludge (5 pumps), nitrification return sludge (2 pumps), and gravity thickener dilution water (1 pump). The remaining three systems are used for effluent chlorination (oddside, evenside, and excess flow). Each of the effluent systems has redundant pumps. The final plant effluent, excess flow effluent, and influent chlorination systems are flow paced, whereas the return sludge and dilution water chlorination systems must be manually adjusted. The excess flow system control strategy permits automatic startup of the chemical feed pump when excess flow is detected at Meter 104.

Evaluation

All of the systems were placed in service in 2004, and all are functional. Adequate capacity is provided in both of the chlorination systems for Outfalls 001 and 002 at all flow conditions.

2.3.15 Plant-wide Chemical Systems - Dechlorination Systems

Historical Background

The Dechlorination Building was renovated in 2004 to provide centralized receiving, storage and pumping of sodium bisulfite, which is used to dechlorinate the plant's final effluent and storm-related excess flow.

Process Description

The Dechlorination Building has eight storage tanks, each with a nominal capacity of 6,000 gallons. Total storage capacity is 48,000 gallons. The system has the flexibility to transfer the contents of one tank to any other tank. Chemical dosing is flow paced. The excess flow system control strategy permits automatic startup of the chemical feed pump when excess flow is detected at Meter 104.

Standby dechlorination pumps are installed in the Standby Chlorination/Dechlorination Building for use with a tank truck for an emergency.

Evaluation

All of the systems were placed in service in 2004, and all are functional. Adequate capacity is provided in both of the dechlorination systems for Outfalls 001 and 002 at all flow conditions.

2.3.16 Plant-wide Chemical Systems - Metal Salts Addition

Historical Background

A new centralized plant-wide metal salt unloading, storage, and feed facility was placed in operation in 2006.

Process Description

The Chemical Building serves as the central storage and dosing facility for ferric chloride and waste pickle liquor. The function of this facility is to add metal salts to the plant processes for various uses, including phosphorus removal, odor control, and as a settling aid. The Chemical Building has nine storage tanks, each with a nominal capacity of 76,000 gallons. Total storage capacity is 684,000 gallons. Sixteen chemical feed pump systems are provided for dosing of waste pickle liquor and/or ferric chloride in the plant Influent, Primary Treatment, Secondary Treatment, Nitrification, and Solids Processing blend tanks. The metal salt systems are monitored by PCS.

Evaluation

The metal salts systems were recently installed and provide for adequate chemical storage and delivery for all plant needs. The metal salt systems could be used for a wet weather treatment system with

Blue Plains Process Evaluation

modifications and new piping to deliver the chemical to a new facility.

2.3.17 Plant-wide Chemical Systems - Dry Polymer System

Historical Background

A new centralized plant-wide dry polymer unloading, storage, batching and feed facility was placed in operation in 2006.

Process Description

Six dry polymer storage and batching systems provide polymer for all plant needs. Systems 1, 2, and 3, rated at 8400 dry pounds per day, are dedicated to the plant's solids processes and Systems 4, 5, and 6, rated at 4100 dry pounds per day to the plant's liquid treatment processes. The Polymer batches are normally mixed to a concentration of 0.25 % to 0.50 %. Each polymer system includes batching and aging tanks and demand tanks. Chemical feed pumps deliver the polymer to the treatment processes, paced by an automated system. The dry chemical systems are monitored by PCS.

Evaluation

The dry polymer systems were recently installed and provide for adequate polymers for all plant needs. The systems could be used for a wet weather treatment system with modifications and new piping to deliver the appropriate polymer to a new facility.

2.4 SUMMARY OF PROCESS EVALUATIONS

Significant upgrades to facilities throughout Blue Plains have been constructed under the Capital Improvement Program to assure continued compliance with WASA's current permit. As previously identified, the plant does not have the sedimentation capacity in the primary treatment, secondary treatment, and nitrification/denitrification processes to meet the proposed total nitrogen permit limit. The existing nitrification/denitrification reactors only have sufficient capacity to meet the current TN goal of 7.5 mg/l on an annual average basis and at the current peak flow limitation of 511 mgd. Various options are available to provide added reactor capacity and these options are discussed in Section 2.5

Various strategies have been identified to address the shortfall in sedimentation capacity. The first strategy is to build additional sedimentation tanks or basins to handle peak flows. The second strategy is to reduce the peak flow rates to the existing facilities and provide alternate treatment systems for the peak flows that are off-loaded from the existing facilities. These peak flow rate reduction strategies are summarized as follows:

- Reduce peak hydraulic loading rate on primary sedimentation basins to prevent high concentrations of solids and other material from overloading the secondary treatment system. The prior evaluations indicate that the peak rate must be reduced from 1,076 mgd to 740 mgd. Any further reduction below 740 mgd will have an incremental, positive impact on primary treatment performance.
- Reduce peak hydraulic loading rate on secondary sedimentation basins to ensure a consistent total suspended solids concentration in the secondary effluent that is no greater than 20 mg/l. This could be done by reducing the peak factor to the biological processes from 2.0 (740 mgd) to 1.5 (555 mgd) to match the capacity of the sedimentation basins.
- Reduce peak hydraulic loading rate on nitrification/denitrification sedimentation basins to ensure that the basins are not overloaded during storm events. Separate treatment of the spent washwater recycle could be provided to further reduce the peak loading rate.

2.5 NITROGEN REMOVAL ALTERNATIVES

2.5.1 Enhanced Clarification Facility

The performance of the East Primary facilities is not acceptable at plant influent rates over 740 mgd for enhanced nutrient removal. As noted in Table 2-6, the overflow rate at 1076 mgd is greater than 3,600 gpd/sf. The LTCP recommended four additional primary sedimentation tanks to handle the peak wet weather flows. There is only space available for 4 additional tanks. However, the LTCP was developed and finalized in July 2002, before the annual mass load limit for Blue Plains was established. The LTCP recommended plan recognizes that the proposed excess flow improvements do not address the impacts of the plan on nitrogen removal at Blue Plains. Adding four primary sedimentation tanks would reduce peak overflow rates to 3,000 gpd/sf, which is not sufficiently low to achieve the required target performance for increased nitrogen removal.

The space available for 4 primary sedimentation tanks could alternately be used to build a separate wet weather treatment facility, using an Enhanced Clarification Facility (ECF). Figure 2-9 shows how the ECF would be incorporated into the process flow diagram. There are several proprietary high-rate sedimentation technologies that employ the ballasted flocculation process that provide substantially better solids removal than primary treatment at significantly higher loading rates. The Actiflo and Densadeg processes are two of these technologies that could be used for the ECF. These technologies are further defined in Appendix D Wet Weather Treatment. Space is available to provide approximately 500 mgd of wet weather treatment in the space allotted for the 4 primary sedimentation tanks. The new facility would also include improvement of the flow distribution from the grit chambers to the east process, i.e., the existing primary sedimentation basins and the new enhanced clarification facility. The comparative performance the primary sedimentation tanks and ECF at various loading rates are shown in Table 2-9. Construction of an ECF is necessary to off-load excess flow from the existing East Primary facilities for enhanced nutrient removal. This is needed to provide a suitable primary effluent that does not overload the secondary treatment process.

Blue Plains Process Evaluation

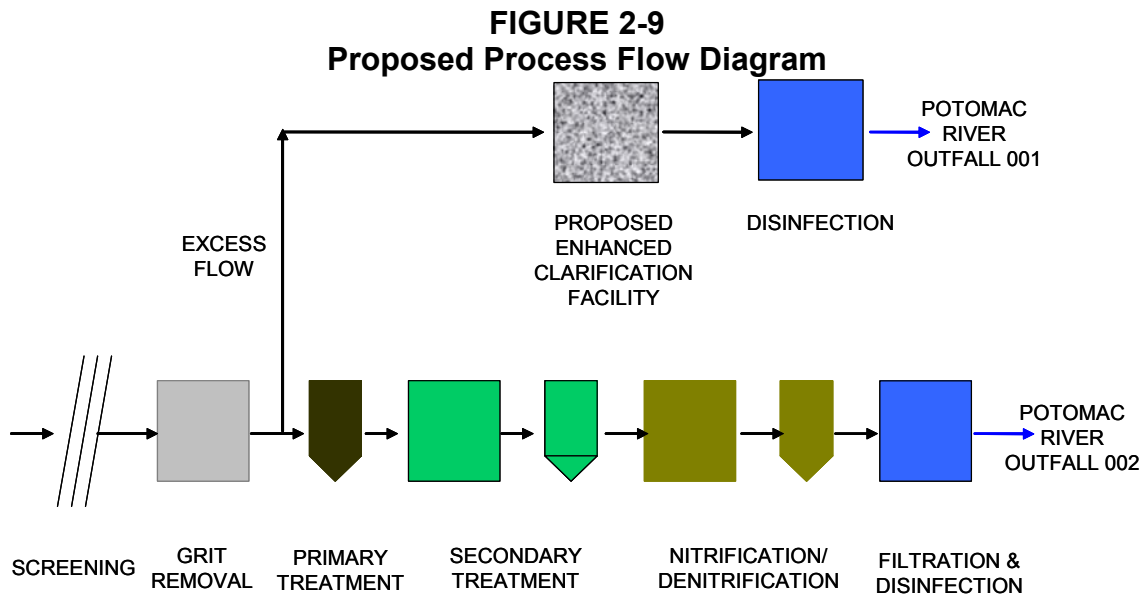

**Table 2-9
Expected Removal Efficiencies of Primary Sedimentation Basins at
Peak Influent Flow = 1,076 mgd**

	Flow (mgd)	Surface Overflow Rate (gpd/ft ²)	TSS (% Removal)	BOD (% Removal)
West Primary PSTs	296	2,240	50	32
East Process (existing and with 4 new tanks, with one tank out of service)				
Existing 20 PSTs	780	3,630	10	<10
Proposed 24 PSTs	780	3,000	22	10
East Process with ECF				
Existing PSTs	444	2,070	50	32
ECF		56,800-61,100 ¹	70-94 ²	35-96 ²

¹The SOR is approximate and is based on typical design criteria provided by the manufacturers and used to size facilities that are currently in operation. Loading rates are per unit and number of units can increase based on total size of facility required.

²The range of removal rates were obtained from case studies of pilot tests done by others with addition of ferric chloride and polymer.

In addition to the need for an enhanced clarification facility as part of the improvements necessary to increase nitrogen removal at Blue Plains, an enhanced clarification facility would provide improved effluent quality for excess flow discharged from Outfall 001. This facility could also provide treatment for the flow stored in the combined sewer overflow tunnel. As evident from the range of performance reported in various pilot tests by others (Table 2-9), pilot tests at Blue Plains would be prudent to confirm the design criteria and expected effluent quality from an enhanced clarification facility.

Blue Plains Process Evaluation

An area of specific interest regarding impact on water quality is the impact that the enhanced clarification system would have on pathogens in the treated excess flow that is discharged through Outfall 001. The proposed enhanced clarification process impacts pathogen removal in two ways. The first is that enhanced clarification removes pathogens and particulates from wastewater. The second is that enhanced clarification reduces turbidity and disinfectant-consuming constituents thereby increasing the effectiveness of subsequent disinfection.

The enhanced clarification process uses coagulant and polymer to form a floc followed by introduction of ballast (typically sand or sludge) that attaches to the floc to accelerate settling. The settled solids and consequently, the pathogens that adhere to the floc are removed from the wastewater flow. Larger microorganisms such as protozoan, bacteria, and algae (measured in micrometers) would be easily captured as the floc forms and settles. Although viruses are very small (measured in nanometers) some may also be captured during the floc formation and settling. It is important to note that all the microorganisms mentioned above tend to clump together or attach to suspended solids in the environment. Therefore microbes that are associated with particulates would settle out as well. Protozoa, such as *Cryptosporidium* have been found to be removed up to 4 logs (99.99 percent) through enhanced clarification ballasted flocculation (City of Melbourne Ballasted Flocculation and Clarification Study: Gutshall 1999).

Most of the solids particles that can harbor microorganisms, block ultraviolet light, and consume oxidizing chemicals such as chlorine are removed during the ballasted flocculation process (Radick 2001). Sodium hypochlorite is used for disinfection of the effluent at the Advanced Wastewater Treatment Plant at Blue Plains. Pilot studies done by others indicated that the quality of the ballasted settling effluent is typically relatively easy to disinfect regardless of the subsequent disinfection method.

Chemical disinfectants inactivate microorganisms by destroying or damaging cellular structures, interfering with metabolism, and hindering biosynthesis and growth (Snowball & Horsnsey 1988, Brock 1994). Free chlorine rapidly inactivates bacteria, viruses, and some protozoan cysts, with the exception of *Cryptosporidium* and *Giardia*, at low concentrations. In addition to pH and temperature, the efficacy of chlorination is primarily dependant on turbidity, and the types of microorganism's present (Gerba, Nwachuku & Riley 2003).

Organisms that would be removed by the enhanced clarification process prior to disinfection are also the organisms most resistant to chlorine. These include the protozoan cysts (*Cryptosporidium* and *Giardia*), the spore forming bacterium (*Bacillus subtilis*), and bacterium with thick waxy outer cell walls (*Mycobacterium* species). The resistance of these microorganisms to disinfection is due to the exterior structures they produce to survive environmental conditions. These organisms of concern, resistant to chlorine, have generally been removed during the enhanced clarification process.

2.5.2 Reduce Hydraulic Load on Sedimentation Basins in the Biological Systems

As described above, the secondary sedimentation basins are hydraulically overloaded during wet weather events. The Ten State Standards recommends a maximum surface overflow rate (SOR) of 1,200 gallons per day per square foot of sedimentation basin surface area (gpd/sf) for secondary treatment and 800 gpd/sf for nitrification systems. This is consistent with operating experience at Blue Plains that the solids in the nitrification/denitrification system have more trouble settling than those in the secondary system. Table 2-10- shows the area of each sedimentation basin and the computed value of the maximum flow for the each process based on available area and the Ten State Standards recommended SOR. Computation of the system capacity assumes that one basin in each process is out-of-service for maintenance purposes, either preventive or corrective. Each dual purpose basin provides approximately 30 mgd of additional flow that can be treated in the secondary process or approximately 20 mgd of additional flow that can be

Blue Plains Process Evaluation

treated in the nitrification-denitrification process. The basins were designed to serve either process so that they could be used for redundancy in case of process upset, equipment failure or construction. However, it is evident from the recommended maximum recommended flow that they should be in service to the nitrification/denitrification system under normal conditions to balance the capacity of the secondary system with the nitrification/denitrification system. Alternatives to reduce the hydraulic load on each process are to limit the peak flows to the existing capacity of the systems or to provide additional sedimentation basins.

Table 2-10
Maximum Recommended Flow Based on Hydraulic Load

	# of basins/ # in service	Area per Basin (sf)	Total Available Area (sf)	Maximum Recommended Flow (mgd)
Secondary Treatment				
West Secondary Basins	12/11	19,875	218,625	262
East Secondary Basins	12/11	20,670	227,370	272
Total Secondary Basins				534
Nitrification/Denitrification Treatment				
Nitrification/Denitrification Basins – Odd side	14/13	19,118	248,534	199
Nitrification/Denitrification Basins – Odd side	14/13	19,118	248,534	199
Total Nitrification/Denitrification Basins				398
Dual Purpose Basins in Service to Nitrification/Denitrification Treatment				
Dual Purpose Basins	8/7	24,645	172,515	140
Total Nitrification/Denitrification Basins including Dual Purpose				538

Reduce 4-hour Peaking Factor

As previously discussed, wet weather flows negatively impact TN removal due to limiting the capacity of nitrification in the Nitrification/Denitrification process. The limitation results from switching some of the stages and entire reactors to solids holding zones. In addition, switching back the reactors to normal operation, i.e. recovery period, is directly related to the magnitude and duration of the plant influent flows through complete treatment. Reducing the plant influent 4-hour peaking flow from 740 MGD (peaking factor=2.0) to 555 MGD (peaking factor=1.5) provides for more on-line process reactor capacity during wet weather, a more stable operation, and a quicker recovery period, which results in significant reduction in the total TN load to the river during a wet weather event. The wet weather flow that is removed from the biological processes, flow at influent rates greater than 555 mgd, up to 740 mgd, would be treated in the enhanced clarification facility.

Provide Additional Sedimentation Basins

To meet the proposed TN discharge limit and to treat a 740 mgd 4-hour peak flow rate through the biological processes, additional sedimentation basins will be required. An additional 200 mgd of sedimentation basin capacity will be required for each of the biological systems. For the secondary system, approximately 172,000 square feet of available surface area would be required. This is equivalent to the existing 8 dual purpose sedimentation basins. As seen on the site plan presented in Section 1, there is limited space available to construct any land-intensive upgrades. Abandoned anaerobic digesters could be demolished and the new basins could be constructed in that area on the northwest side of the site. These new sedimentation basins will require significant piping to convey the flow from the secondary

reactors to the new sedimentation basins as well as to convey the return sludge to the secondary reactors.

Likewise, an additional 200 mgd of hydraulic capacity is required for the nitrification/denitrification system. Another set of sedimentation basins, equivalent in surface area to the odd-side (or even-side) nitrification/denitrification reactors, would provide the required capacity. However, any land available close to that process may be required to expand the existing biological reactors to increase nitrogen removal. Therefore, the new sedimentation basins will need to be constructed on top of the existing sedimentation basins.

2.5.3 Improve Biological Nitrogen Removal System

The existing nitrogen removal system will need to be expanded or augmented to consistently and reliably meet the proposed nitrogen discharge limit under all conditions. Several alternative methods to achieve greater reductions in total nitrogen were investigated.

Development and Screening of Nitrogen Removal Technologies

Several technologies that could provide reliable enhanced nutrient removal were evaluated during the strategic process engineering planning process. Several additional technologies have been identified that could provide more effective and more cost efficient treatment were identified as the planning process has evolved. The following technologies were considered for application to Blue Plains:

- Two sludge Nitrification/Denitrification (existing process)
- Single sludge ENR
- Deep Bed Denitrification Filters
- Biologically Active Filters (BAF)
- Moving Bed Bioreactors (MBBR)

A brief description and evaluation of these technologies follows.

Two sludge Nitrification/Denitrification (existing process)

The existing process configuration, described in Section 2.1, is a two-sludge system which means that there are two activated sludge systems arranged in series. The first system is the Secondary Treatment process, which removes carbonaceous organic material, followed by Nitrification/Denitrification, which first converts organic and ammonia nitrogen into nitrate nitrogen and then, with methanol addition, converts the nitrate nitrogen into nitrogen gas that is released to the atmosphere. Both of these processes use different microorganisms to provide the required treatment.

The existing process was piloted in 1998, using one half of the Nitrification Facilities. This was accomplished by constructing a methanol feed system to dose methanol into Stage 4 of the existing 5-stage reactors. The microorganisms in denitrification process utilize methanol as a food source in an anoxic environment to convert nitrate nitrogen into nitrogen gas. The half-plant scale process was successful and WASA converted the other half of the reactors to operate in the dual nitrification and denitrification mode in 2000. The performance of the existing process since full-scale denitrification was started up in 2000 is described in Section 2.3.6 and shown in Figure 2-7. The process has performed well and has met the permit goal of 7.5 mg/l in each of the years after startup of the full-scale facility in 2000.

The capability of the existing process facilities to reliably meet an ENR permit requirement of 4.2 mg/l is limited by both control systems and reactor capacity. Prior to denitrification, all five stages were dedicated to nitrification, as was the original plant design. Converting Stages 4 and 5 of each reactor to denitrification reduced the capacity of the reactors to nitrify the wastewater by 40 percent. This is not critical in the summer months with warm wastewater temperatures when complete nitrification takes

Blue Plains Process Evaluation

place in Stages 1 and 2. It is critical in the coldest months when the rates of both nitrification and denitrification processes slow down and each process requires more reactor volume. The plant turns off methanol feed in the coldest months to obtain as much nitrification as possible to meet the permit limits for ammonia nitrogen.

The existing process has performed sufficiently well to consider it as a possible technology for ENR. This technology option would require adding more reactors to meet the permit limit.

Single-Sludge ENR

The two-sludge system currently used at Blue Plains could be converted to a single-sludge system. This could be done by using all of the secondary treatment process reactors for the West Process flows and all of the nitrification reactors for the East Process flows. The Secondary Treatment reactors have a volume of 27.825 million gallons and the Nitrification/Denitrification reactors have a volume of 55.25 million gallons, for a combined volume of 83.03 million gallons. This volume would provide a hydraulic retention time of 5.39 hours if used in a single-sludge configuration. By converting the plant to a single sludge system, the loading rate on the sedimentation basins would be significantly reduced.

Single sludge systems can be designed to reliably meet an effluent TN limit of 4.2 mg/l, provided adequate reactor volume is available. As an example, the WSSC Piscataway wastewater treatment plant, which has a step-feed single sludge system with a hydraulic retention time of approximately 12 hours has been producing an effluent TN of just less than 3 mg/l. A single sludge ENR system for Blue Plains designed to meet an effluent TN permit limit of 4.2 would require an estimated 10 to 12 hour hydraulic retention time. This would require an approximate doubling of the existing reactor capacity, which would be difficult to implement with the available space at Blue Plains. For this reason, conversion of the existing two-sludge system to a single sludge system is not carried forward.

Deep Bed Denitrification Filters

Prior evaluations of technologies applicable to Blue Plains upgrade to limit of technology for nitrogen removal have included deep bed denitrification filters. Deep bed denitrification filters have been used in many installations for nitrate removal. The denitrification filter used most commonly is a proprietary process of TETRA Technologies; however similar technologies are available from Leopold and US Filter. The filters provide both suspended solids removal and denitrification by microbial growth on the filter media. Sand is the filter packing and the size selected is small enough to provide effective filtration and sufficient surface area for microbial growth but large enough to accommodate solids capture without excessive headloss. Effluent TSS concentrations of less than 5.0 mg/L are commonly achieved.

The Deep bed denitrification filter process is generally similar for the three major vendors in the market today, but the specific designs and type of filter media vary somewhat depending on the manufacturer. In general, the influent is evenly distributed over weirs as it flows downward by gravity through the filter bed. The general operation of the deep bed denitrification filter process is overall very similar to the plant's existing effluent filter system.

This option would not require expansion of the existing BNR reactors, but would be located downstream of the Nitrification/Denitrification sedimentation basins. To achieve an effluent TN concentration of 4.2 mg/l, the deep bed filters would be sized for a hydraulic loading rate of approximately 2 gpm/sf, at the peak flow rate. The existing effluent filters have a hydraulic loading rate of 3.5 gpm/sf, at the average daily flow rate and 7 gpm/sf at peak rate. This technology could be implemented by retrofitting the existing effluent filters to deep bed filters however significant additional deep bed filter capacity would be required. The cost of this option is not competitive with the newer high rate technologies available and is not carried forward.

Biological Anoxic Flooded Filters (BAF)

Biological Anoxic Flooded Filters (BAF) is a newer, high-rate technology that could be used for ENR. This option would not require expansion of the existing BNR reactors, but would be located downstream of the Nitrification/Denitrification sedimentation basins. Effluent from the sedimentation basins would be dosed with methanol and fed to the BAF process. The process would be sized to remove the nitrate nitrogen remaining in the BNR effluent. There are two up-flow submerged attached growth processes that are available and have been used for post-anoxic nitrate removal. These systems are the Infilco Degremont Biofor™ filter and the Kruger BioStyr filter. Both of the processes are high rate processes, compared with deep bed filters, which provides a clear cost advantage for the BAF technology. The general operation of the BAF process is similar to the plant's existing effluent filter system and the filters require periodic backwashing to remove accumulated solids. This technology was piloted in Baltimore and provided a high level of nitrogen removal and stable operation at cold temperatures. This technology is considered a possible technology to carry forward for ENR because of its performance and it is a high rate process which minimizes space required and capital cost. This technology option would require piloting to obtain design criteria and confirm its applicability.

Moving Bed Biofilm Reactors (MBBR)

Moving Bed Biofilm Reactors (MBBR) is a newer, high-rate technology that could be used for ENR. This option would not require expansion of the existing BNR reactors, but would be located downstream of the Nitrification/Denitrification sedimentation basins. Effluent from the sedimentation basins would be dosed with methanol and fed to the MBBR process. The process would be sized to remove the nitrate nitrogen remaining in the BNR effluent. The MBBR technology is a flow-through, attached growth (also called fixed film) process that has been used for ENR, particularly in the Scandinavian countries. These systems are offered by Anox Kaldnes and Infilco Degremont, among others. MBBR is a high rate processes, compared with deep bed filters, which provides a clear cost advantage for the MBBR technology. The MBBR process uses reactors partially filled with plastic media. Mixers are used to continuously suspend the media to provide maximum contact with the wastewater as it flows through the reactor. Unlike filtration processes, an MBBR does not require periodic backwashing to remove accumulated solids. The solids that are produced are continuously sloughed off the media. This technology was piloted at the Noman Cole Pollution Control Plant in Fairfax County and provided a high level of nitrogen removal and stable operation at cold temperatures. This technology is considered a possible technology to carry forward for ENR because of its performance and it is a high rate process which minimizes space required and capital cost. This technology option would require piloting to obtain design criteria and confirm its applicability.

Another application of the MBBR technology would be to use MBBR reactors to both nitrify and denitrify the West Process secondary effluent. This application would be configured similar to the existing BNR reactors with an aerobic zone for nitrification and an anoxic zone for denitrification. The effluent from the reactor would be routed to the Nitrification/Denitrification sedimentation basins. The existing Nitrification/Denitrification reactors would be devoted to the East Process secondary effluent. This technology option would also require piloting to obtain design criteria and confirm its applicability.

Results of Initial Screening of Nitrogen Removal Technologies

Three technologies are carried forward for further evaluation, the existing Nitrification/Denitrification process, BAF filters, and MBBR. The existing nitrification/denitrification suspended growth reactor process is used in the TN/Wet Weather alternatives development because WASA has detailed operating experience with this technology and it has been operated successfully at Blue Plains. A significant amount of operating data is available for this process which could be used for process modeling. Process modeling was performed for the existing plant process with and without additional reactors to determine the number of additional reactors that would be required to reliably achieve an annual average effluent

Blue Plains Process Evaluation

TN concentration of 4.2 mg/l. The other two technologies would require piloting to establish reliable process sizing criteria. WASA intends to conduct piloting of the fixed film technologies as an option to building additional nitrification/denitrification suspended growth reactors. As previously indicated, the fixed film technologies are expected to provide more stable and higher TN removal performance at cold temperatures than an expansion of the existing suspended growth process. This piloting is expected to be performed over a 9-month period, starting in the fall of 2007. It is necessary to carry the piloting through the cold weather period of January through March to obtain worst case performance data and then into the summer to determine seasonal performance changes.

Process Modeling Results

WASA has developed a calibrated process model that was used as a tool, among others, to estimate the total nitrogen discharge with and without augmentation to the existing process. The model was run for each month of the year using the minimum of the three average monthly temperatures for the years 2002-2004. The average monthly temperatures used are shown in Figure 2-10. The model was first run for the “existing system”, which included the ongoing improvements to the nitrification/denitrification system and return of the anaerobic digester centrate to the reactors. For the design condition of maximum month flow and load and a temperature of 12°C, which is the coldest month, the model predicted an effluent TN concentration of 10 mg/L and an annual average concentration over 7.5 mg/l. Another scenario was modeled that included a separate treatment system to treat the high ammonia centrate recycle flow. The predicted effluent nitrogen in this case was the same as in the first case because the inert solids have a negative effect on the process performance of the main plant.

The model was used to project performance with additional nitrification/denitrification reactors. The model was run under the same conditions described above (i.e., maximum month flows and loads and minimum month temperature) and four additional process reactors and some seeding efficiency was assumed for the separate centrate treatment recycle. For the worst month conditions, the model predicted an effluent TN of 3.5 mg/l. Additional model runs were done with average flows and loads and varying seasonal temperatures to predict an annual TN effluent. The predicted monthly nitrogen concentrations are shown on Figure 2-11 and the corresponding annual average TN is 2.7 mg/l. The model does have areas of uncertainty. For example, the monthly average values are steady state and do not reflect wet weather events that can have an impact on effluent TN for several days after the event. In addition, precise values for kinetic parameters for the anoxic methanol utilizing organisms in low temperatures as well as growth and decay rates are not available, but have been estimated based on experience. WASA is participating in research to contribute to the available knowledge in this area as well as other relevant topics related to nitrogen removal. For this reason and the impact of wet weather events on process performance, the number of additional nitrification/denitrification reactors was increased from 4 to 6 for an annual average TN of 4.2 mg/l.

Blue Plains Process Evaluation

FIGURE 2-10

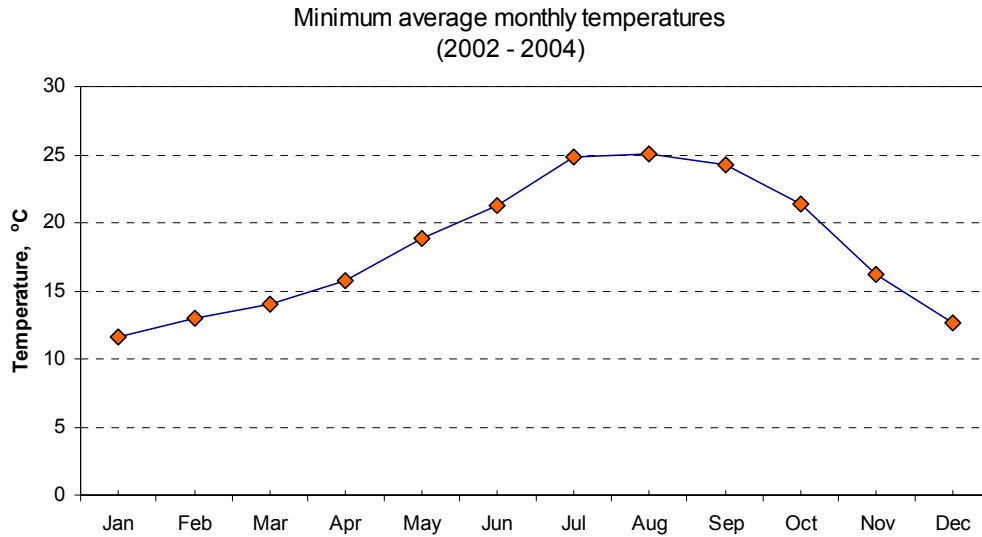
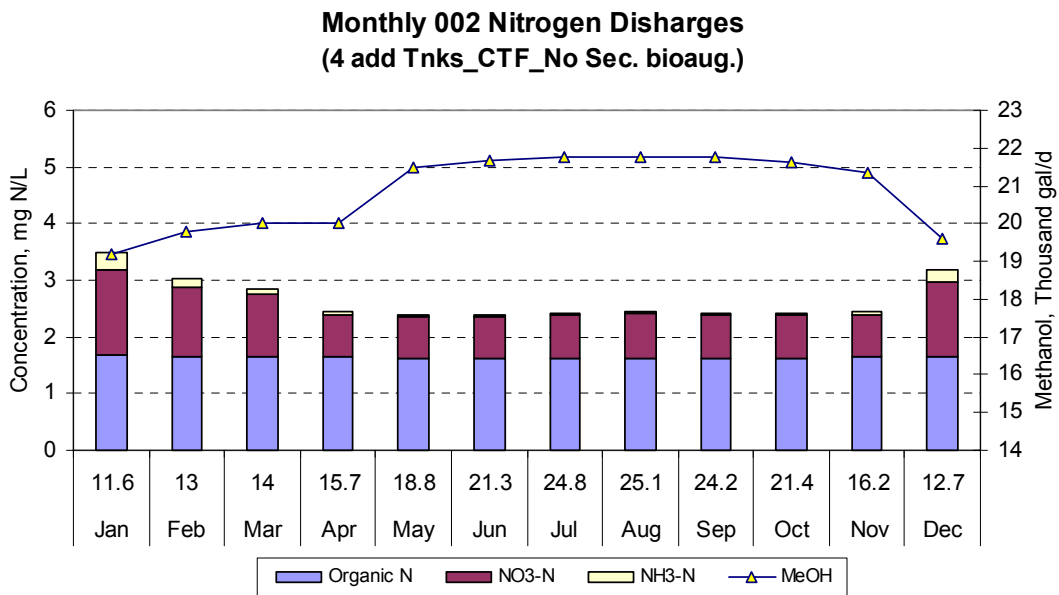

FIGURE 2-11



Collection System and Receiving Water Evaluation

Section 3 Collection System and Receiving Water Evaluation

3.1 INTRODUCTION

This section describes the methodology used to predict the flows to be treated by Blue Plains, CSO overflows to the receiving waters, and the impact of various alternatives on receiving water quality and compliance with water quality standards. The same procedures used develop and evaluate the LTCP were used to analyze the TN/WW plan. These are summarized in the following sections.

3.2 RAINFALL CONDITIONS

EPA's 1994 CSO Control Policy (1994) requires the effectiveness of CSO controls to be evaluated on a "system-wide, annual average basis." Identification of annual average rainfall conditions is thus a fundamental step in the LTCP process. As part of the development of the LTCP, the rainfall in the years 1988, 1989 and 1990 was selected as the average year period, which is the basis for CSO planning. This same period was selected by the D.C. Department of the Environment (formerly Department of Health) and the EPA for development of TMDLs in the District. For the TN/WW Plan evaluations, the rainfall in the years 1988, 1989 and 1990 was used to perform the evaluations.

Table 3-1 compares the rainfall in the years 1988, 1989 and 1990 to the long term average rainfall in the District.

**Table 3-1
Annual Average Rainfall Conditions in the District**

<i>Statistic</i>	<i>1988</i>	<i>1989</i>	<i>1990</i>	<i>Average of 1988-1990</i>	<i>Long Term Average¹</i>
Annual Rainfall (inches)	31.74	50.32	40.84	40.97	38.95
No. Events > 0.05 inches ²	61	79	74	71	74
Average Storm Duration (Hours) ²	9.6	11.2	9.6	10.1	9.9
Average Maximum Intensity (in/hr)	0.15	0.18	0.15	0.16	0.15
Maximum Intensity (in/hr)	1.32	1.31	1.25	1.29	1.30
Percentile ³	14th	90th	68th	68th	

- Notes:
1. Ronald Reagan National Airport hourly data, 1949-1998
 2. Individual events separated by a minimum of 6 hours with no rain. A threshold of 0.05" was selected since rainfall less than this produces minimal, if any, runoff.
 3. Percentile is based on total annual rainfall.

3.3 COLLECTION SYSTEM CHARACTERIZATION

3.3.1 Combined/Sanitary Sewer System Model

As part of the development of the LTCP, the Danish Hydraulic Institute's (DHI's) MOUSE model was selected as the tool for characterization and evaluation of the CSS. It contains components that replicate the generation of runoff across urban watersheds, and the transport of both runoff and sanitary flow through sewers. The model was calibrated based on flow monitoring and sampling conducted from August 1999 to August 2000. After calibration, the model was used to make the evaluations used to develop the LTCP.

Since the original model was developed, DHI has upgraded the MOUSE model. The latest version of the model, MIKE URBAN, was used to perform the TN/WW plan evaluations. In addition, since the original model was developed, changes have been made to the sewer system and additional data have become available on the characteristics of the drainage areas. The following changes were made to improve the model:

Collection System and Receiving Water Evaluation

- System Changes – While the firm capacity of the pumping stations has not changed, the sizing of the individual pumps at the stations has been changed as a result of the pumping station rehabilitations currently underway. The changes in the stations as a result of the rehabilitations were incorporated in the model. Examples of changes include the following:
 - For Main Pumping Station, the original pump configuration included 2-60 mgd pumps, and 80 mgd pump and a 100 mgd pump. After rehabilitation, the station will include 3-90 mgd pumps and 1-60 mgd pump.
 - At Eastside Pumping Station, revised pump start/stop and pump curves were incorporated corresponding to the new pumping equipment installed.
 - The diversion structures for CSOs 005, 007, 014, 015, 020, 023/024, and 027 were modified/reconstructed as part of the Three-party Consent Decree to reduce dry weather overflows. The revised diversion structures were included in the upgraded model.

- Characterization of Suburban Flows – In the LTCP, regression relationships were developed relating wet weather volume, peak flow, lag time and duration of wet weather events to rainfall in the District for each suburban point of connection to D.C. The relationships were based on 1999-2000 WASA supervisory control and data acquisition (SCADA) flow data. Since the development of the LTCP, significantly more flow data for each jurisdiction has become available. In addition, it was desirable to improve the wet weather relationships to better represent peak flow. As a result, suburban wet weather relationships were improved using the following approach:
 - WASA SCADA data from 1998 to 2005 for all suburban points of connection to D.C. was obtained and reviewed.
 - Rainfall for each drainage area was plotted against wet weather volume. The ‘x’ axis intercept of the plot indicates the amount of depression storage in the system which is the amount of rainfall needed to cause a wet weather response. The slope of line represents the effective impervious area of the basin.
 - Once the effective impervious area was determined, the wet weather response of each suburban area was simulated using the MOUSE model. Rainfall data from Dulles Airport, National Airport and Beltsville were used in conjunction with the effective impervious area for each basin. Runoff parameters in MOUSE were modified to produce the magnitude, shape and lag of the wet weather response observed in the SCADA data.

The new relationships predict the timing, volume and peak flow rate of the suburban wet weather response better than the LTCP relationships. The new relationships were then applied using the 1988-1990 rainfall data to produce the suburban flows for each storm in the evaluation period.

- Characterization of Flows from the Separate Sanitary Area in D.C. – As part of the sewer system assessment program, flow meters were installed in the separate sanitary area to better characterize the wet weather response from separate sewer areas in D.C. Updated relationships based on the new flow data were used in the modeling.

- Updated Drainage Area Characteristics – When the LTCP was developed, GIS coverages of the District and the sewer pipes were not available. The GIS coverages that are now available were used to update the delineation of the sewer shed boundaries and the hydrologic characteristics of the drainage areas such as imperviousness and slope.

Figure 3-1 shows the overall model structure.

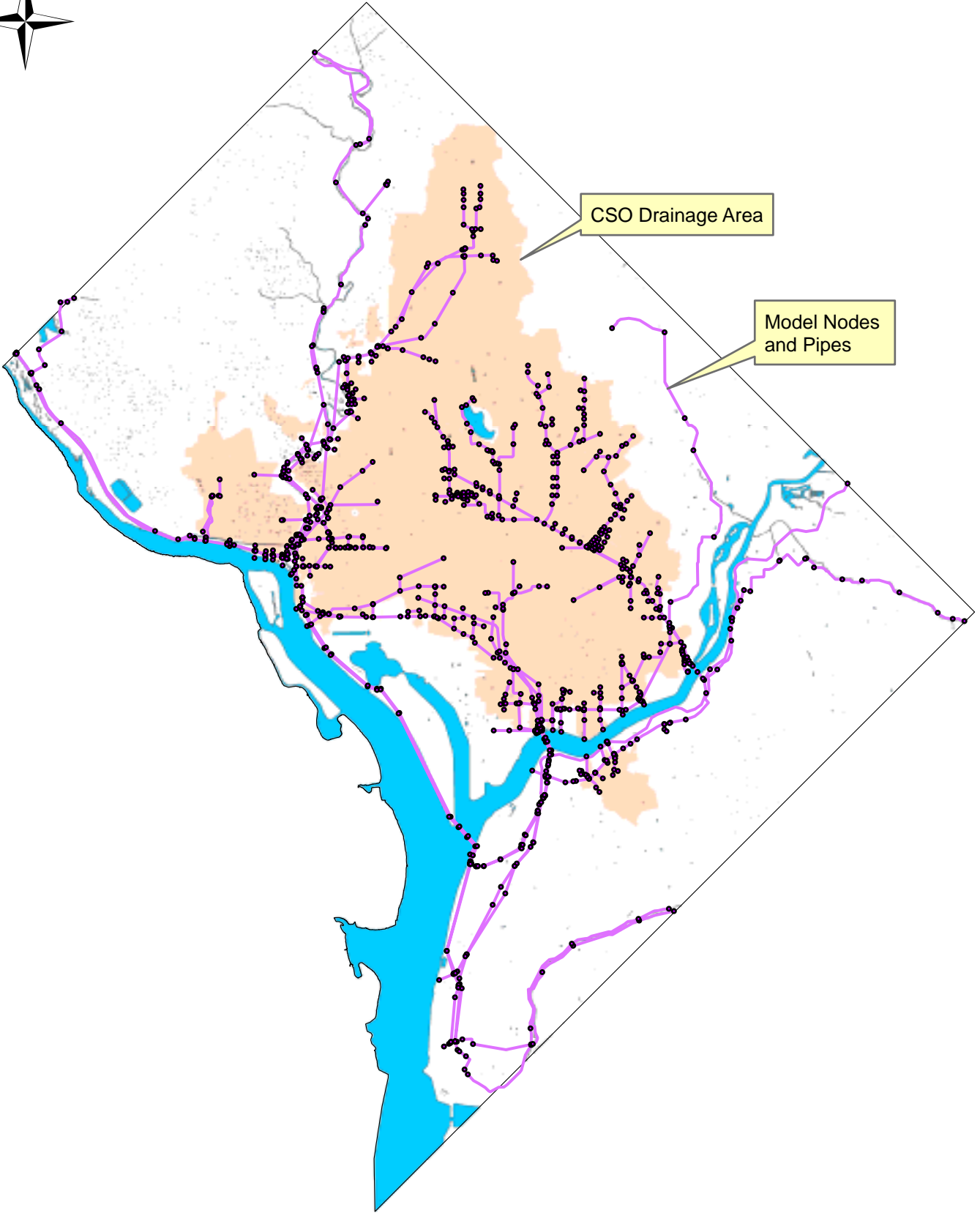

Collection System and Receiving Water Evaluation

As was done for the LTCP, the model was run for every storm in the three year period 1988-1990. Model results were post-processed to output information on the frequency of CSOs, overflow volume and other parameters. For Blue Plains flows, model results were output on an hourly basis for the entire three year period to identify plant influent flows.

3.3.2 Separate Storm Water System Model

The separate storm water system in the District imparts significant loads on the receiving waters during rain events. A model of the separate storm water system was developed during preparation of the LTCP. The same model output used to develop the LTCP was used to perform the TN/WW Plan evaluations. No changes to storm water loads were made.

3.3.3 Event Mean Concentrations

Event mean concentrations (EMCs) were used to calculate pollutant loads from the CSS, SSWS, and Blue Plains. EMCs for CSO and the separate storm water discharges were developed during preparation of the LTCP based on sampling conducted during the LTCP.

EMCs are defined as the total mass of pollutants discharged divided by the total flow volume. EMCs for each monitored storm were calculated by computing a flow weighted average concentration of all the samples that were taken during the storm. In addition, overall EMCs for each site were calculated by computing flow weighted averages over all the monitored storm events.

The EMCs used for CSO and the separate storm water system are identical to those used for the LTCP, as summarized in Table 3-2. The EMCs used for Blue Plains Outfalls 001 and 002 are discussed in the section on the evaluation of alternatives.

To generate loads to the receiving waters, EMCs were multiplied by the modeled overflow volume from the CSS and the modeled flow volumes from the SSWS and Blue Plains effluent. The resulting pollutant loads served as inputs to the receiving water models.

**Table 3-2
Event Mean Concentrations for CSO and Separate Storm Water**

Parameter	Units	Anacostia CSOs					Potomac and Rock Creek CSOs	Separate Storm Water System
		B St./NJ Ave. (CSO 009, 010, 011, 011a)	Tiber Creek (CSO 012)	NEB Swirl Effluent (CSO 019)	NEB Swirl Bypass (CSO 019)	All Other Anacostia CSOs		
CBOD ₅ , Total	mg/L	51	74	39	34	53	36	19
CBOD ₅ , Dissolved	mg/L	7	15	12	9	10	11	15
Chemical oxygen demand	mg/L	110	161	135	143	138	107	73
Dissolved Organic Carbon	mg/L	9	24	12	10	15		16
Total Suspended Solids	mg/L	147	186	118	182	171	130	94
Volatile Suspended Solids	mg/L	77	81	48	58	72	0	18
Ammonia-as N	mg/L	2.90	0.66	0.69	0.46	1.34	0.96	0.84
Nitrate+Nitrate-as N	mg/L	0.60	0.81	0.79	0.78	0.73	0.85	0.94
Total Kjeldahl Nitrogen	mg/L	6.0	4.0	4.0	2.4	4.1	3.8	2.2
Organic Nitrogen	mg/L	3.1	3.34	3.31	1.94	2.76	2.84	1.36
Total Organic Carbon	mg/L	14	30	16	12	19	0	19

Collection System and Receiving Water Evaluation

Parameter	Units	Anacostia CSOs					Potomac and Rock Creek CSOs	Separate Storm Water System
		B St./NJ Ave. (CSO 009, 010, 011, 011a)	Tiber Creek (CSO 012)	NEB Swirl Effluent (CSO 019)	NEB Swirl Bypass (CSO 019)	All Other Anacostia CSOs		
Total Phosphorus	mg/L	1.31	0.98	0.85	0.83	1.04	1.04	0.44
Ortho Phosphorus (dissolved)	mg/L	0.37	0.11	0.23	0.15	0.21	0.22	0.22
Hardness	mg/L	85	71	43	40	66	37	56
Fecal Coliform	MPN/100 ml	939,270	939,270	191,309	939,270	939,270	939,270	28,265
E. Coli	MPN/100 ml	686,429	686,429	122,011	686,429	686,429	686,429	16,238
Dissolved Oxygen	mg/L	6	6	6	6	6	6	6
Organic Phosphorus	mg/L	0.94	0.87	0.62	0.68	0.83	0.82	0.22

3.4 RECEIVING WATER CHARACTERIZATION

A receiving water monitoring and modeling program for the Anacostia River, Potomac River, and Rock Creek was conducted as part of the development of the LTCP. The same calibrated models used to develop the LTCP were used to assess the water quality impact of the TN/WW program. The models are briefly summarized below:

- **Potomac River Model** - The Potomac River was modeled using EPA's Dynamic Estuary Model, or DEM. DEM is a one-dimensional model that consists of a hydrodynamic model (DYNHYD) that simulates water movement, and a water quality model (DYNQUAL) that simulates mass transport and the water quality. DEM encompasses the entire length of the tidal Potomac River from the head of tide at Chain Bridge in DC to the mouth of the Potomac at its confluence with the Chesapeake Bay.
- **Anacostia River Model** - The Anacostia River was modeled using a hybrid model incorporating features of the Tidal Anacostia Model (TAM) developed by COG and refined by LTI, and EPA's WASP or Water Quality Analysis Simulation Program. Referred to as TAM/WASP, this model was developed by the DOH and ICPRB for TMDL studies. TAM/WASP is a one-dimensional model that uses the hydraulic features of TAM and the water quality characteristics of WASP to characterize the Anacostia River. The model encompasses the full length of the tidal portion of the Anacostia River that extends from the confluence of the Northeast and Northwest branches in Bladensburg, MD to the confluence with the Potomac River at Hains Point. The DOH/ICPRB version of TAM/WASP was further modified and recalibrated for the CSO-related water quality assessment undertaken as part of LTCP development.
- **Rock Creek Model** - Rock Creek was modeled using EPA's Storm Water Management Model, or SWMM. The TRANSPORT Block of SWMM was applied to model hydraulics and pollutant transport.

Section 4 Alternatives Evaluation

4.1 INTRODUCTION

This section describes and evaluates the alternatives developed to meet the TN limit considering the impact of wet weather flows on Blue Plains. All alternative projects have been developed based on the following principal criteria:

- The collection system will continue to deliver a wet weather peak flow of up to 1076 mgd to the outfall sewers, which are the large sewers that convey flow from the pumping stations to Blue Plains
- Evaluate peak flow distribution during wet weather events for conditions as follows:

<i>Treatment Process</i>	<i>Flow Distribution - mgd</i>		
	<i>Maintain Current Peak Flow Rates</i>	<i>Reduce Peak Flow Rates</i>	<i>Reduce Peak Flow Rates and Add Storage</i>
Complete Treatment	740 ¹ , first 4 hours 511, thereafter	555 ² , first 4 hours 511, thereafter	555 ² , first 4 hours 511, thereafter
Excess Flow Treatment	Up to 336	Up to 521 mgd	Up to 225 mgd

Notes: 1. 740 mgd provides for a peak rate of 2.0 times the annual average flow of 370 mgd
2. 555 mgd provides for a peak rate of 1.5 times the annual average flow of 370 mgd

- Combined Sewer System Flow (CSSF) conditions (this constitutes wet weather conditions) exist when the total flow conveyed to the Blue Plains headworks exceeds 511 mgd. CSSF conditions stop when the total flow conveyed to the Blue Plains headworks falls to less than 511 mgd or a period of four hours has elapsed from the start of a CSSF condition; whichever occurs last.
- When CSSF conditions exist, flow conveyed to the Blue Plains headworks receives Complete Treatment and Excess Flow Treatment according to the flow distribution listed in the table above and is discharged from Outfalls 001 and 002.
- When CSSF conditions do not exist, flow conveyed into the Blue Plains headworks is all discharged from Outfall 002 after receiving Complete Treatment
- The predicted quality of the average year combined effluent discharged from Outfalls 001 and 002 will equal or exceed the quality predicted for the LTCP.
- Depending on the alternative, Outfall 001 may serve as a CSO bypass or as a CSO.
- Excess flow treatment will be based on primary clarification using plain sedimentation and enhanced clarification facilities (ECF) employing ballasted flocculation technology. The effluent quality from ECF has been demonstrated as being of a higher quality (e.g. lower pollutant load) compared to that produced by plain sedimentation.
- For an arrangement where the tunnels system is extended to Blue Plains, additional storage will be provided to capture peak flow rates and store such flow prior to delivery to the Blue Plains headworks. Storage capacity has been based on providing tunnel capacity for the difference in the peak flow rates conveyed to Complete Treatment (740 mgd vs. 555 mgd) during the first four hours of a wet weather condition. The tunnel volume required is 740 mgd less 555 mgd which

Alternatives Evaluation

equals 185 mgd for four hours, or 31 million gallons (mg). When additional storage is provided by the tunnel extension, the peak flow rate conveyed into Blue Plains can be reduced to less than 1076 mgd because the storage can be used to equalize the rate being treated while producing an overall effluent quality discharged from Outfalls 001 and 002 of equal or better than that predicted for the LTCP. For an additional storage capacity of 31 mg, the studies show that excess flow treatment employing ECF at a capacity of 225 mgd or an overall peak treatment flow rate of 780 mgd (555 + 225) can be expected to produce an average year effluent quality equal to that produced by treating a peak rate of 1076 mgd (555 + 521 or 740 + 336) without adding additional storage.

- The tunnels system will be arranged to be dewatered during and after a storm for treatment at Blue Plains according to the flow distribution table above and whether or not CSSF conditions exist.
- New biological nitrogen removal facilities (enhanced nitrogen removal or ENR) will be provided with sufficient biological and hydraulic capacity to meet the new total nitrogen effluent limit based on the flow distribution table above and CSSF conditions.

4.2 DESCRIPTION OF ALTERNATIVES

4.2.1 Alternative A

This project is the same as the excess flow improvements in the LTCP. This alternative comprises the addition of four new primary clarifiers for Excess Flow Treatment together with improved hydraulic controls. During wet weather conditions, a peak flow rate of 740 mgd would continue to be conveyed to Complete Treatment for the first four hours. After four hours, the rate to Complete Treatment would be reduced to 511 mgd and up to 336 mgd would be treated in the excess flow facilities during wet weather conditions. This alternative would not have the hydraulic or biological capacity in the initial and complete treatment facilities needed to meet the new total nitrogen effluent limit for Outfall 002. Therefore, this alternative has not been included in the comparison of alternative projects.

4.2.2 Alternative B

The principal features of this alternative are shown on Figure 4-1. This alternative adds the new total nitrogen effluent limit on top of the existing permit conditions for treating wet weather flows under the LTCP. Flow to complete treatment would be 740 mgd for the first 4 hours and 511 mgd thereafter. A maximum of 336 mgd would receive excess flow treatment (primary clarification and disinfection) and be discharged from Outfall 001. In order to meet the new total nitrogen effluent limit and existing permit conditions for treating wet weather flows, new or expanded facilities would be required to both address hydraulic limitations that impact treatment efficiency and clarifier performance and to provide increased nitrogen removal. Additional influent screens and raw wastewater pumps would be constructed to improve reliability. Four additional primary sedimentation tanks would be constructed, as defined in the LTCP. Additional sedimentation basins would be constructed for secondary and nitrification service. Stacked basins would be required because of the lack of land available on the Blue Plains site. Additional nutrient removal facilities would include a centrate treatment facility and eight additional nitrification-denitrification reactors. The centrate treatment system would be needed to remove nitrogen from the recycle produced by dewatering digested sludge and would be contingent upon the construction of digestion facilities.

4.2.3 Alternative C

The principal features of this alternative are shown on Figure 4-2. Under this alternative, peak flow rates to Complete Treatment would be reduced to 555 mgd for the first 4 hours and 511 mgd thereafter. The difference in the maximum rate (1076 mgd) conveyed to the headworks at Blue Plains and that to be conveyed to Complete Treatment (555 mgd) is 521 mgd. New ECF would be constructed with a capacity

of 521 mgd to handle the reduction in peak flow to Complete Treatment. The Anacostia River Tunnels System would remain the same as included in the existing LTCP. The tunnels dewatering pumping station at Poplar Point would, however, pump into a force main that would convey flow captured in the tunnels to new headworks at Blue Plains for treatment in the new ECF. Operating provisions would involve arrangements to dewater the tunnels system during and following wet weather events and to convey the ECF effluent to Outfall 001 and/or Complete Treatment depending on the capacity available in the Complete Treatment facilities.

To meet the new total nitrogen effluent limit at Blue Plains, new or expanded facilities would be required to both address hydraulic limitations that impact treatment efficiency and clarifier performance and to provide increased nitrogen removal. Additional influent screens and raw wastewater pumps would be constructed to improve reliability. The four additional primary sedimentation tanks defined in the LTCP would be replaced by a new ECF facility. This new wet weather treatment system, designed to treat 521 mgd, would allow the peak flow to the existing primary treatment facilities to be limited to 555 mgd. Reducing the peak flow to complete treatment would avoid increasing secondary and nitrification sedimentation capacity. A new fine screening and grit removal facility would be constructed to process CSS flows pumped directly from the tunnels to the new ECF. Additional nutrient removal facilities would include a centrate treatment facility and six additional nitrification-denitrification reactors. The centrate treatment system would be needed to remove nitrogen from the recycle produced by dewatering digested sludge and would be contingent upon the construction of digestion facilities.

4.2.4 Alternative D

The principal features of this alternative are shown on Figure 4-3.

This alternative is based on maintaining a peak flow rate of 1076 mgd from the collection system to Blue Plains. Peak flow rates to Complete Treatment would be reduced to 555 mgd for the first 4 hours and 511 mgd thereafter. A tunnel would be constructed between Poplar Point and Blue Plains, and flows exceeding the complete treatment capacity would be diverted to the tunnel. The total storage would be 157 mg (126 mg + 31 mg) spread over the Anacostia River tunnels system and the new Blue Plains Tunnel. Flow captured in the tunnels would be dewatered through new headworks at Blue Plains for treatment in a new ECF having a capacity of 225 mgd. Operating provisions would include arrangements to dewater the tunnels during and following wet weather events and to convey ECF effluent to Outfall 001 and/or to Complete Treatment depending on the capacity available in the Complete Treatment facilities.

At Blue Plains, the four additional primary sedimentation tanks defined in the LTCP would be replaced by ECF. Peak flows to the existing primary treatment facilities would to be limited to 555 mgd by diverting flows in excess of 555 mgd to tunnel between Poplar Point and the Blue Plains headworks. Reducing the peak flow to Complete Treatment would avoid increasing secondary and nitrification sedimentation capacity. Additional nutrient removal facilities would include a centrate treatment facility and six additional nitrification-denitrification reactors. The centrate treatment system would be needed to remove nitrogen from the recycle produced by dewatering digested sludge and would be contingent upon the construction of digestion facilities.

For this alternative, Outfall 001 could be permitted as a CSO bypass or as a CSO outfall.

4.2.5 Alternative E

For this alternative, peak flows to complete treatment would be reduced to 555 mgd for the first 4 hours and 511 mgd thereafter. The difference in the maximum rate (1076 mgd) entering the headworks and that to be conveyed to complete treatment (555 mgd) would be 521 mgd. New ECF would be constructed with this capacity (521 mgd) to handle the reduction in peak flow to complete treatment. The facilities to

Alternatives Evaluation

dewater the tunnels system would be located at Poplar Point and would discharge into the existing combined sewers in the area. Operating provisions would include arrangements to dewater the tunnels during and following wet weather events. Flow treated by the ECF would be discharged from Outfall 001 and/or conveyed to Complete Treatment depending on the capacity available in the Complete Treatment facilities.

At Blue Plains, additional influent screens and raw wastewater pumps would be constructed to improve reliability. The four additional primary sedimentation tanks defined in the LTCP would be replaced by a new ECF and expanded disinfection facilities. This new wet weather treatment system, designed to treat 521 mgd, would allow the peak flow to the existing primary treatment facilities to be limited to 555 mgd. Reducing the peak flow to complete treatment would avoid increasing secondary sedimentation capacity and constructing a new spent washwater treatment facility. Additional nutrient removal facilities would include a centrate treatment facility and six additional nitrification-denitrification reactors. The centrate treatment system would be needed to remove nitrogen from the recycle produced by dewatering digested sludge and would be contingent upon the construction of digestion facilities.

4.3 EVALUATION OF ALTERNATIVES

4.3.1 General

The alternatives were evaluated on the basis of the following:

- Predicted Blue Plains flows and loads
- Predicted Potomac River water quality in the vicinity of Blue Plains after implementation of a TN/WW Plan.
- Predicted CSO overflows to Anacostia River after implementation of TN/WW Plan
- Implementation schedule
- Opinions of capital, operating, and maintenance costs
- Qualitative factors

Table 4-1 summarizes the results of these comparisons, and the subsequent sections describe the analyses.

FIGURE 4-1

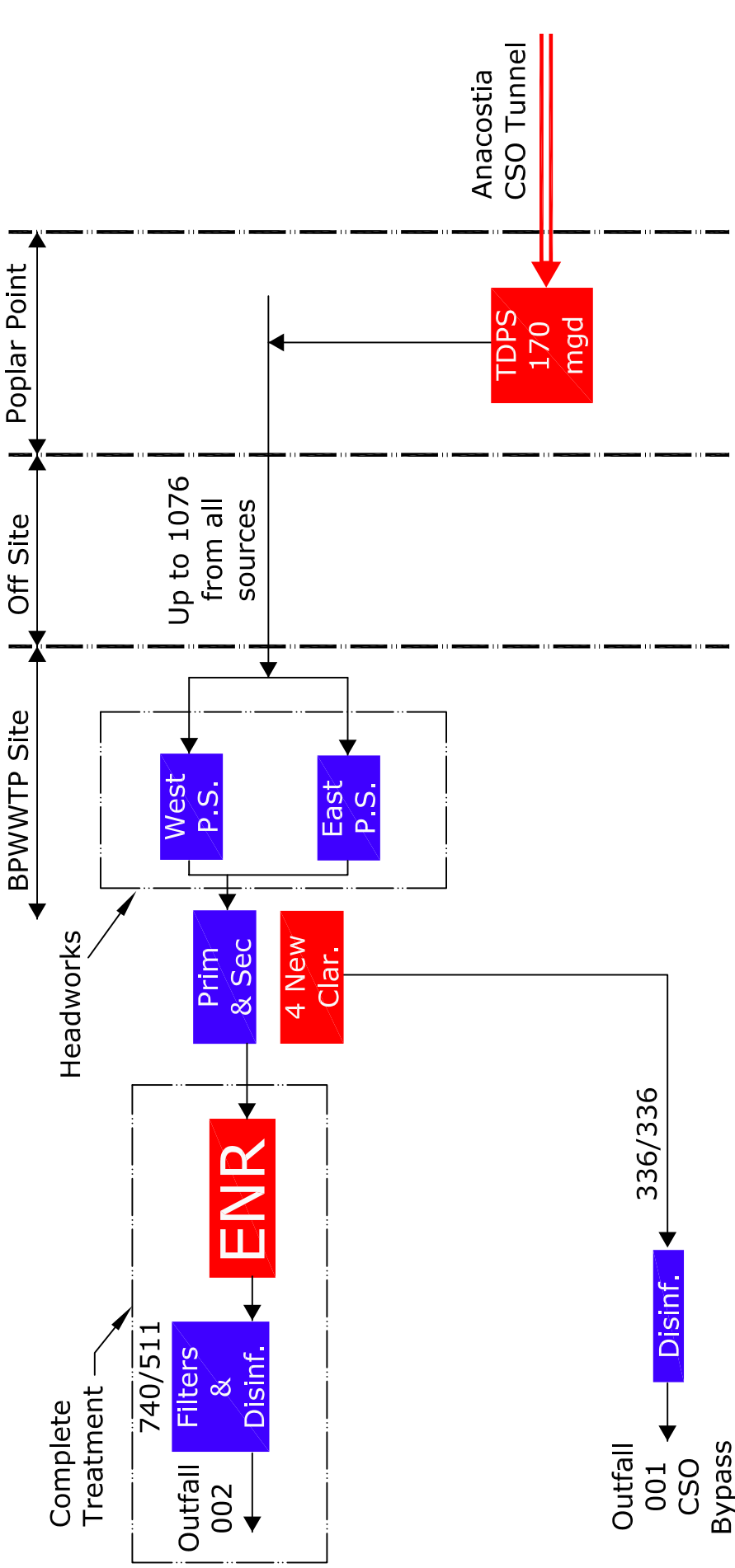

LEGEND
 TDPS - Tunnel Dewatering Pumping Station
 P.S. - Pumping Station
 C.T. - Complete Treatment
 BP Flow Rates (mgd): 1st 4 hrs / After 4 hrs

- Red is new work

ALTERNATIVE B
 NOT TO SCALE

FIGURE 4-2

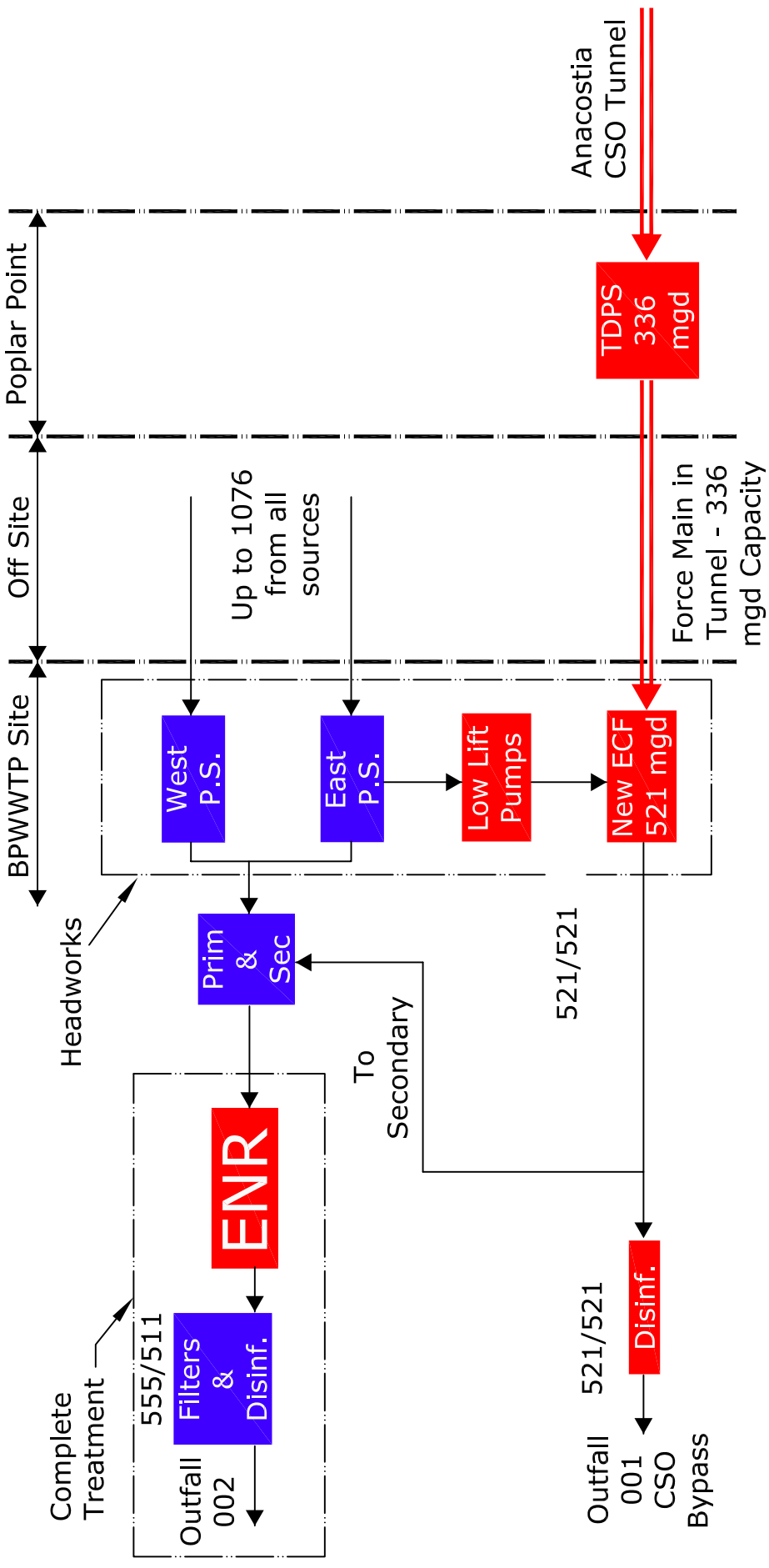

LEGEND
 TDPS - Tunnel Dewatering Pumping Station
 P.S. - Pumping Station
 C.T. - Complete Treatment
 BP Flow Rates (mgd): 1st 4 hrs / After 4 hrs
■ - Red is new work

ALTERNATIVE C
 NOT TO SCALE

METCALF & EDDY
 GREELEY AND HANSEN LLC
 LIMNO-TECH, INC

D.C. WATER AND SEWER AUTHORITY
 TOTAL NITROGEN/WET WEATHER PLAN

FIGURE 4-3

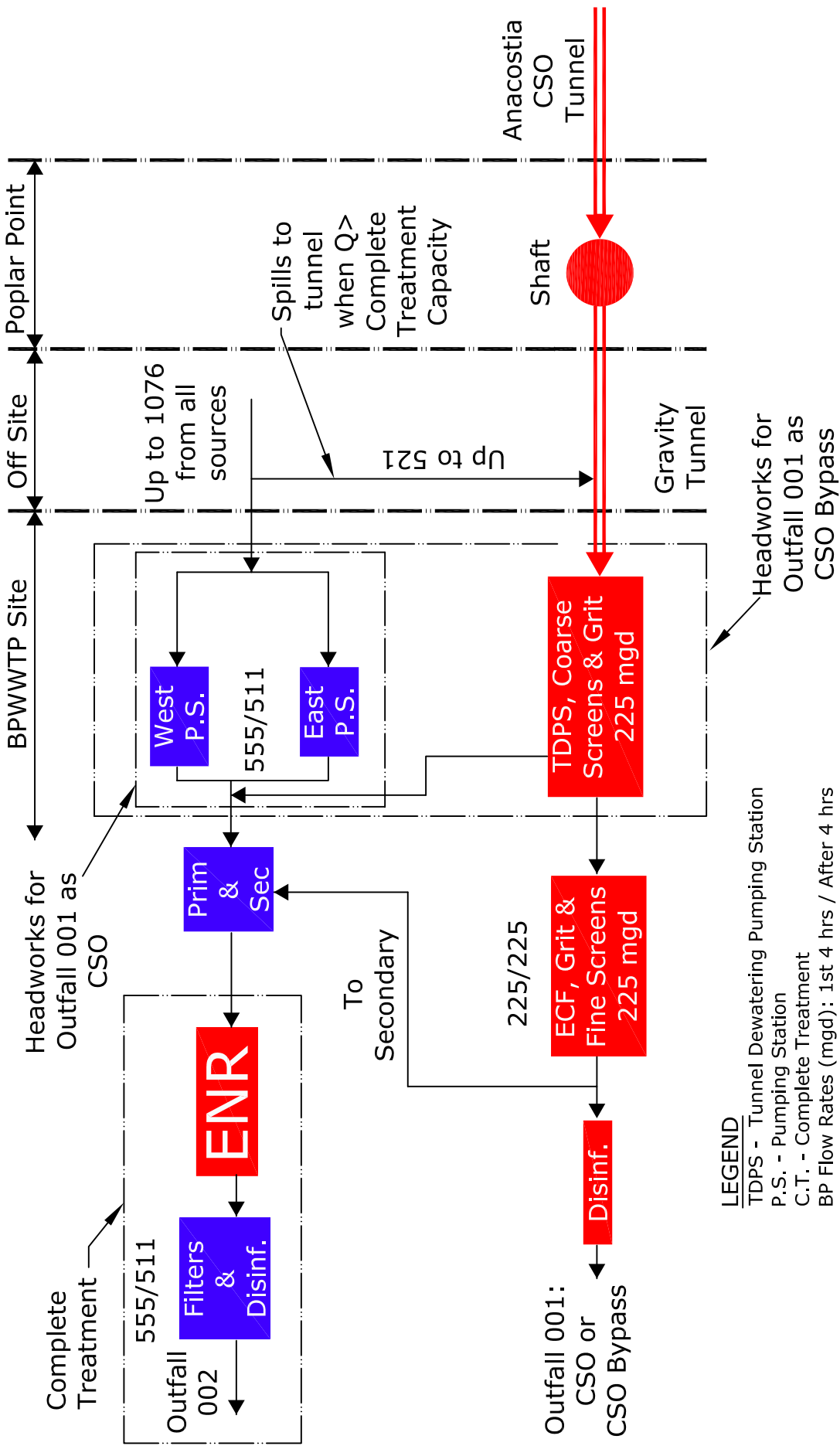

LEGEND
 TDPS - Tunnel Dewatering Pumping Station
 P.S. - Pumping Station
 C.T. - Complete Treatment
 BP Flow Rates (mgd): 1st 4 hrs / After 4 hrs
 ■ - Red is new work

ALTERNATIVE D
 NOT TO SCALE

METCALF & EDDY
 GREELEY AND HANSEN LLC
 LIMNO-TECH, INC

D.C. WATER AND SEWER AUTHORITY
 TOTAL NITROGEN/WET WEATHER PLAN

FIGURE 4-4

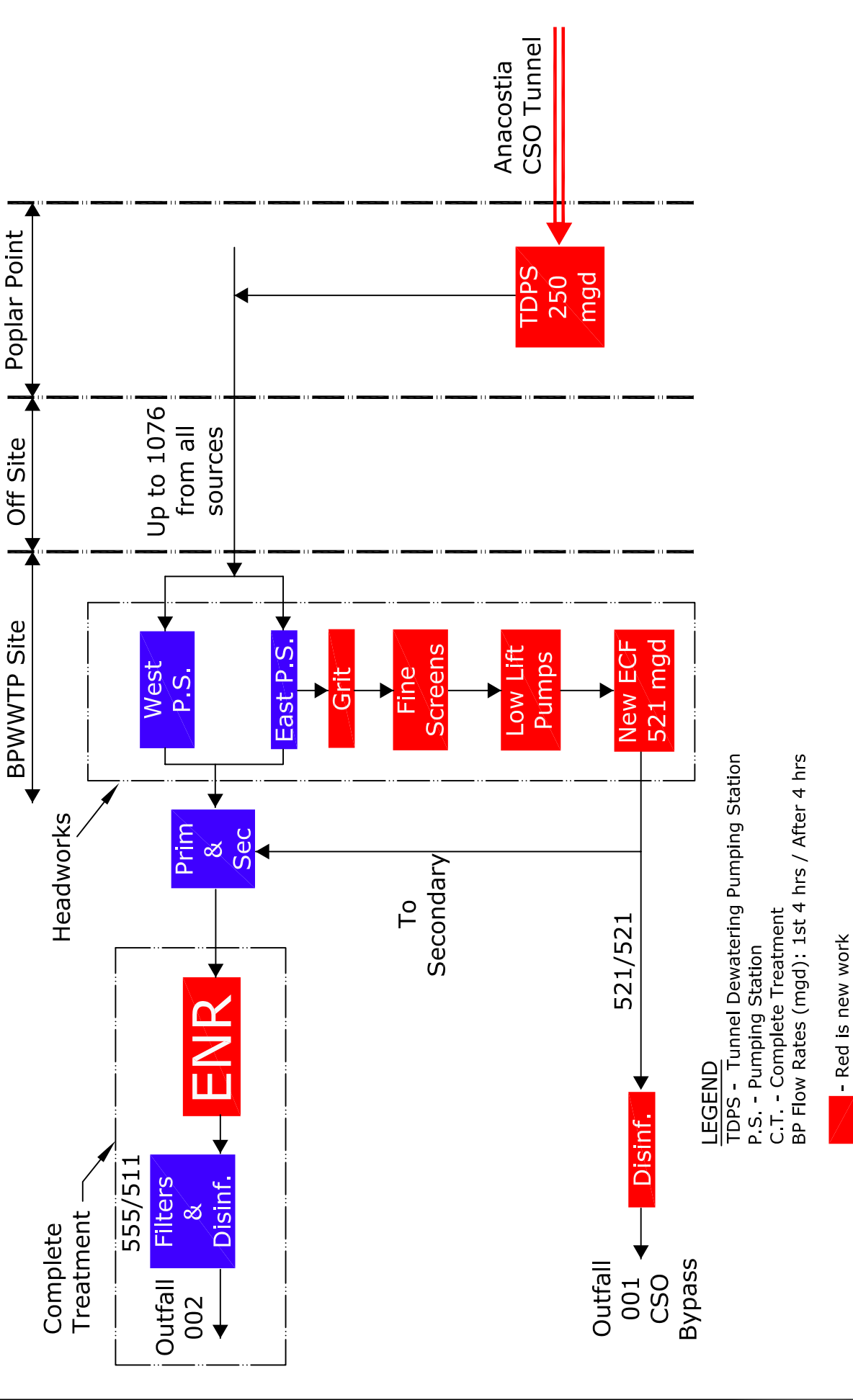

LEGEND
 TDPS - Tunnel Dewatering Pumping Station
 P.S. - Pumping Station
 C.T. - Complete Treatment
 BP Flow Rates (mgd): 1st 4 hrs / After 4 hrs
 - Red is new work

ALTERNATIVE E
 NOT TO SCALE

**Table 4-1
Summary of Alternatives**

Parameter	LTCP	Alternatives			
		B	C	D	E
Facility Capacities					
Blue Plains complete treatment capacity (mgd)					
1 st 4 hrs	740	740	555	555	555
After 4 hrs	511	511	511	511	511
Excess flow treatment (mgd)	336	336			
ECF capacity (mgd)	None	None	521	225	521
Anacostia tunnel storage volume (mg)	126	126	126	157	126
Anacostia tunnel max dewatering rate (mgd)	170	170	336	225	250
Min. tunnel dewatering time (hrs)	59	59	9	17	6
Outfall 001 Flows and Loads					
Volume (mg/avg yr)	1548	1548	2752	2657	2206
Avg Flow Rate (mgd)	4.2	4.2	7.5	7.3	6.0
CBOD5 (lb/avg yr)	730,724	730,724	728,718	703,562	827,912
TSS (lb/avg yr)	1,679,633	1,679,633	607,875	586,890	551,941
Ammonia (lb/yr)	112,320	112,320	127,875	123,461	156,383
TN (lb/avg yr)	219,475	219,475	185,810	179,396	211,577
TP (lb/avg yr)	30,985	30,985	4,083	3,942	3,680
Fecal Coliform (MPN x 10 ¹⁵ /avg yr)	411	411	2.1	2.0	1.7
E Coli (MPN x 10 ¹⁵ /avg yr)	300	300	1.3	1.3	1.1
Outfall 002 Flows and Loads					
Volume (mg/avg yr)	139,596	139,596	138,352	138,505	138,836
Avg Flow Rate (mgd)	382	382	379	379	380
CBOD5 (lb/avg yr)	5,821,153	5,821,153	5,769,278	5,775,659	5,789,461
TSS (lb/avg yr)	8,149,614	8,149,614	8,076,990	8,085,922	8,105,246
Ammonia (lb/yr)	4,424,076	1,629,923	1,615,398	1,617,184	1,621,049
TN (lb/avg yr)	17,579,883	4,469,525	4,503,190	4,434,167	4,477,423
TP (lb/avg yr)	209,562	20,956	20,694	20,792	20,842
Fecal Coliform (MPN x 10 ¹⁵ /avg yr)	106	106	105	105	105
E Coli (MPN x 10 ¹⁵ /avg yr)	67	67	66	66	66
Backcalculated Nitrogen Effluent (mg/L)	15.1	3.8	3.9	3.9	3.9
Outfall 001 + 002 Flows and Loads					
Volume (mg/avg yr)	141,144	141,144	141,104	141,162	141,042
Avg Flow Rate (mgd)	387	387	387	387	386
CBOD5 (lb/avg yr)	6,551,877	6,551,877	6,497,996	6,479,221	6,617,373
TSS (lb/avg yr)	9,829,247	9,829,247	8,684,864	8,672,812	8,657,187
Ammonia (lb/yr)	4,536,396	1,742,243	1,743,273	1,740,645	1,777,432
TN (lb/avg yr)	17,799,358	4,689,000	4,689,000	4,689,000	4,689,000
TP (lb/avg yr)	240,546	51,941	24,852	24,734	24,522
Fecal Coliform (MPN x 10 ¹⁵ /avg yr)	517	517	107	107	107
E Coli (MPN x 10 ¹⁵ /avg yr)	367	367	67	67	67
Anacostia CSO Overflows (Model Predictions)					
#/Avg Year	2	2	0 (1)	0 (1)	0 (1)
Overflow Volume/avg year (mg)	54	54	0 (1)	0 (1)	0 (1)
Potomac Water Quality at Segment 129- Blue Plains					
CSO & WWTP Loads Only					
# months FC > 200/100 ml geomean	0	0	0	0	0
# days FC > 200/100 ml	9	5	1	1	1
# months E Coli > 126/100 ml geomean	0	0	0	0	0

Alternatives Evaluation

Parameter	LTCP	Alternatives			
		B	C	D	E
# days E Coli > 126/100 ml	12	6	1	1	1
# days DO <5.0 mg/L	0	0	0	0	0
Min Day DO (mg/L)	>5	6.2	6.2	6.2	6.2
All Loads Present					
# months FC > 200/100 ml geomean	0	0	0	0	0
# days FC > 200/100 ml	27	22	12	12	12
# months E Coli >126/100 ml geomean	0	0	0	0	0
# days E Coli > 126/100 ml	25	18	7	7	7
# days DO <5.0 mg/L	27	19	20	20	20
Minimum Day DO (mg/L)	4.0	4.6	4.6	4.6	4.6
Capital Cost (\$ M, ENR CCI = 7888)					
	\$ 28	\$ 1,287	\$ 901	\$ 783	\$ 732
% above lowest	N/A	76%	23%	7%	0%
O & M Cost (\$ M, ENR CCI = 7888)					
	\$ 9	\$ 24.5	\$ 24.9	\$ 23.2	\$ 21.8
% above lowest	N/A	12%	14%	7%	0%
Equivalent Annual Cost (A/P, 6.5%, 30 yrs)					
	\$ 2.2	\$ 123.1	\$ 93.9	\$ 83.3	\$ 77.9
% above lowest	N/A	58%	21%	7%	0%

Notes:

1. For these alternatives, modeling predicts no overflows in an average year. At the low levels of CSO overflows projected herein, model accuracy is highly dependent on many variables such as the accuracy of rainfall data, information on the drainage area and other factors. As a result, the model predictions mean that CSO overflows in the range of zero to 2 overflows and 54 mg can be expected in an average year. Further, additional overflows will occur for rain events which exceed or are not represented in the average year. The model predictions contained herein do not change the level of CSO control committed to by WASA in its LTCP, which was approved by EPA and the D.C. Department of the Environment.
2. FC= fecal coliform
3. DO = dissolved oxygen
4. MPN = Most probable number

4.3.2 Predicted Blue Plains Flows and Loads

The collection system model was used in conjunction with the Biowin model for Blue Plains and the process evaluations of the plant to identify the flows and loads produced by Blue Plains for the various alternatives. Table 4-2 summarizes the event mean concentrations (EMCs) used in the analysis.

For Outfall 002, concentrations were set at permit limits. The total nitrogen concentration for outfall 002 was adjusted for each alternative to achieve a TN load of 4,689,000 lbs per year. This adjustment was necessary since each alternative produced a different load from Outfall 001, and since the total load from the sum of Outfalls 001 and 002 must meet the TN annual mass limit.

For Outfall 001, the following EMCs were used:

- Alternative B includes screening, grit removal, primary clarification, and disinfection. This alternative does not include ECF. The EMCs for Outfall 001 for this alternative were set at those used for the LTCP. These EMCs were developed based on review of actual effluent concentrations at Outfall 001 during development of the LTCP.
- For Alternative E, the influent to ECF will be a mixture of sanitary wastewater and captured CSO from the tunnel. When the tunnel is being dewatered, captured CSO will mix with sanitary wastewater because the tunnel dewatering pumping station will discharge to the existing outfall sewers since there is no dedicated conveyance to Blue Plains. The EMCs for this alternative are based on the analyses of the performance of ECF described in Section 2.

Alternatives Evaluation

- Alternatives C and D include ECF and a dedicated conveyance to Blue Plains. In the beginning of a typical storm, the influent to ECF will be a mixture of sanitary wastewater and captured combined sewage. Near the end of the storm, the influent to ECF will be mostly tunnel pumpout. Based on sampling of overflows conducted during the LTCP, CSO captured in the tunnel is much more dilute than the mixture of sanitary wastewater and captured combined sewage. For example, the total nitrogen in CSO captured in the tunnel is approximately 4.9 mg/L, while the total nitrogen in the mixture of sanitary wastewater and captured combined sewage is more than 16 mg/L. The performance of the ECF will be better when treating tunnel pumpout than when treating the mixture of separate sanitary wastewater captured combined sewage. For these alternatives, the EMCs for 001 were developed as a flow weighted average based on the volume of each type of influent treated by ECF (relative volume of tunnel pumpout, versus the mixture of sanitary wastewater and captured combined sewage).

As shown in Table 4-1, Alternatives C and D produce the lowest overall loads from the Blue Plains outfalls. Alternatives C, D and E all produce overall lower pollutant loads than Alternative B.

**Table 4-2
Event Mean Concentrations for Blue Plains Effluent**

Parameter	Units	Outfall 001				Outfall 002	
		LTCP	Alternative B	Alternative C and D	Alternative E	LTCP	Alternatives B, C, D, E
Fecal Coliform	MPN/100 ml	70,206	70,206	200	200	200	200
E. Coli	MPN/100 ml	51,250	51,250	126	126	126	126
CBOD5	mg/L	56.6	56.6	31.8	45	5	5
Ammonia-as N	mg/L	8.7	8.7	5.6	8.5	3.8	(1)
Organic Nitrogen	mg/L	7.6	7.6	1.9	2.5	2	(1)
Nitrite+Nitrate-as N	mg/L	0.7	0.7	0.60	0.5	9.3	(1)
Total Nitrogen	mg/L	17	17	8.1	11.5	15.1	(1)
Ortho Phosphate (PO4)	mg/L	0.800	0.800	0.05	0.067	0.050	0.005
Organic Phosphorus	mg/L	1.600	1.600	0.12	0.133	0.130	0.013
Total Phosphorus	mg/L	2.4	2.4	0.18	0.2	0.18	0.018
Total Suspended Solids	mg/L	130.1	130.1	26.5	30	7	7
Dissolved Oxygen	mg/L	6	6	6	6	6.8	6

Notes:

1. Set to achieve a total TN load from Blue Plains of 4,689,000 lbs per year. TN is the sum of organic nitrogen, ammonia, nitrite and nitrate. Concentrations of the nitrogen constituents varied as follows:
 - a. TN varied from 3.8 to 4.2 mg/L.
 - b. Organic nitrogen varied 0.9 to 1.0 mg/L
 - c. Ammonia varied from 1.4 to 1.5 mg/L
 - d. Nitrite + nitrate varied from 1.5 to 1.7 mg/L

4.3.3 Predicted Potomac River Water Quality

The predicted water quality in the Potomac River for each alternative and for the LTCP is shown in Table 4-1. The water quality is shown for the Potomac River segment where 001 and 002 from Blue Plains discharge into the river. The water quality is shown for two scenarios as follows:

- All loads present – in this scenario, all loads to the receiving water are present: Blue Plains, CSOs, separate stormwater and pollutants from Maryland, Virginia and other localities that discharge into Potomac, Anacostia and Rock Creek. Loads from other sources were obtained by monitoring the receiving streams at the D.C. Boundary during development of the LTCP.

Alternatives Evaluation

- CSO and wastewater treatment plant (WWTP) loads only – In this scenario, only loads from Blue Plains and the CSOs are included in the model. This scenario was run because background loads impose a significant burden and it is sometimes difficult to see the impact of CSO and WWTP load reductions with background loads present. This scenario gives a direct indication of the impact of CSO and WWTP loads on water quality.

The analyses show that all of the alternatives produce better water quality than the LTCP, and that Alternatives C, D and E produce better water quality than Alternative B. Note that Alternatives C, D and E reduce the numbers of days that CSO and Blue Plains discharges cause fecal coliform bacteria concentrations to be above 200 organisms/100 ml by more than half. Similar performance levels are predicted for e. coli.

4.3.4 Predicted CSO overflows to Anacostia River

All of the options are able to reduce overflows to the Anacostia, Potomac River and Rock Creek to a level equal to the LTCP.

4.3.5 Schedule to Implement

The time required for construction of the alternatives was evaluated. Alternatives C, D, and E were determined to be equivalent in terms of length of time needed to construct. This is because all of the alternatives involve conventional construction, with an approximately equivalent degree of interfacing with existing facilities. Construction of Alternative B would require significantly longer to place in operation than the other options. This is because Alternative B includes construction of double deck sedimentation basins and considerable interfacing with the existing infrastructure at Blue Plains. In addition, the extensive interfacing with existing facilities at Blue Plains will require staging construction, taking facilities out of service one at a time to perform the work. These factors add significant time to construct this option.

4.3.6 Cost Opinions

The capital, operating and maintenance and equivalent annual cost are summarized in Table 4-1. Capital costs include engineering, construction, construction management and project administration. The equivalent annual cost was calculated at an interest rate of 6.5 percent using 30-year bonds.

At this stage of project development, costs are considered to have an accuracy of +50%, -30%. This means costs could be in the range of approximately 50% higher or 30 % lower.

Alternative B is significantly more expensive than the other options. Given the accuracy of the cost estimates, Alternatives D and E are considered to be approximately equal given the level of accuracy of the estimate.

4.3.7 Qualitative Factors

Major qualitative factors for each of the alternatives are described below, while Table 4-3 summarizes these considerations.

- Alternative B – This alternative involves considerable interfacing with existing infrastructure at Blue Plains, including the need to construct double deck sedimentation basins. This increases the cost, schedule and risk associated with construction. In this alternative, the tunnel dewatering pumping stations (TDPS) for the Anacostia Tunnel would be located at Poplar Point. There are plans for considerable public and private redevelopment at Poplar Point, including construction of a possible soccer stadium. Construction of a TDPS would be an industrial use out of character with the proposed concept for redevelopment in the area. There is considerable doubt that such a facility would be allowed in that area. Another disadvantage of this alternative is that operating

and controlling the TDPS is more difficult than some of the other options. This is because the TDPS pumps into the existing outfall sewers downstream of Main and O Street Pumping Stations. The output of the TDPS would need to be modulated so as to not exceed the capacity of the Main and O Outfall Sewers, the capacity of Blue Plains and to prevent CSO overflows at the Bolling Air Force CSO, outfall 003. This would require a control system that looks at multiple variables and adjusts TDPS output accordingly. While this type of configuration is technically feasible, it is complex.

- Alternative C – this alternative offers the advantage of being simpler to operate than Alternative B since this alternative pumps directly to the ECF without interfacing with the existing sewers. Significant disadvantages of this alternative include the need for a major pumping complex at Poplar Point. In addition, this alternative requires construction of a force main from Poplar Point to Blue Plains. Since the land between Poplar Point and Blue Plains is occupied by Bolling Air Force base and other military facilities, finding a suitable right of way for an open-cut force main may be difficult and impractical. The force main could be constructed in a tunnel. If a tunnel were required, then Alternative D which includes such a tunnel offers greater advantages.
- Alternative D – this alternative offers significant qualitative advantages over the other options. First, the flow management is simple and reliable compared to the other options because there is a gravity overflow to the tunnel at the influent side of Blue Plains. If flows in the collection system exceed the complete treatment capacity, the system will overflow by gravity without operator or mechanical intervention. The TDPS and Blue Plains raw wastewater pumping stations can withdraw wastewater up to their capacity out of the existing outfall sewers and out of the Blue Plains Tunnel. Another advantage of this option is that it avoids construction of a major pumping complex at Poplar Point since the TDPS would be at Blue Plains. A replacement for the existing Poplar Point Pumping Station would still need to be constructed at Poplar Point. However, this is a much smaller facility and is a replacement for a facility that is already on site. Another advantage of this option is that the tunnel to Blue Plains will provide another conduit to convey wastewater to Blue Plains. If there is a failure in one of the outfall sewers or the need to take it out of service, the tunnel to Blue Plains could be used to provide redundancy. Lastly, if Blue Plains is out of service due to a loss of power or other catastrophic reason, the tunnel can provide significant storage volume in dry weather to contain wastewater which would otherwise need to be discharged without treatment. With 157 mg of storage, and an average plant flow rate of 370 mgd, up to 10 hours of storage for the flow from the entire service area would be available. This operation thus offers considerable advantages in terms of the ability to meet regulatory obligations.
- Alternative E – This alternative offers the advantage of low cost. However, Alternative E has the disadvantage of requiring the construction of a pumping complex at Poplar Point, similar to Alternatives B and C. In addition, the flow management of this alternative is complex, similar to that described for Alternative B.

Alternatives Evaluation

**Table 4-3
Qualitative Factors**

Alternative	Advantages	Disadvantages
B	<ol style="list-style-type: none"> 1. Provides complete treatment for peaking factor of 2.0. 	<ol style="list-style-type: none"> 1. Difficult to construct 2. Interfacing with existing facilities at Blue Plains presents a risk 3. Longer schedule 4. Requires pumping station complex at Poplar Point
C	<ol style="list-style-type: none"> 1. Simpler to control/operate than Alternative E, but much more difficult to control/operate than Alternative D 	<ol style="list-style-type: none"> 1. Difficult, maybe impossible to find open cut right-of-way for force main from Poplar Point to Blue Plains. 2. Requires pumping station complex at Poplar Point 3. Difficult to expand
D	<ol style="list-style-type: none"> 1. Flow management is simple/reliable 2. Avoids pumping station complex at Poplar Point 3. Avoids lost opportunity cost for development 4. Easier to expand 5. Blue Plains can be out of service for 8+ hrs 6. Less risk of permit noncompliance 7. Parallels outfall sewers to Blue Plains, and provides redundancy in the event of an emergency or need to repair existing pipes. 8. Tunnel P.S. at Blue Plains 9. Smaller ECF 10. Easier connections to existing at Blue Plains 	<ol style="list-style-type: none"> 1. Increased length of tunnels may increase risk.
E	<ol style="list-style-type: none"> 1. None, except cost 	<ol style="list-style-type: none"> 1. Difficult to operate and control 2. Requires pumping station complex at Poplar Point. 3. Not easily expandable 4. Large ECF 5. Requires increase in capacity of Outfall 001 at Blue Plains from 336 to 521 mgd.

Section 5 Recommended Plan

5.1 INTRODUCTION

This section describes the TN/WW plan that WASA has selected. In order to select the recommended plan, WASA considered the ability to meet water quality standards, the time it will take to implement the plan, cost effectiveness, and non-monetary factors such as reliability and ease of operation and maintenance. This section describes the recommended plan, the proposed implementation schedule and revisions necessary to the NPDES Permit and LTCP Consent Decree to accommodate the plan.

5.2 RECOMMENDED PLAN

Based on the alternatives evaluation, Alternative A was rejected because it could not comply with the TN permit limit.

Alternatives B and C are not cost effective in terms of capital cost compared to Alternatives D and E. Also, the water quality predicted for Alternative B is not as good as that predicted for Alternatives C, D and E. The predicted water quality for Alternatives C, D and E is equal. Based on cost effectiveness and predicted water quality performance, Alternatives B and C were not considered further.

Alternatives D and E appear to be equal in terms of cost effectiveness and predicted water quality. Alternative D includes extension of the tunnels system to Blue Plains and provides greater reliability for CSO control in terms of capture, treatment and expandability.

The comparative evaluations show Alternative D to provide the best features for water quality, performance, reliability, cost effectiveness and capability to meet CSO control requirements. Alternative D is, therefore, recommended for selection as the TN/WW Plan. The major components of the recommended plan are as follows:

- Blue Plains complete treatment capacity - Blue Plains will provide complete treatment for up to 555 mgd for the first four hours and 511 mgd thereafter. In accordance with the existing NPDES permit, combined sewer system flow (CSSF) conditions (i.e. wet weather events) exist and start when plant influent flow is greater than 511 mgd. CSSF conditions stop four hours after plant influent flow drops below 511 mgd or 4 hours has elapsed since the start of CSSF conditions, whichever occurs last.
- Enhanced nitrogen removal (ENR) – ENR facilities will be constructed with capacity to provide complete treatment for the flow rates identified above and to meet the new total nitrogen effluent limit. ENR technologies to meet the new total nitrogen effluent limit will be evaluated. Technologies that may be evaluated include conventional nitrification/denitrification reactors, moving bed biofilm reactors (MBBRs), biological anoxic flooded filters (BAFs) and integrated fixed film activated sludge (IFAS). The evaluation will include pilot studies of one or more technologies to select the appropriate process and to obtain detailed information on parameters for design.
- Enhanced Clarification Facility (ECF) – a 225 mgd ECF facility will be constructed at Blue Plains. Pilot testing of this treatment technology will be performed to confirm its suitability and parameters for design.
- Tunnel to Blue Plains and System Storage Volume – a new tunnel will be constructed from Poplar Point to Blue Plains. The total tunnels system storage volume will be increased from the

Recommended Plan

126 mg included in the LTCP to 157 mg. The diameters of the tunnels system and the apportionment of the storage volume among the various tunnel sections will be dependent on facility planning. This new tunnel segment will serve as a flow equalization facility which provides for reducing the capacity of the ECF and peak flow rates to complete treatment.

- Outfall Sewer Overflow to Blue Plains Tunnel – a connection between the existing Outfall sewers on the influent side of Blue Plains and the tunnel to Blue Plains will be constructed. This facility will allow flow from the collection system that exceeds the complete treatment capacity of the plant to overflow to the tunnel.
- Tunnel Dewatering Pumping Station – in the Final LTCP, the tunnel dewatering pumping station was to be constructed at the tunnel terminus at Poplar Point. As part of the TN/WW plan, the tunnel dewatering pumping station at Poplar Point will be deleted and constructed at the new terminus of the tunnel at Blue Plains. The pumping station will be sized to have a minimum firm capacity of 225 mgd, equal to the capacity of the ECF. In addition, the facility will have the ability to dewater the tunnels system to the new ECF and discharge ECF effluent to complete treatment for discharge at Outfall 002 or for discharge at Outfall 001.

The estimated cost of the recommended plan is \$783 million (capital cost, ENR construction cost index = 7888, December 2006). Figure 5-1 presents a schematic of the recommended plan.

The following is a description of the operation of the recommended plan during a typical rain event:

- As rain occurs in the collection system, flows to Blue Plains will exceed 511 mgd, triggering the start of CSSF conditions.
- For the first four hours, flows up to 555 mgd will be conveyed to complete treatment and be discharged at Outfall 002. Flows in excess of 555 mgd that are conveyed by the collection system (up to 1076 mgd) will overflow to the tunnel. In accordance with the LTCP, CSOs on the Anacostia River will also be captured by the tunnel up to the diversion capacity specified in the NPDES Permit. The tunnel dewatering pumping station will pump up to 225 mgd to ECF for treatment and discharge at Outfall 001.
- If the storm lasts long enough, the amount conveyed to complete treatment will be reduced from 555 mgd for the first four hours and 511 mgd thereafter. The difference between the available complete treatment capacity and the flow conveyed by the collection system will overflow to the tunnel.
- If the storm is large enough, the tunnel system may fill up and then it will overflow to the receiving waters.
- When the storm recedes, flows from the collection system will decline. If flows from the collection system drop below the available complete treatment capacity (555 mgd for the first four hours and 511 mgd thereafter), a portion of the flow from ECF will be diverted to complete treatment to maintain the flow through complete treatment at its design capacity. The balance of the flow from ECF will be disinfected and discharged at Outfall 001. This approach maximizes the flow receiving complete treatment.

FIGURE 5-1

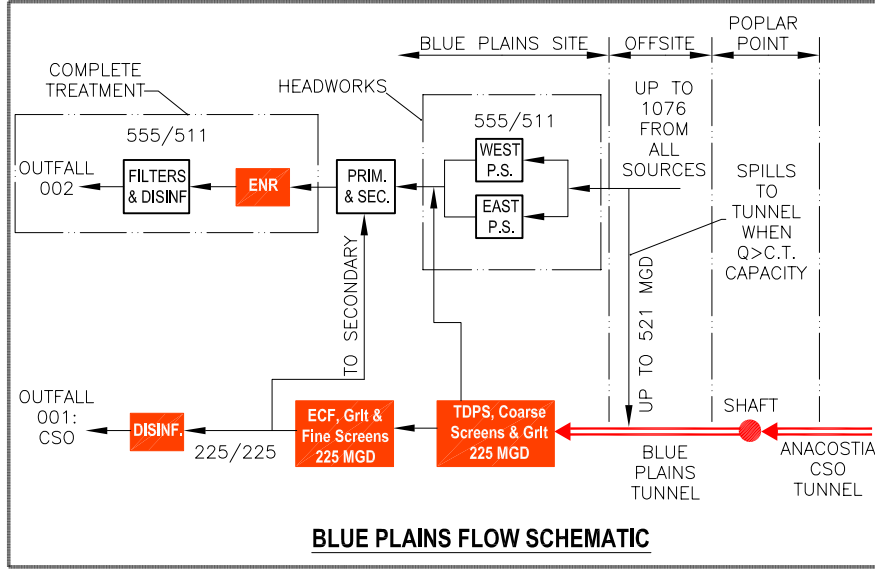
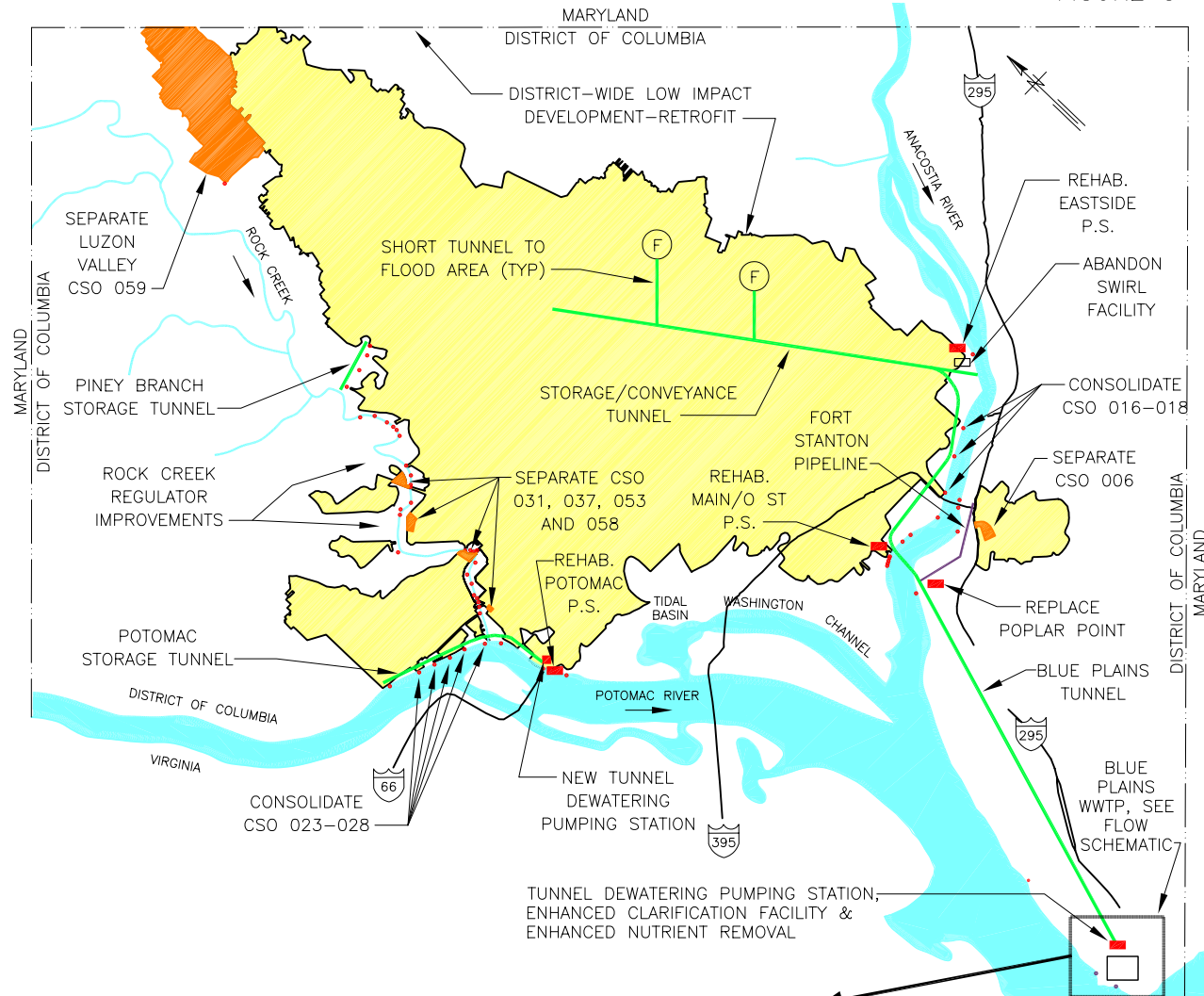

- LEGEND**
- CSO OUTFALL
 - WWTP OUTFALL
 - COMBINED SEWER AREA
 - COMBINED SEWER AREA TO BE SEPARATED
 - NEW PUMPING STATION OR MODIFIED EXIST. PUMPING STATION
 - NEW TUNNEL
 - NEW PIPELINE
 - (F) FLOOD AREA
- TDPS TUNNEL DEWATERING PUMPING STATION
 P.S. PUMPING STATION
 C.T. COMPLETE TREATMENT
 ECF ENHANCED CLARIFICATION FACILITY
 ENR ENHANCED NUTRIENT REMOVAL
 BLUE PLAINS FLOW RATES (MGD)
 1ST 4 HRS/AFTER 4 HRS

RECOMMENDED PLAN

1 MILE 1/2 0 1 MILE

METCALF & EDDY
 GREELEY AND HANSEN LLC
 LIMNO-TECH, INC

D.C. WATER AND SEWER AUTHORITY
 TOTAL NITROGEN/WET WEATHER PLAN

Recommended Plan

5.3 PREDICTED PERFORMANCE OF RECOMMENDED PLAN

The recommended plan will provide enhanced nitrogen removal to meet the requirements of the proposed NPDES permit. In addition, the recommended plan will provide the following:

- Reduced pollutant loads discharged to the receiving waters from Blue Plains Outfalls 001 and 002 when compared to the LTCP
- Better water quality in the Potomac River than the approved LTCP. Note that the Final LTCP was determined by EPA and D.C. DOE to meet water quality standards. The recommended plan thus provides water quality better than that required to meet water quality standards.
- CSO reduction performance equal to or better than that provided for in the approved LTCP.

Table 5-1 summarizes the predicted performance of the recommended plan and compares it to the performance of the LTCP.

**Table 5-1
Predicted Performance of Recommended Plan in Average Year**

Parameter	LTCP	Recommended Plan – Alternative D
Outfall 001 Flows and Loads		
Volume (mg/avg yr)	1548	2657
Avg Flow Rate (mgd)	4.2	7.3
CBOD5 (lb/avg yr)	730,724	703,562
TSS (lb/avg yr)	1,679,633	586,890
Ammonia (lb/yr)	112,320	123,461
TN (lb/avg yr)	219,475	179,396
TP (lb/avg yr)	30,985	3,942
Fecal Coliform (MPN x 10 ¹⁵ /avg yr)	411	2.0
E Coli (MPN x 10 ¹⁵ /avg yr)	300	1.3
Outfall 002 Flows and Loads		
Volume (mg/avg yr)	139,596	138,505
Avg Flow Rate (mgd)	382	379
CBOD5 (lb/avg yr)	5,821,153	5,775,659
TSS (lb/avg yr)	8,149,614	8,085,922
Ammonia (lb/yr)	4,424,076	1,617,184
TN (lb/avg yr)	17,579,883	4,434,167
TP (lb/avg yr)	209,562	20,792
Fecal Coliform (MPN x 10 ¹⁵ /avg yr)	106	105
E Coli (MPN x 10 ¹⁵ /avg yr)	67	66
Backcalculated Nitrogen Effluent (mg/L)	15.1	3.9
Outfall 001 + 002 Flows and Loads		
Volume (mg/avg yr)	141,144	141,162
Avg Flow Rate (mgd)	387	387
CBOD5 (lb/avg yr)	6,551,877	6,479,221
TSS (lb/avg yr)	9,829,247	8,672,812
Ammonia (lb/yr)	4,536,396	1,740,645
TN (lb/avg yr)	17,799,358	4,689,000
TP (lb/avg yr)	240,546	24,734
Fecal Coliform (MPN x 10 ¹⁵ /avg yr)	517	107
E Coli (MPN x 10 ¹⁵ /avg yr)	367	67
Anacostia CSO Overflows		
#/Avg Year	2	0 (1)
Overflow Vol/avg year (mg)	54	0 (1)

Parameter	LTCP	Recommended Plan – Alternative D
Potomac Water Quality at Segment 129- Blue Plains		
CSO & WWTP Loads Only		
# months FC > 200/100 ml geomean	0	0
# days FC > 200/100 ml	9	1
# months E Coli >126/100 ml geomean	0	0
# days E Coli > 126/100 ml	12	1
# days DO <5.0 mg/L	0	0
Min Day DO (mg/L)	>5	6.2
All Loads Present		
# months FC > 200/100 ml geomean	0	0
# days FC > 200/100 ml	27	12
# months E Coli >126/100 ml geomean	0	0
# days E Coli > 126/100 ml	25	7
# days DO <5.0 mg/L	27	20
Min Day DO (mg/L)	4.0	4.6

Notes:

1. Modeling predicts no overflows in an average year. At the low levels of CSO overflows projected herein, model accuracy is highly dependent on many variables such as the accuracy of rainfall data, information on the drainage area and other factors. As a result, the model predictions mean that CSO overflows in the range of zero to 2 overflows and 54 mg can be expected in an average year. Further, additional overflows will occur for rain events which exceed or are not represented in the average year. The model predictions contained herein do not change the level of CSO control committed to by WASA in its LTCP, which was approved by EPA and the D.C. Department of the Environment.

5.4 SCHEDULE

The schedule for implementing nitrogen control was developed considering the following factors:

- Constructability – Blue Plains is an operating treatment plant that must remain in operation during construction. In order to add enhanced nitrogen control, it is necessary to phase the work such as taking units out of service sequentially to avoid compromising the treatment capacity. Consideration was given to the difficulties, practicality and past experience of working at an operating facility while performing major construction. It will also be necessary to limit flow peaks to complete treatment because of units being out of service for ENR upgrade work.
- Achieve nitrogen control as early as practicable – In accordance with the Chesapeake Bay program commitments and regulatory agency comments, preference was given to achieve the nitrogen permit limit at the earliest practicable date.

Based on this evaluation, the schedule identified below has been developed. The schedule is based on receipt of EPA approval of the TN/WW Plan by January 1, 2008. If approval occurs after this date, then revision of the schedule will be required.

- Nitrogen Limit Compliance – place nutrient removal facilities in operation by July 1, 2014, which is 6 years and 6 months after approval of the TN/WW Plan (assumed to occur January 1, 2008). Since nitrogen compliance is judged based on a full calendar year, start compliance with the TN limit the first full calendar year following placing facilities in operation.
- Wet Weather Facilities - place facilities in operation by March 23, 2018, which is 10 years and 3 months after approval of the TN/WW Plan (assumed to occur January 1, 2008). Note that the 2018 date is also the deadline in the LTCP Consent Decree for placing in operation the Anacostia Tunnel and appurtenances from Poplar Point to Northeast Boundary. The wet weather facilities include the Enhanced Clarification Facility, Tunnel to Blue Plains and Tunnel Dewatering Pumping Station.

Recommended Plan

A breakdown of the proposed schedule is shown on Figure 5-2. The schedule breakdown comprises the following elements:

- Facility Planning - this step comprises the next activity following approval of the TN/WW Plan and includes developing additional definition of the project necessary for preliminary design. Examples include pilot studies, nitrogen removal process studies, planning level geotechnical investigations and developing proposed process arrangements and sites for facilities, establishing bases for design, studies of system hydraulics, and other elements needed to define the function and interaction of the system.
- Design – this step consists of performing preliminary and final designs and preparing contract documents (plans and specifications) to obtain bids for construction.
- Bid/Award – this step includes advertising for bids, responding to contractor questions, receiving and evaluating bids, preparing the contract and awarding and executing the contract with the construction contractor.
- Construction - this includes the building of the facility.
- Place in Operation – at this milestone, the facility is operational and is performing the function for which it is intended. Construction may extend beyond this milestone for such items as landscaping, final cleanup, punch list items or to address claims arising during construction.

**Figure 5-2
Project Schedule**

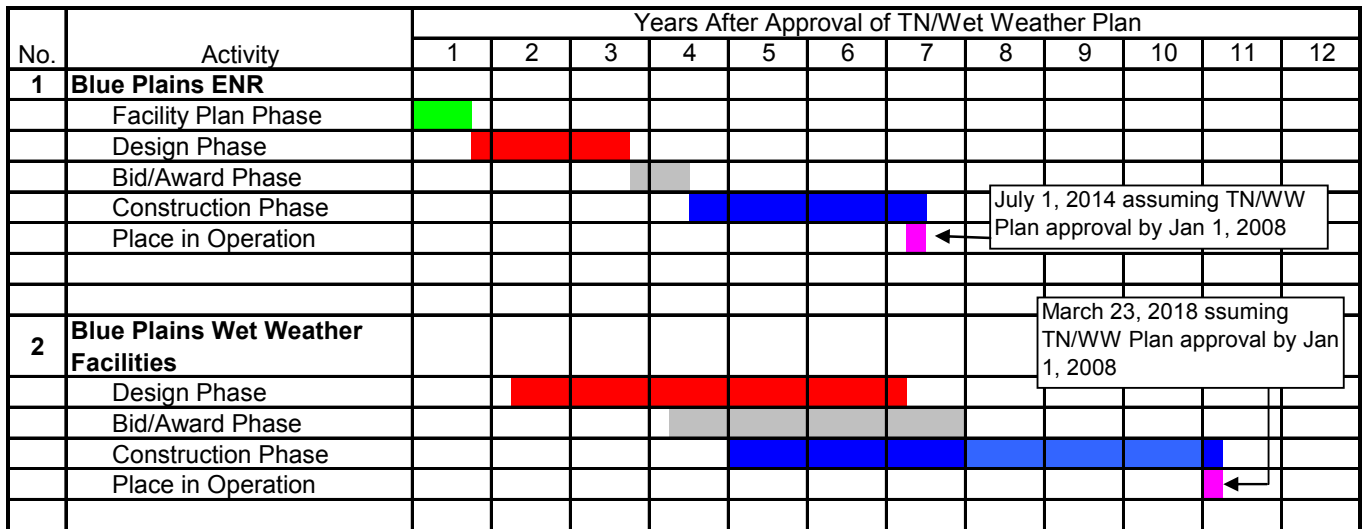

5.5 OUTFALL 001 NITROGEN ALLOCATION AND PERMITTING APPROACH

The Blue Plains NPDES permit was modified on April 5, 2007 to include a TN limit for Blue Plains of 4.689 million pounds of nitrogen per year. The permit allocated this entire load to Outfall 002, the complete treatment outfall. For Outfall 001, there were no allocations for nitrogen or any other parameter. The fact sheet accompanying the permit indicated the derivation of the TN limit was as shown on Table 5-2. The fact sheet did not explain why an allocation was not assigned to Outfall 001.

**Table 5-2
EPA’s Derivation of TN Limit for Blue Plains
Fact Sheet Accompanying April 5, 2007 NPDES Permit Modification**

Source	TN Load Allocation (mil lbs/yr)
D.C. CSO after LTCP	0.0053
D.C. non-point sources	0.28
D.C. portion of Blue Plains	2.115
Total D.C.	2.4
D.C. portion of Blue Plains	2.115
Maryland part of Blue Plains	1.993
Virginia part of Blue Plains	0.581
Total Blue Plains	4.689

The LTCP demonstrated that Outfall 001 met the requirements of a CSO bypass per the CSO Policy. This was approved along with the entire LTCP and the NPDES permit recognized Outfall 001 as a CSO bypass.

As with other CSOs, flows and pollutant concentrations from Outfall 001 vary dramatically based on the rainfall, the nature of the storm event, antecedent moisture conditions and other factors. Like other CSOs, end of pipe effluent limits are inappropriate for this outfall. This was recognized in the NPDES permit which includes no effluent limits for bacteria, TSS, BOD or other parameters for Outfall 001 or any other CSO. Instead, the LTCP and permit provide that the water quality performance of Outfall 001 and the other CSOs are to be evaluated by post construction monitoring. The evaluation would include monitoring of the discharges and the receiving waters for an extended period of actual operation. The measured discharges from the outfalls and the measured water quality in the receiving waters would be related back to average year conditions using modeling. The predicted performance in the average year would be the basis for determining whether the LTCP (including 001) was performing as predicted and therefore meeting water quality standards or whether additional CSO controls were required. This was the basis for EPA and the D.C. Department of the Environment approval of the LTCP as meeting water quality standards, subject to post construction monitoring. This approval was made based on the predicted performance of Outfall 001, the remaining CSOs and the predicted water quality after implementation of the LTCP.

In addition to the new ECF, implementation of the TN/WW Plan includes a tunnel dewatering pumping station, grit removal and coarse screening facilities to be constructed for Outfall 001. These facilities provide separate headworks for Outfall 001. As a result, Outfall 001 could be permitted either as a CSO bypass or as a CSO outfall. The allocation of nitrogen under each of these approaches is described below:

- Outfall 001 as a CSO Bypass – Under this approach, a nitrogen load would be allocated to Outfall 001 as a CSO bypass. The load would be treated in a fashion similar to CSOs in that there would be no mass or concentration permit limit and the performance would be evaluated based on post-construction monitoring. The load allocated to Outfall 002 would be

Recommended Plan

reduced accordingly to maintain the same total nitrogen load for the District. Table 5-3 shows this load allocation.

- Outfall 001 as a CSO – Under this approach, the nitrogen load allocated to Outfall 001 would be added to the CSO nitrogen load. The load would be treated like all of the other CSOs in that there would be no mass or concentration permit limit and the performance would be evaluated based on post-construction monitoring. The load allocated to Outfall 002 would be reduced to maintain the same total nitrogen load for the District. Table 5-3 shows this load allocation.

**Table 5-3
Proposed TN Load Allocation – Outfall 001 as a CSO Bypass or CSO**

Source	TN Load Allocation (mil lbs/yr)		
	Fact Sheet Accompanying April 5, 2007 Permit Modification	Outfall 001 as a CSO Bypass	Outfall 001 as a CSO
D.C. CSO after LTCP	0.0053	0.0053	0.0053 + 0.18 = 0.1853
D.C. Blue Plains CSO Bypass (001)	-	0.18	-
D.C. non-point sources	0.28	0.28	0.28
D.C. portion of Blue Plains	2.115	2.115 – 0.18 = 1.935	2.115 – 0.18 = 1.935
Total DC	2.4	2.4	2.4
D.C. portion of Blue Plains	2.115	1.935	1.935
Maryland part of Blue Plains	1.993	1.993	1.993
Virginia part of Blue Plains	0.581	0.581	0.581
Total Blue Plains	4.689	4.509	4.509

Under either approach, the nitrogen load allocated to Outfall 001 would be evaluated based on post construction monitoring and performance with the allocation measured against the average year. This is entirely consistent with the allocations to CSOs made for other parameters under various TMDLs and the fact that nitrogen allocations are to be made TMDLs. Average year TMDL allocations to CSOs include daily and annual allocations for representative climate periods. For TMDLs with climate periods different than that used for the LTCP, the TMDL will be translated to an equivalent TMDL for the LTCP climate period.

Considering the foregoing, it is recommended that Outfall 001 be permitted as a CSO because it will have a separate headworks after implementation of the TN/WW Plan and because this approach best fits and makes clear the performance expectations and evaluations for this outfall.

5.6 INTERIM FLOW LIMITS AT BLUE PLAINS

Currently, rehabilitations and improvements to the plant are underway in a program called the liquid phase process improvement program. During this program, the NPDES permit provides for reduced flow limits. Complete treatment capacity is limited to 511 mgd for up to 4 hours. After the first 4 hours, the complete treatment capacity is reduced to 450 mgd. Excess flow treatment remains at up to 336 mgd.

In order to accommodate ongoing construction at Blue Plains, these limits on the flow must remain in place until the start of operations of the new ECF complex.

5.7 NPDES PERMIT CONDITIONS

The NPDES permit will need to be modified to agree with TN/WW plan. Modifications for the NPDES permit are summarized as follows and are applicable after the Enhanced Clarification facilities have been placed in operation.

- Part 1, Section A – Effluent Limitations and Monitoring Requirements Outfall 001
 - Revise the status of Outfall 001 to reflect it being a separate CSO and the discharge for the new ECF complex
 - Revise the description of the treatment provided to Outfall 001 to include enhanced clarification and disinfection
 - Revise the maximum flow rate to be treated and discharged from Outfall 001 to be 225 mgd
 - Discharge limitations and monitoring remain unchanged

- Part 1, Section B – Effluent Limitations and Monitoring Requirements Outfall 002
 - Dry Weather Flow (DWF) conditions exist when plant influent flows are equal to or less than 511 mgd.
 - Combined Sewer System Flow (CSSF) conditions exist and shall be deemed to start when plant influent flows are greater than a rate of 511 mgd. CSSF conditions shall be deemed to stop 4 hours after plant influent flows drop to a rate less than 511 mgd or a period of 4 hours has elapsed since the start of CSSF conditions, whichever occurs last.
 - Delete Excess Flow Treatment
 - The following flows shall receive complete treatment:
 - For the first four hours, plant influent flows less than or equal to 555 mgd
 - After four hours, plant influent flows up to 511 mgd
 - When DWF conditions exist, no flow may be discharged from Outfall 001.
 - When CSSF conditions exist, plant influent flows greater than the 555 mgd or 511 mgd rates required to receive Complete Treatment; shall receive Excess Flow Treatment and a maximum rate of 225 mgd may be discharged from Outfall 001

- Part III, Section D – Post Construction Monitoring
 - At subsection 4, add a provision for translating TMDLs and other allocations developed for climate periods different than that used for the LTCP, to be translated to an equivalent TMDL or allocation for the LTCP climate period.

- Clarify the nitrogen allocation in Part 1 Section B and in Part IV Section E to indicate that the permit load applies to Outfall 002 only.

- Other changes needed to make the NPDES Permit consistent with the TN/WW Plan.

5.8 CONSENT DECREE MODIFICATIONS

The LTCP consent decree will need to be modified to conform to the TN/WW plan. Modifications for the LTCP consent decree are summarized as follows:

- Adjust the Anacostia River Projects tunnels storage capacities
- Adjust the work included for the Poplar Point Pumping Station
- Delete the Blue Plains Excess Flow improvements, including the four additional primary clarifiers
- Add the new tunnel to Blue Plains
- Add the new ECF and pumping complex at Blue Plains

Recommended Plan

- Include NPDES permit conditions in the consent decree modification that would become effective when the new ECF complex is placed in operation.
- Other changes needed to make the LTCP consent decree consistent with the TN/WW Plan.

**District of Columbia Water and Sewer Authority
Blue Plains Total Nitrogen Removal /
Wet Weather Plan**

APPENDIX A

**Plant Influent Flows and Loads
Technical Memorandum**

Plant Influent Flows and Loads Technical Memorandum

**Prepared for
DC WASA
by**

**EPMC-1
Metcalf & Eddy
Delon Hampton and Associates
PEER Consultants**

Table of Contents

	Page Number
Introduction	1
Blue Plains Service Area	1
Average Annual Plant Influent Flows	3
Maximum Month Plant Influent Flows	3
Average Plant Influent Loads	6
Maximum Month Plant Influent Loads.....	7
Wet Weather Events	8
Summary	12

List of Tables

Table 1. Projected Average Annual Flow to the AWTP at Blue Plains	3
Table 2. Projected Average Annual Blue Plains' Influent Flows and Loads .	7
Table 3. Projected Monthly Blue Plains' Influent Flows and Loads	8

List of Figures

Figure 1. Blue Plains Service Area	2
Figure 2. Average Diurnal Patterns	5
Figure 3. Daily Average Influent Flow 2002/3	5
Figure 4. Projected Blue Plains Influent	10
Figure 5. Blue Plains Hourly Plant Influent Probability	11

Appendix A Hydrologic Conditions

Appendix B 30-Day Rolling Averages of Plant Influent Loads

Introduction

This technical memorandum describes the Blue Plains service area and summarizes the projected flows and loads into the Advanced Wastewater Treatment Plant (AWTP) at Blue Plains from the collection system. The projected influent flows and loads described in this technical memorandum will be used, in conjunction with other information, to assess the adequacy of the existing wastewater treatment plant to meet current and future regulatory requirements.

Blue Plains Service Area

The District of Columbia Water and Sewer Authority (DC WASA) is responsible for providing wastewater treatment service to the District of Columbia as well as significant areas of suburban Maryland and Virginia (Figure 1). The suburban sewer systems in the Blue Plains service area consist of separate sanitary and storm sewers. In the District, the sewer system is comprised of both combined sewers and separate sanitary sewers. A combined sewer carries both sewage and runoff from storms. Modern practice is to build separate sewers for sewage and storm water, and no new combined sewers have been built in the District since the early 1900's. The majority of the area served by combined sewers is in the older developed sections of the District. The area served by combined sewers is approximately one-third of the area of the city.

The Advanced Wastewater Treatment Plant at Blue Plains (Blue Plains) and the wastewater conveyance system to Blue Plains have been evaluated and upgraded many times since their initial construction. A consequence of the historical planning efforts is that the total capacity of the outfall sewers is roughly equivalent to the peak hydraulic capacity through initial treatment at Blue Plains. The Blue Plains Regional Committee comprises representatives of jurisdictions who use Blue Plains. Several legal agreements define the use and cost sharing arrangement of facilities at Blue Plains. A Blue Plains Service Area Facility Plan was completed in December 2003 by the Metropolitan Washington Council of Governments for the Blue Plains Technical Committee and the Blue Plains Regional Committee. The conclusion of that study was that the 370 mgd rated capacity of Blue Plains will be sufficient to provide for the wastewater treatment needs of the service area until the year 2030. The Blue Plains rated capacity shall remain 370 mgd. Therefore, growth in the service area has required "off-loading" of flow from Blue Plains. Loudoun County has a new wastewater treatment plant under construction and the Washington Suburban Sanitary Commission has off-loaded some of its flows from Blue Plains to an expanded Seneca Creek Wastewater Treatment plant.

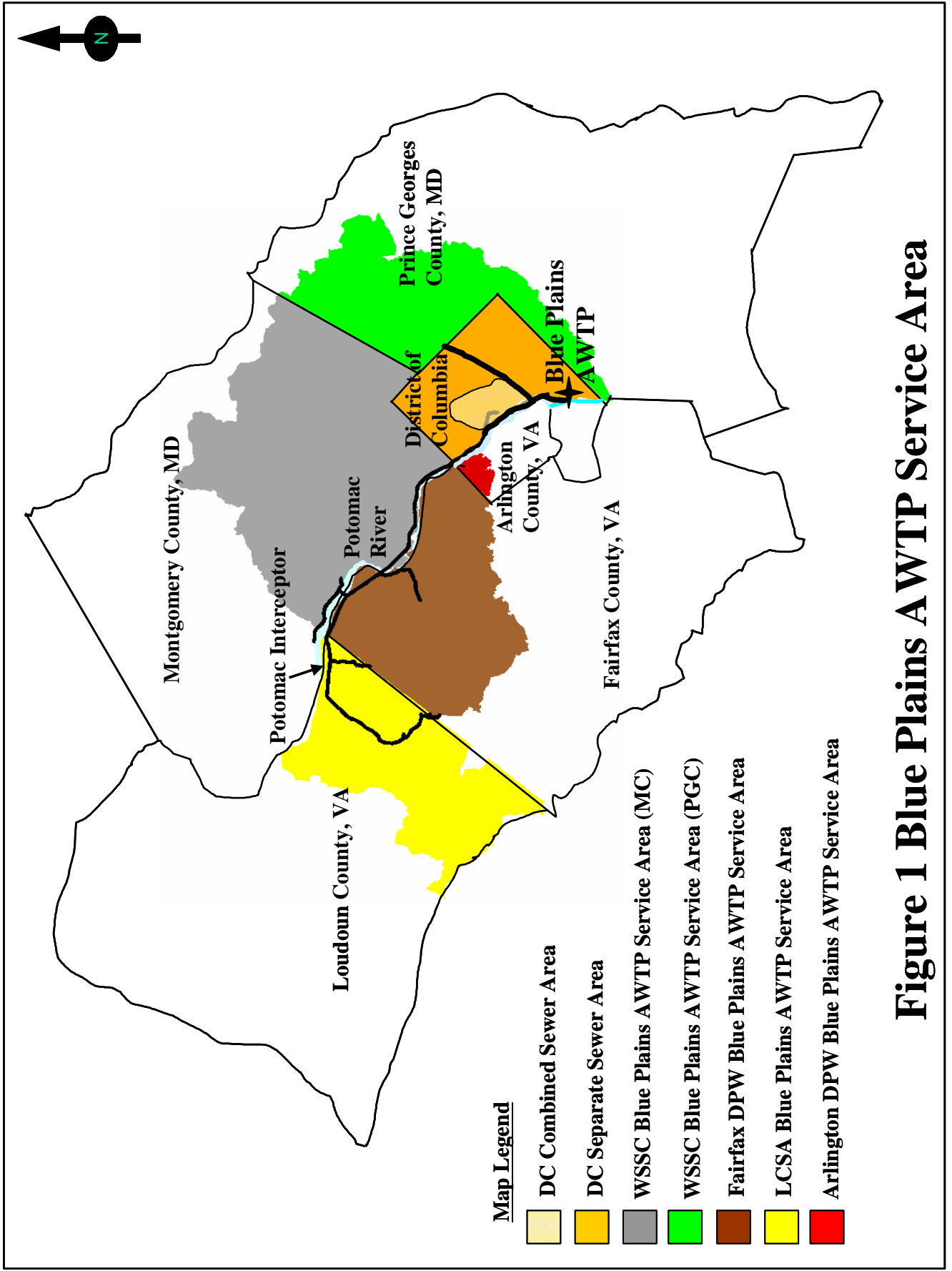

Figure 1 Blue Plains A WTP Service Area

Average Annual Plant Influent Flows

Blue Plains is rated to treat 370 million gallons per day (mgd) on an annual average basis and this capacity has been allocated to the Blue Plains users. Under average hydrologic conditions, projected plant influent is expected to reach 370 mgd, i.e., the rated capacity of Blue Plains, in the year 2030 (MWCOG, 2003). The Blue Plains Regional Committee is presently engaged in negotiations to modify the IMA. This process will address the ultimate capacity of the Blue Plains plant and transmission facilities and the provision of adequate capacity for growth in the Blue Plains Service Area. Table 1 presents the contribution of the planned average annual plant influent flow by jurisdiction. The next section of this memorandum provides detail about plant influent flows during wet weather.

Table 1
Projected Average Annual Flow to Blue Plains

Jurisdiction	IMA Allocation (mgd)	Regional Flow Forecast Model for 2030 ¹ (mgd)
District of Columbia	152.5	171.7
Washington Suburban Sanitary Commission	169.6	150.0
Fairfax County	31.0	31.0
Loudoun County	13.8	13.8
Other Potomac Interceptor Users ²	3.1	3.5
Total	370.0	370.0

¹Blue Plains Service Area Phase I-Facility Planning Study (MWCOG, 2003)

²Other Potomac Interceptor Users are Dulles Airport, the Navy, the Town of Vienna, and the National Park Service

Maximum Month Plant Influent Flows

The average annual rated capacity includes variation in hourly flows due to diurnal fluctuations, variation in seasonal flows due to groundwater table fluctuations, and increases in influent flow due to storm inflow into the collection system. Therefore, it is important to predict plant influent flows during wet weather as well as average annual conditions. Plant influent flow data for recent years was evaluated to predict wet weather plant influent for the future, when Blue Plains reaches its rated capacity

Actual hourly plant influent flow data for “dry” days during the years 2002 and 2003 were evaluated to assess diurnal influent flow patterns. Dry days were identified by the lowest flow days based on average daily flows. Figure 2 shows the average daily plant influent flow for each day from January 1, 2002 through December 31, 2003. The band shown between 275 mgd and 310 mgd includes the “dry” days. During the days in which the flow is above 310 mgd, there are significant inputs to the wastewater flow

from storm flow, infiltration, or both. There were approximately 20 'dry days' for each day of the week.

A characteristic dry weather diurnal pattern for each day of the week was established by averaging the flow values at each hourly increment for the identified dry days. The dry weather diurnal pattern is repeated closely from day to day on weekdays (Monday to Friday). The Saturday and Sunday patterns are similar to each other, but different from the pattern on weekdays. Figure 3 is a plot of the average dry weather diurnal patterns and shows that the increase in flow during the morning hours on weekends lags the increase on weekdays by approximately 2 hours. Based on the data, the diurnal flow factor, i.e. the ratio between the dry weather maximum hourly flows during the day to its average flow, is 1.07 (319 mgd/297 mgd) for weekdays and 1.12 (334 mgd/297 mgd) for weekend days. Therefore, the predicted maximum hourly flow rate during dry weather at the rated capacity of 370 mgd would be 414 mgd (370 times 1.12). The difference between the average flow and the maximum daily dry weather flow is low for Blue Plains because it has a large service area (approximately 725 square miles), it includes a 43 mile interceptor and the maximum diurnal flows from the various sub-sewersheds occur at different times (G&H, 2002). A smaller system would have a higher diurnal flow factor because the maximum diurnal flows from various parts of the collection system could arrive at the plant almost simultaneously.

As seen in Figure 4, average annual flows vary based on hydrologic conditions. Fluctuations in plant influent flow follow the fluctuations in rainfall and groundwater levels.

Inflow and infiltration contribute to flows into the wastewater treatment plant during wet weather. In a combined sewer system, inflow enters the collection system through storm drains and is directly related to precipitation. Infiltration enters the system underground and is related to groundwater and rainfall that infiltrates into the ground. Therefore, the maximum monthly plant influent occurs simultaneous to periods of above average rainfall and high groundwater levels in the sewershed. Information on rainfall probabilities was obtained from the National Oceanic and Atmospheric Administration and was based on data collected at Washington Reagan National Airport during the years 1971-2000 (NOAA, 2002). Information on groundwater levels was obtained from the United States Geological Survey and was based on measurements taken in Fairland, Maryland from 1955-2004 at USGS well 390434076573002 MO Eh 20. This historical information was compared to plant influent flows to identify a maximum month condition.

FIGURE 2

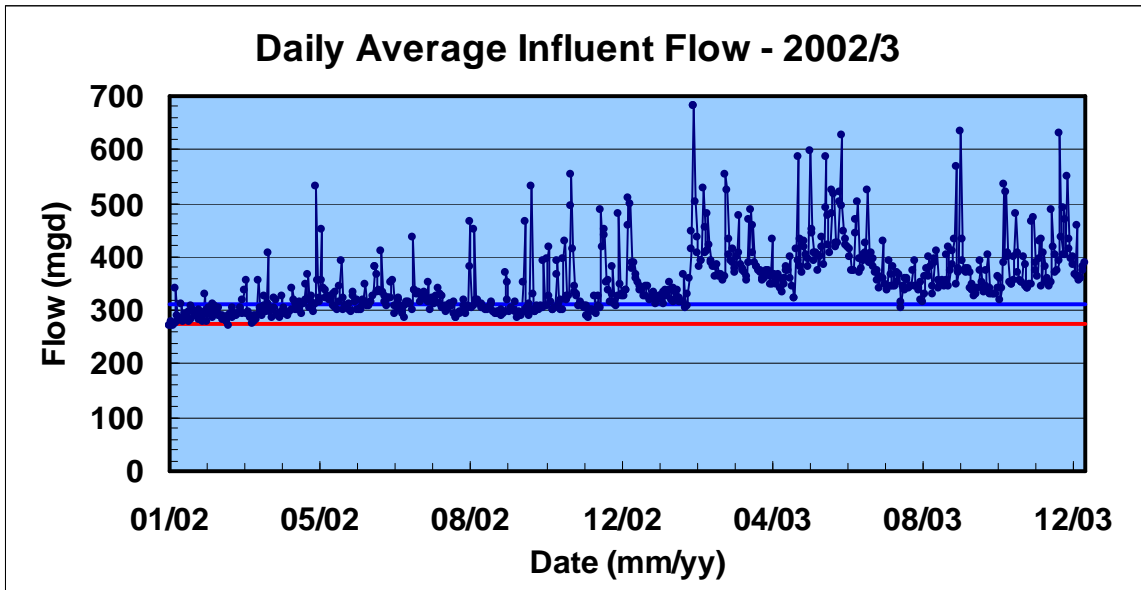
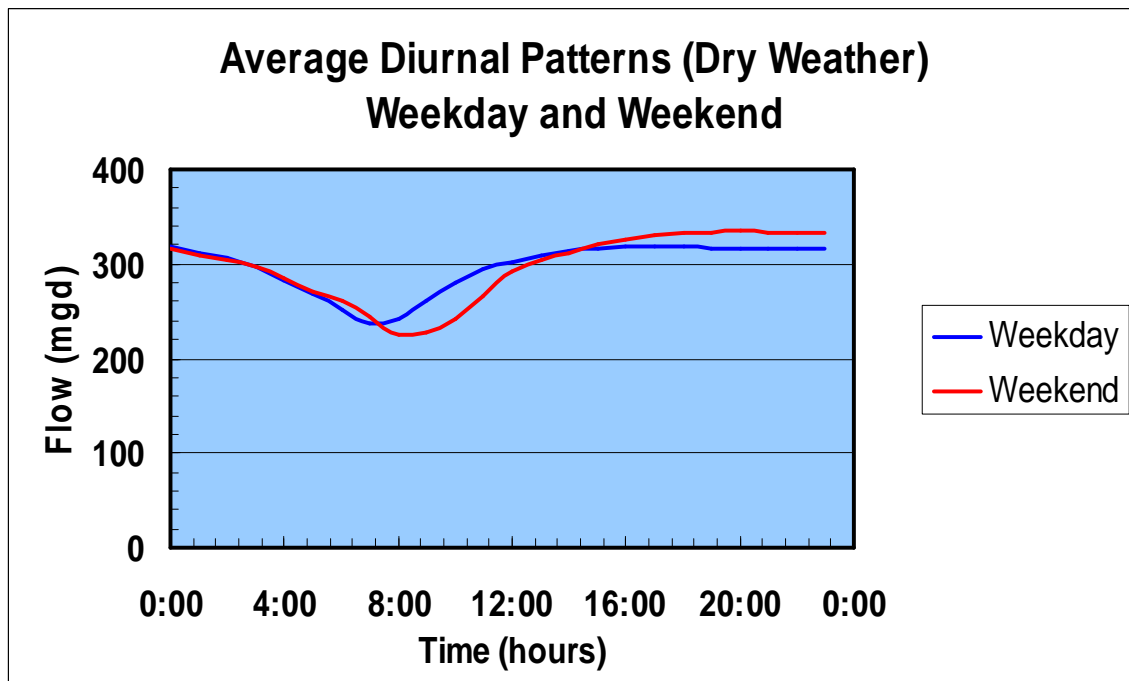

FIGURE 3



Daily influent flows were analyzed for patterns of sustained high flows, i.e., maximum monthly plant influent. Years 2000, 2002 and 2003 were selected since the following range of hydrologic conditions occurred:

- Average
The year 2000 data indicates slightly above average rainfall and average groundwater levels for the year.
- Dry
The year 2002 had significantly below average rainfall and significantly below average groundwater levels for the year.
- Wet
The year 2003 had significantly above average rainfall and significantly above average groundwater levels for the year.

In addition, since this period is closely grouped in time and annual plant influent flows have decreased in the years since 2003, it is reasonable to assume that no significant changes in sanitary flows occurred during the three years that were evaluated. Daily historical influent flow data for the years 2000, 2002 and 2003 were used to compute a peak to average ratio for monthly flow. This value, based on the ratio of the maximum 30-day flow to the average 30-day flow was 1.235. Application of this peak ratio to the plant average annual influent flow capacity of 370 mgd results in a projected maximum month flow of 457 mgd when the plant has reached its design capacity.

Average Plant Influent Loads

Daily plant influent loading data for the years 2000, 2002, and 2003 were evaluated. As mentioned above, these three years were selected because a range of hydrologic conditions (groundwater level and precipitation) occurred during these years and it was assumed that changes in sanitary flows during the three-year period were not significant because the years were close in time and no dramatic changes to population and employment in the Blue Plains service occurred during this time. Table 2-2 presents the average daily value for the historical data set for plant influent flow, total suspended solids (TSS), biological oxygen demand (BOD), total phosphorus (TP) and total Kjeldhal nitrogen (TKN). Increasing the load in proportion to the increase in average annual flow resulted in an estimate of future plant influent average annual load for each constituent.

Table 2
Projected Average Annual Blue Plains' Influent Flows and Loads

Condition	Flow (mgd)	BOD (kips/day)	TSS (kips/day)	TKN (kips/day)	NH3 (kips/day)	TP (kips/day)
Historical Average Annual ¹	341	356	386	71	40	9
Projected Average Annual ²	370	386	419	77	43	9

¹Computed from daily influent values for the years 2000, 2002 and 2003

²Projected average annual flow is the rated capacity of the plant and the projected average loads are prorated based on the ratio of future to current flow.

Maximum Month Plant Influent Loads

As described above, historical data from the years 2000, 2002 and 2003 were used to predict future influent flow patterns at Blue Plains. A peak to average ratio for monthly flow, 1.24, was computed from the historical data. Application of this peak ratio to the plant average annual influent flow capacity of 370 mgd results in a projected maximum month flow of 457 mgd when the plant has reached its design capacity. Probability curves were generated for 30-day rolling averages of plant influent loading of each of the selected constituents (TSS, BOD, TKN, NH₃, TP). The curves were used to define historical maximum monthly values and are included in Appendix A. Rather than choosing the maximum historical value for the monthly loading, values that were not included in the normal distribution were ignored. Specifically, as shown in Appendix A, the point on the high end on the distribution curve where the slope changed was chosen as the maximum monthly historical load for each constituent. Monthly to average ratios were computed and applied to projected average annual values to estimate future monthly loading. Table 3 shows the projected loadings that correspond to the projected maximum month flow. The values presented in Table 3 will be considered the design condition for sustained high flow through the wastewater treatment plant.

Table 3
Projected Monthly Blue Plains' Influent Flows and Loads*

Column Number	(1)	(2)	(3)	(4)	(5)
			(2) ÷ (1)		(3) x (4)
	Historical Values*			Projected Values	
	Average Annual Plant Influent	Maximum Month Plant Influent	Maximum Month/Average Annual Peaking Factor	Projected Average Annual Plant Influent	Projected Maximum Month Plant Influent
Flow	341 mgd	420 mgd	1.24	370 mgd	457 mgd
	Load	Load		Load	Load
Parameter	kips/day	kips/day		kips/day	kips/day
TSS	386	477	1.24	419	518
BOD	356	416	1.17	386	451
TP	9	10.4	1.21	9	11
NH₃	40	52	1.30	43	56
TKN	71	84	1.18	77	91

*Based on daily plant influent data for the years 2000, 2002 and 2003. Since 2003, concentrations of total suspended solids in the plant influent have been increasing to levels greater than the historical data presented in this chart.

Wet Weather Events

Wet weather events result in high peak flows into Blue Plains that are often measured in hours, rather than days or months. As part of the of the Long Term Control Plan (LTCP), Greeley and Hansen Engineers (G&H) developed a model of DC WASA's wastewater collection system that predicts flows in the collection system based on a given base flow and various rainfall conditions. The LTCP assessed conditions for a wet year, a dry year, and an average year. Using the rated capacity of 370 mgd and assuming that the collection system pump stations are fully operational, G&H ran the collection system model and provided EPMC-1 with a 3-year (dry, wet, average) plant hourly influent prediction. This model run was performed in April 2005. Although the model has been updated since that time and the data values are not the most current, the patterns of wet weather flow in both the current model and the 2005 model are similar. Figure 4 shows the hourly output as well as the average daily values for the data.

The current permit requires a four-hour peak flow through all treatment processes at rates up to 740 mgd. The recommended alternative to provide increased nitrogen removal limits the four-hour peak flow through the biological processes to 555 mgd and provides an enhanced clarification facility to treat flows that exceed rates of 555 mgd. DC WASA's Total Nitrogen/Wet Weather

Plan presents results from the latest model runs and predicts loads to the Potomac River as well as river water quality predictions based on the updated models. However, this technical memorandum is limited to Blue Plains' influent flows and loads and uses data from the April 2005 model run to provide a limited discussion of the magnitude of the proposed reduction in 4-hour peak flow through biological treatment. A summary of the analysis follows.

- **Duration of influent flows at rates greater than 555 mgd during a wet weather event.** The wet weather event with the predicted largest peak, i.e. September 26 of the second year, would include 7 hours of influent above the rate of 555 mgd.
- **Frequency of wet weather events during which the peak influent flow rate exceeds 555 mgd.** The wettest month, May of the second year shown on Figure 4, would have 17 wet weather events (defined as plant influent hourly rate greater than 511 mgd) ranging in duration from 1 hour to 22 hours.
- **Portion of time that plant influent is combined sewer flow.** Dry weather flow is flow at influent flow rates up to 511 mgd and occurs 93 percent of the time for an average year. Hourly influent flows at rates up to 555 mgd occur 97 percent of the time for an average year while hourly influent flow rates up to 740 mgd occur 99 percent of the time.
- **Volume of Blue Plains' influent that is combined sewer flows.** For the average of the 3 years, the flows above 511 mgd comprise less than two percent of the total plant influent flow volume, while the flows above 555 mgd are approximately one percent of the total influent flow volume. Figure 5 shows the probability distribution of the hourly flows projected in the April 2005 G&H model.

Figure 4. Projected Blue Plains Influent

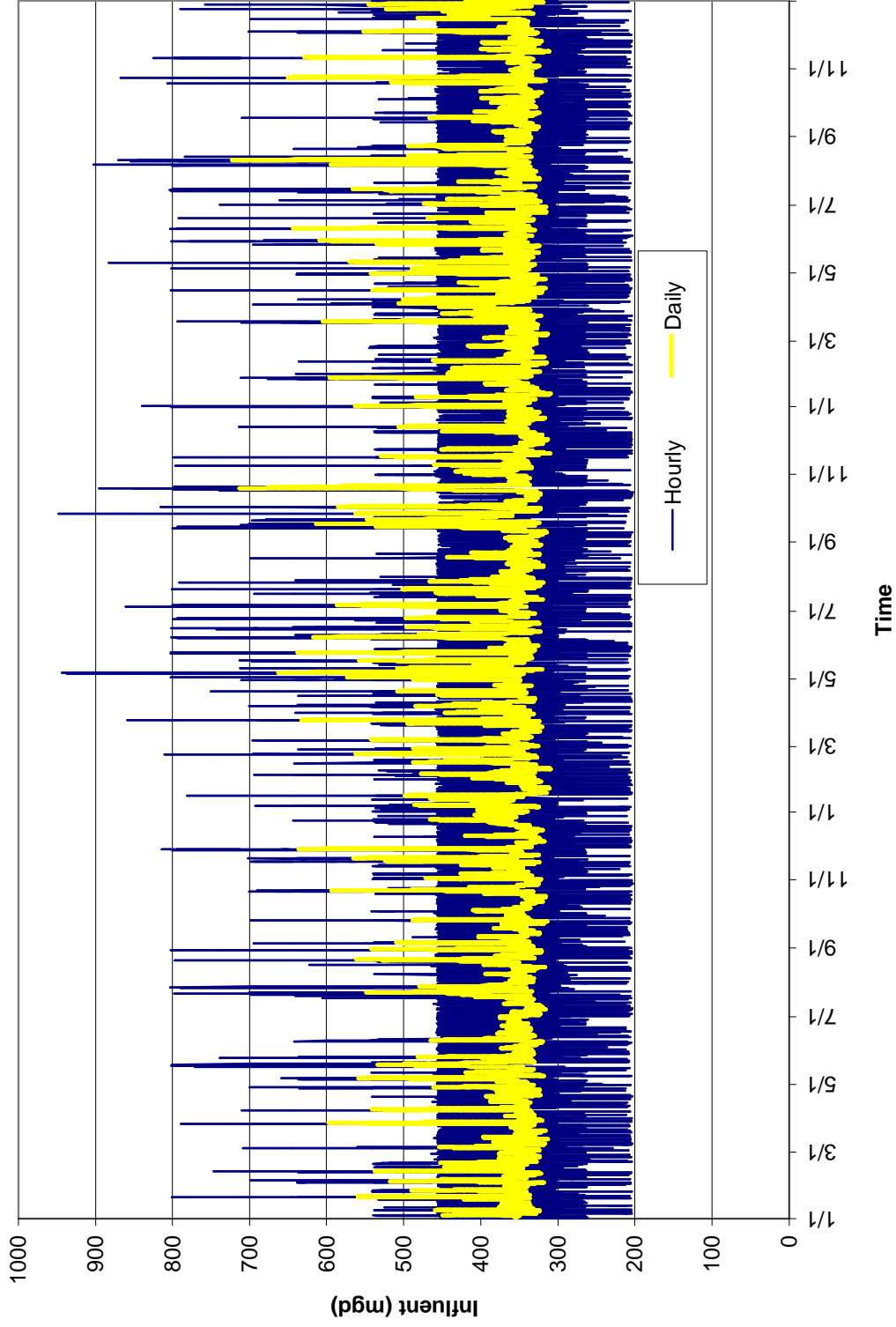
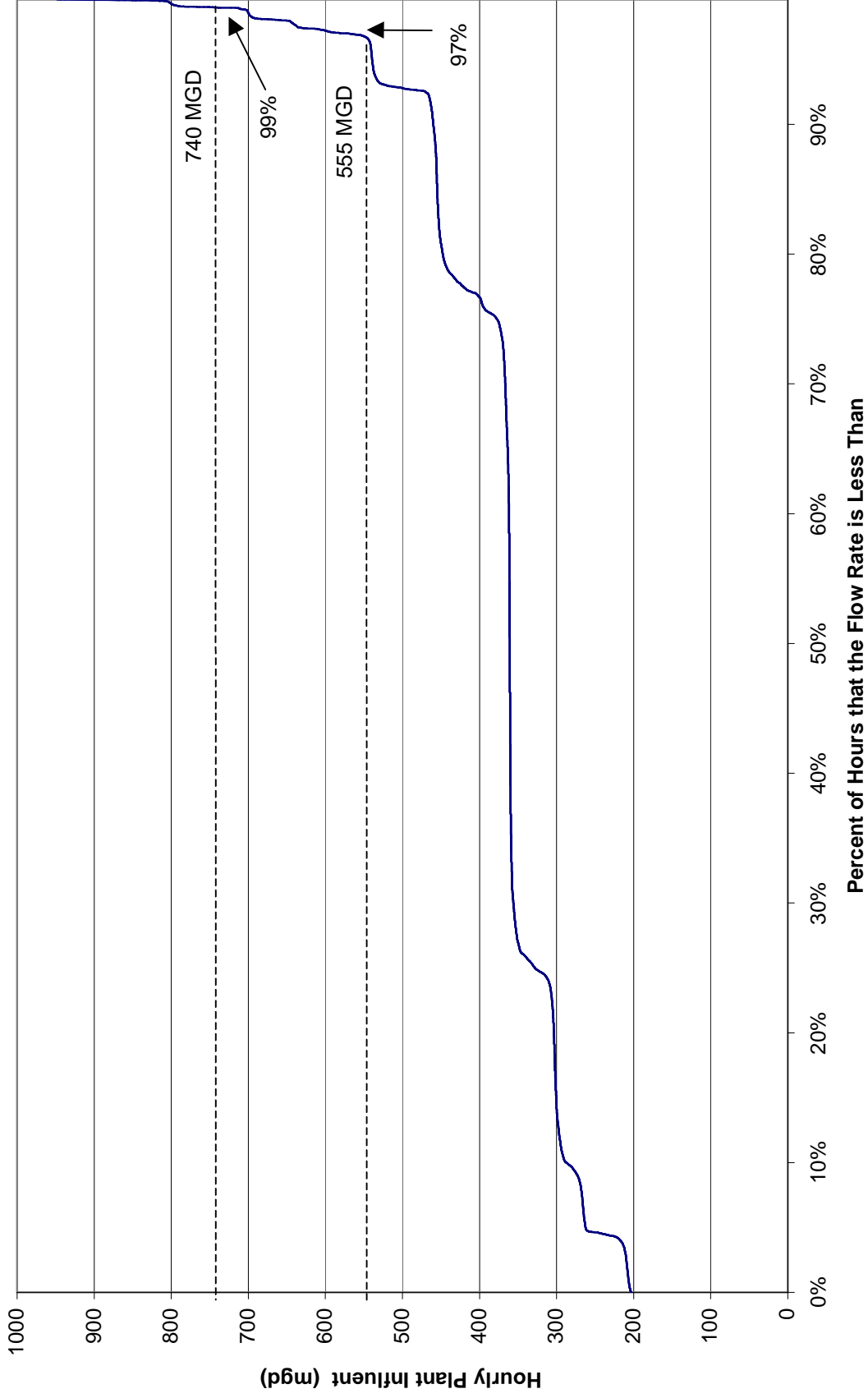

Figure 5. Blue Plains Hourly Plant Influent Probability



Hourly flows up to a rate of 555 mgd comprise > 99% of the total plant influent volume

Summary

The strategic process engineering plan for liquid treatment processes at Blue Plains will not consider expansion of Blue Plains beyond the rated capacity of 370 mgd. The average annual and maximum month flows and loads projected for this rated capacity will be the design conditions used to assess the biological treatment systems (see Table 3).

The four-hour peak flows defined in the permit, i.e. 1076 mgd through initial treatment and 740 mgd through complete treatment, are the design conditions for physical treatment systems because the performance of those systems is related to hydraulic loading rates.

Appendix A

Hydrologic Conditions

Fairland, Maryland 1955-2004
USGS 390434076573002 MO Eh 20

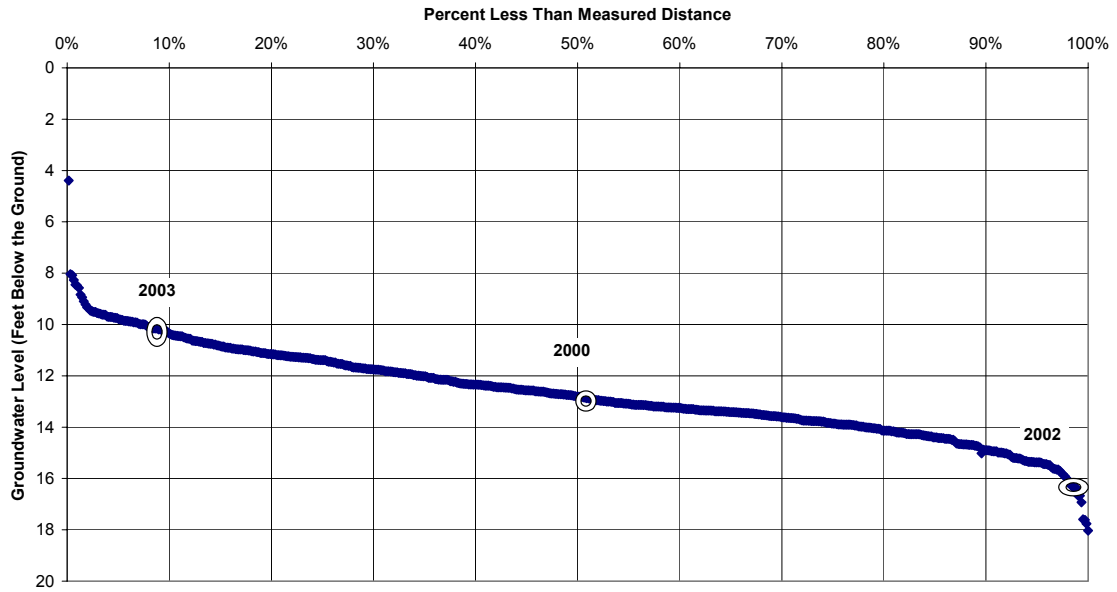

Values shown are 12-month rolling averages ending December 31

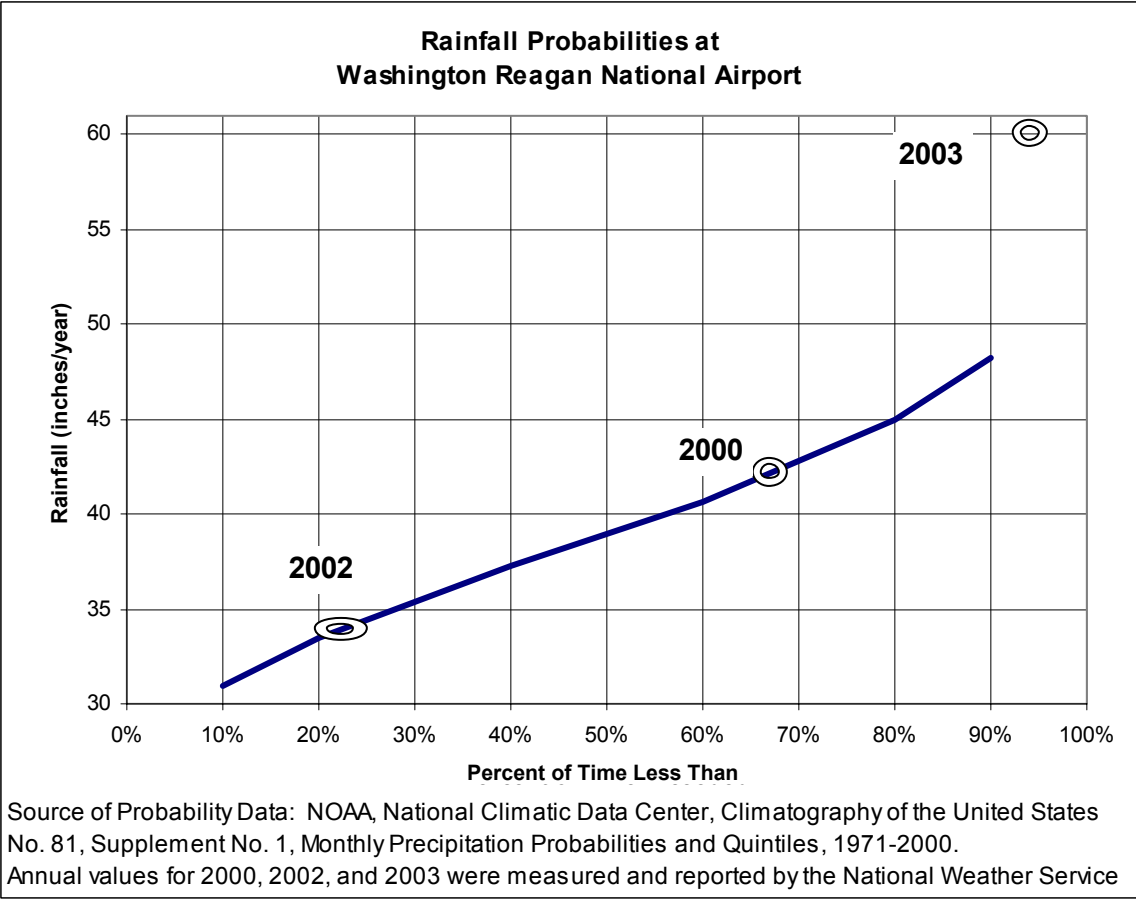

Appendix B
30-Day Rolling Averages
of
Plant Influent Loads

**Blue Plains Influent Total Suspended Solids (TSS)
30-day Rolling Average 2000, 2002, 2003**

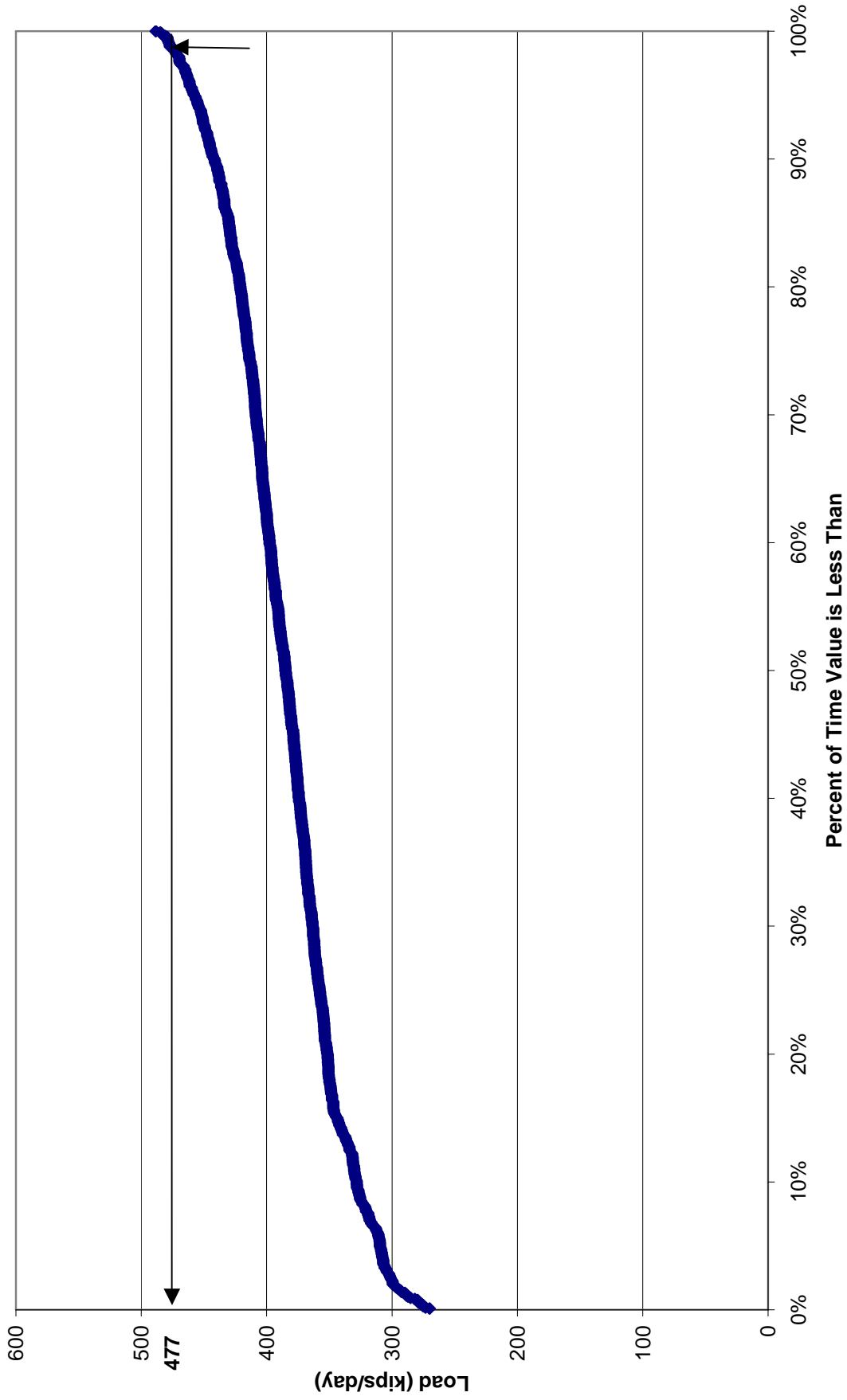

**Blue Plains Influent Biological Oxygen Demand (BOD)
30-day Rolling Average 2000, 2002, 2003**

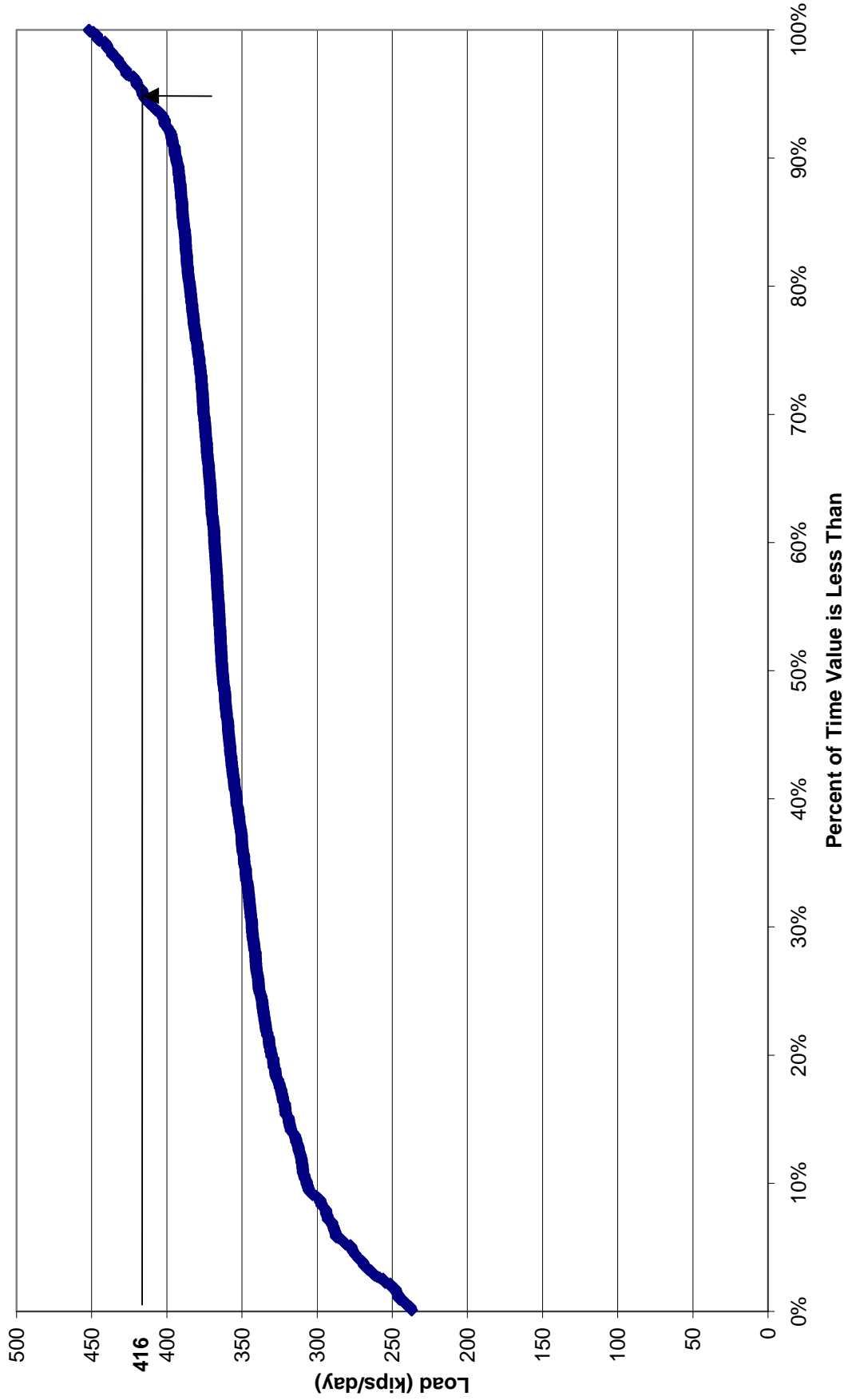

**Blue Plains Influent Total Kjeldhal (TKN) and Ammonia Nitrogen (NH3)
30-day Rolling Average 2000, 2002, 2003**

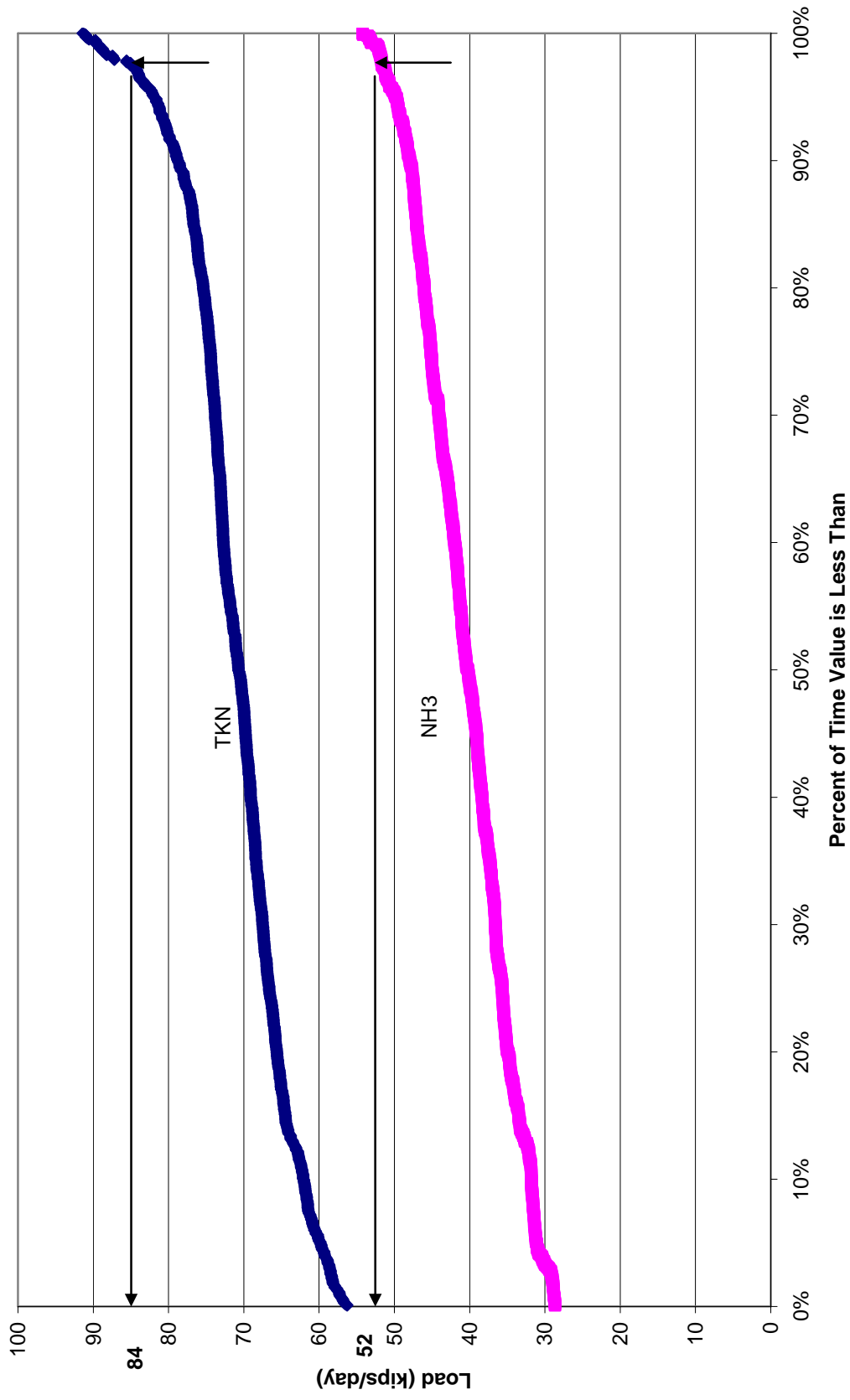

**Blue Plains Influent Total Phosphorus (TP)
30-day Rolling Average 2000, 2002, 2003**

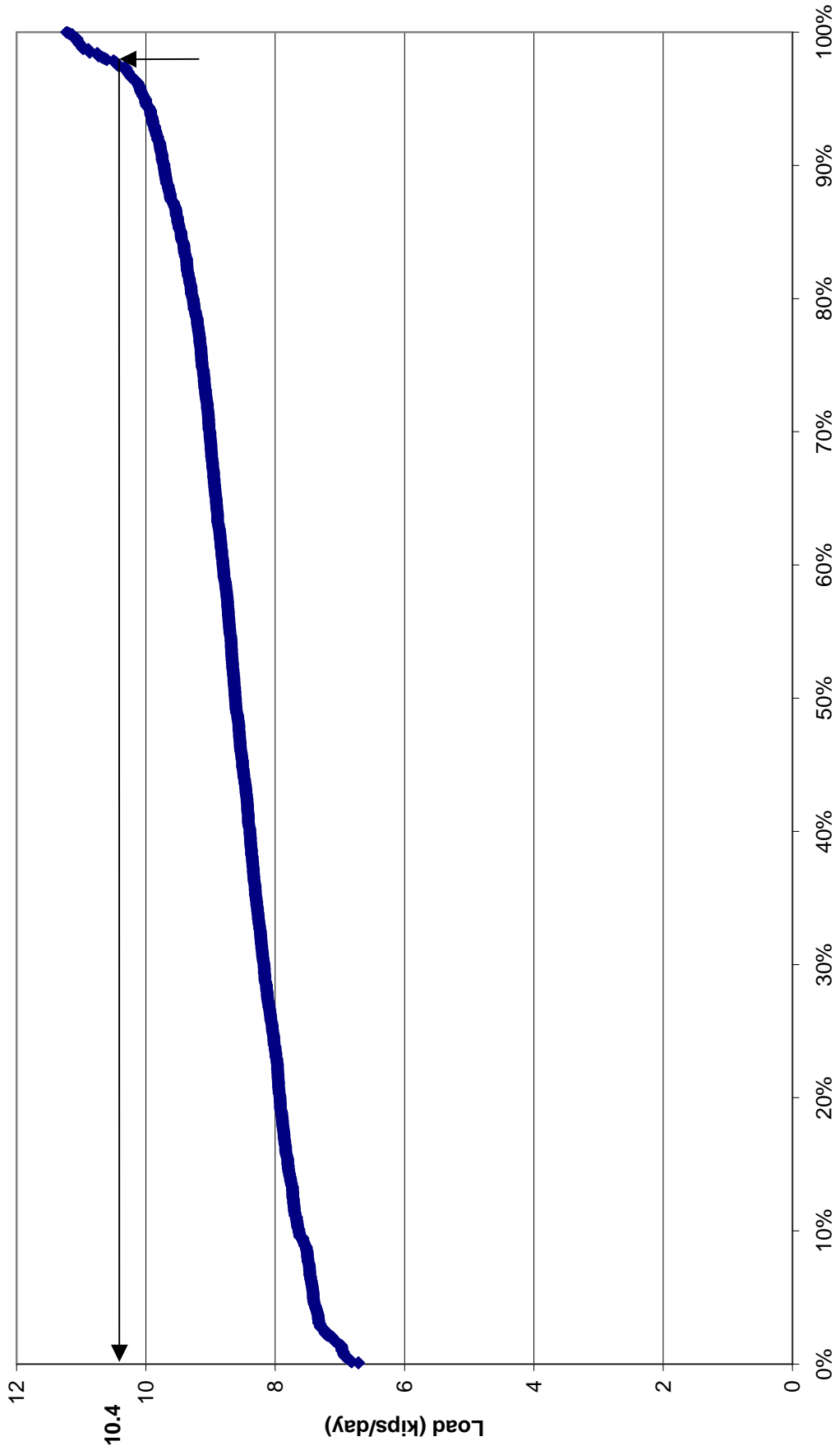

Percent of Time Value is Less Than

Appendix B Historical Monthly Influent Loads
EPMC-1 Technical Memorandum on Plant Influent Flows and Loads
Prepared for DC WASA

B-4

**District of Columbia Water and Sewer Authority
Blue Plains Total Nitrogen Removal /
Wet Weather Plan**

APPENDIX B

**Blue Plains Strategic Plan Process
Modeling Technical Memorandum**

Blue Plains Strategic Plan Process Modeling Technical Memorandum

**Prepared for
DC WASA
by**

**EPMC-1
Metcalf & Eddy
Delon Hampton and Associates
PEER Consultants**

Table of Contents

	Page Number
Introduction	1
Design Condition and Approach.....	1
Modeling Design Criteria.....	3
Baseline Model Development	4
Baseline Model Configuration.....	4
Model Physical Dimensions.....	7
Dissolved Oxygen (DO) Setpoints	8
Return Activated Sludge Flows.....	8
Centrate Flow Characteristics.....	9
Mathematical Models Used	9
Design Scenarios	10
Scenario 1: Baseline Condition.....	10
Scenario 2: Baseline + Centrate Treatment Facility	11
Scenario 3. Baseline + Centrate Treatment + Additional Reactors	14
TN Discharge Levels at Average Flow	16
Modeling Approach and Design Criteria	16
Monthly Temperatures	16
Design Scenarios.....	17
The effect of the anoxic methanol utilizers kinetics on TN removal.....	23
Considerations and Recommendations.....	24

Table of Contents

Page
Number

List of Tables

Table 1. Dimensions of Baseline Model Main Processes	7
Table 2. Baseline Model DO Setpoints in the Main Processes	8
Table 3. Baseline Model RAS Flow Rates	8
Table 4. Estimated Centrate Flow Characteristics	9
Table 5. Design Average Annual Flows and Loads	16
Table 6. TN Discharge Results including Ammonia and Nitrate	18

List of Figures

Figure 1. BPAWTP 2002 calibration model	2
Figure 2. Baseline Model Configuration	5
Figure 3. Scenario 1 Sensitivity Analysis Plot	10
Figure 4. Scenario 2. Sensitivity Analysis Plot (50% seeding efficiency)	11
Figure 5. Scenario 2. Sensitivity Analysis Plot (0% seeding efficiency)	12
Figure 6. Baseline + CTF Model Configuration in BioWin	13
Figure 7. Scenario 3 Sensitivity Analysis Plot	14
Figure 8. All Scenarios Sensitivity Analyses Plots	15
Figure 9. Average Monthly Wastewater Temperatures at Blue Plains	17
Figure 10. Minimum Average Monthly Wastewater Temperatures	17
Figure 11. Scenario 2.a Simulated Monthly Effluent TN	20
Figure 12. Scenario 2.b Simulated Monthly Effluent TN	20
Figure 13. Scenario 3.a Simulated Monthly Effluent TN	21
Figure 14. Scenario 3.b Simulated Monthly Effluent TN	21
Figure 15. Simulated Monthly Effluent TN without Digestion Facility	22
Figure 16. Simulated Monthly Effluent TN with Additional Reactors but no Digestion Facility	23

INTRODUCTION

The District of Columbia Water and Sewer Authority (DCWASA) has requested from EPMC-1 to perform strategic process engineering to evaluate and develop a plan for improvements that would address potential future regulatory requirements for the treatment of wastewater at the Blue Plains Advanced Wastewater Treatment Plant (BPAWTP).

EnviroSim, Inc., the owner and the developer of BioWin, in collaboration with Metcalf & Eddy, has prepared a comprehensive calibrated model of BPAWTP for DCWASA. The model was calibrated using the actual plant quality data for the full year of 2002. Figure 1 shows the configuration of the calibrated model in BioWin. The objective of developing this model was to use it as a tool to optimize plant operations as well as to serve as the base model to develop and test future design alternatives and scenarios. EnviroSim has recommended, in their report, further investigation for the nitrification and denitrification rate parameters to improve the model performance to better predict the actual plant performance. DCWASA began a series of bench scale laboratory batch tests to verify and refine the values of these parameters used in the model.

EPMC-1 used the 2002 calibration model, which was finalized and delivered by EnviroSim, Inc. to DCWASA in February 2005, to develop design alternatives and scenarios to support the strategic process engineering plan, based on a defined design condition. The alternatives and scenarios were selected to improve plant performance regarding effluent total nitrogen (TN) levels for Outfall 002. After the alternatives and scenarios were developed meeting the requirements of the defined design condition, further investigation for monthly effluent TN levels was performed to assess the plant performance on an annual basis.

DESIGN CONDITION AND APPROACH

In all design alternatives, the maximum monthly flow and the maximum monthly loads of organics, nitrogen, and phosphorus constituents were used for modeling. The design flows and loads are discussed in detail in the Blue Plains Influent Flows and Load Technical Memorandum. The design temperature selected was 12 °C based on the historical data of monthly rolling averages throughout the years 2002 through 2004. Selecting the maximum monthly flow coupled with the lowest 30-day rolling average temperature was chosen to represent the worst-case scenario, which is suitable for the strategic planning effort, especially under the stringent effluent TN limitations. The concept revolves around the fact that in order to meet stringent annual TN discharge limit, the plant must be designed to reliably meet this limit throughout the year due to the small range of acceptable degradation in its performance.

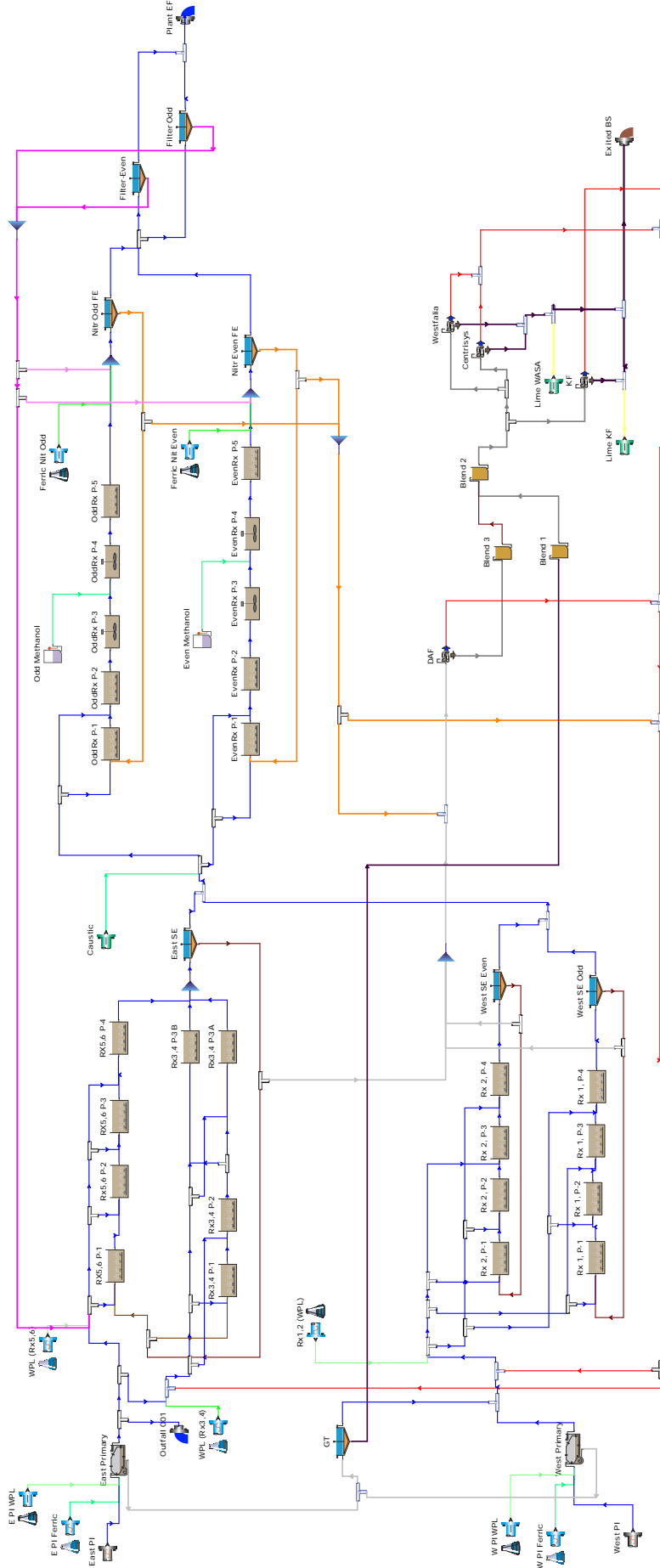

(EnviroSim, Inc., 2005

Figure 1
BPAWTP 2002 calibration model

Several scenarios were evaluated for DC WASA's strategic planning to meet the potential future TN discharge permit limits via Outfall 002. The modeling approach was based on a sequential "step by step" performance enhancement technique where potential plant improvements were introduced to the model to enhance TN removal. The scenarios that were modeled and evaluated are as follows:

- **Scenario 1:** The baseline model.
- **Scenario 2:** Scenario 1 with the integration of a side stream centrate treatment facility (CTF) to treat the additional load of ammonia in the recycle flows from solids digestion process.
- **Scenario 3:** Scenario 2 with the addition of 4 new biological nitrogen removal (BNR) reactors.

Modeling Design Criteria

The following are the design criteria that were used in all model runs for the design scenarios mentioned above:

- 1- Influent Design parameters:
 - a. Design Flow = Maximum Month Flow, MGD = **457**
 - b. Total suspended solids, mg/L = **136**
 - c. Total carbonaceous BOD, mg/L = **118**
 - d. Total Kjeldahl Nitrogen (TKN), mg N/L = **24**
 - e. Total phosphorus (TP), mg P/L = **2.99**
- 2- The minimum design temperature, °C = **12**
- 3- The Mixed liquor suspended solids (MLSS) concentration in the secondary and nitrification/denitrification reactors was maintained at **2000±50** mg/L.
- 4- The total suspended solids (TSS) percent removal in the east and west primary clarifiers was set to **55%**.
- 5- The TSS concentration in the east and the west secondary clarifiers' effluent was maintained at **40±1** mg/L.
- 6- The methanol dosing rate was used such that nitrate_N concentration in the anoxic stage "Nit_P5-B" was maintained at **0.5±0.1** mg N/L.
- 7- The ferric chloride dosing rate was used to maintain a TP concentration in the primary clarifiers effluent around **1 – 2** mg P/L, and in the secondary reactors effluent around **0.1 – 0.3** mg P/L.

In all runs, the plant effluent organic nitrogen was approximately 1.7 mg N/L, which includes soluble organic nitrogen portion of approximately 1.3 mg N/L.

BASELINE MODEL DEVELOPMENT

The baseline condition refers to plant facilities existing in the year 2005 as well as future facilities that are identified in DC WASA's FY 2004 Capital Improvement Plan (CIP). The specific projects in the CIP are comprised of the secondary and the nitrification/denitrification process upgrade projects, the addition of new anaerobic digesters, and rehabilitation of collection system pumping stations. These projects include the following major improvements:

- 1- The secondary facilities upgrade project:
 - a. Secondary Reactors 5 and 6 are doubled in volume for a total secondary reactor volume of approximately 32.5 MG; and
 - b. fine bubble diffusers are installed in all secondary reactors.
- 2- The nitrification/denitrification facilities upgrade project:
 - a. modifying the reactors configuration to provide for serpentine plug flow by dividing stages 1, 3, & 5; and
 - b. fine bubble diffusers are installed in the oxic stages of the reactors.
- 3- The addition of new egg shaped anaerobic digesters to stabilize biosolids from the dissolved air flotation (DAF), and the gravity thickener (GT) processes.

Baseline Model Configuration

The baseline model configuration mimics the future plant as described above. It was developed based on the 2002 calibration model. However, the baseline model configuration was simplified by reducing the number of process elements. This accelerated the simulation speed of the model without affecting modeling accuracy. Figure 2 shows the baseline model configuration in BioWin.

The following modifications were applied to the 2002 calibration model to develop the baseline model:

- 1- The east and west secondary process upgrades were implemented in the baseline model:
 - a. The west secondary process, which comprises Reactors 1 and 2, was represented as 4 reactors in series to reflect the 4 stages.
 - b. The west secondary clarifiers were combined into one clarifier.
 - c. The east secondary process, which comprises Reactors 3, 4, 5, and 6, was represented as 4 reactors in series to reflect the 4 stages. However, the flow splits after the 3rd reactor such that 75% goes to the east secondary clarifiers and 25% continues to the 4th reactor to reflect the fact that last two stages in Reactors 3 and 4 are in parallel.
 - d. The increase in the volume of Reactors 5 and 6 was implemented into the volume of the east secondary reactors.
 - e. The DO levels were set as shown in table 1 to mimic the effect of the fine bubble diffusers.

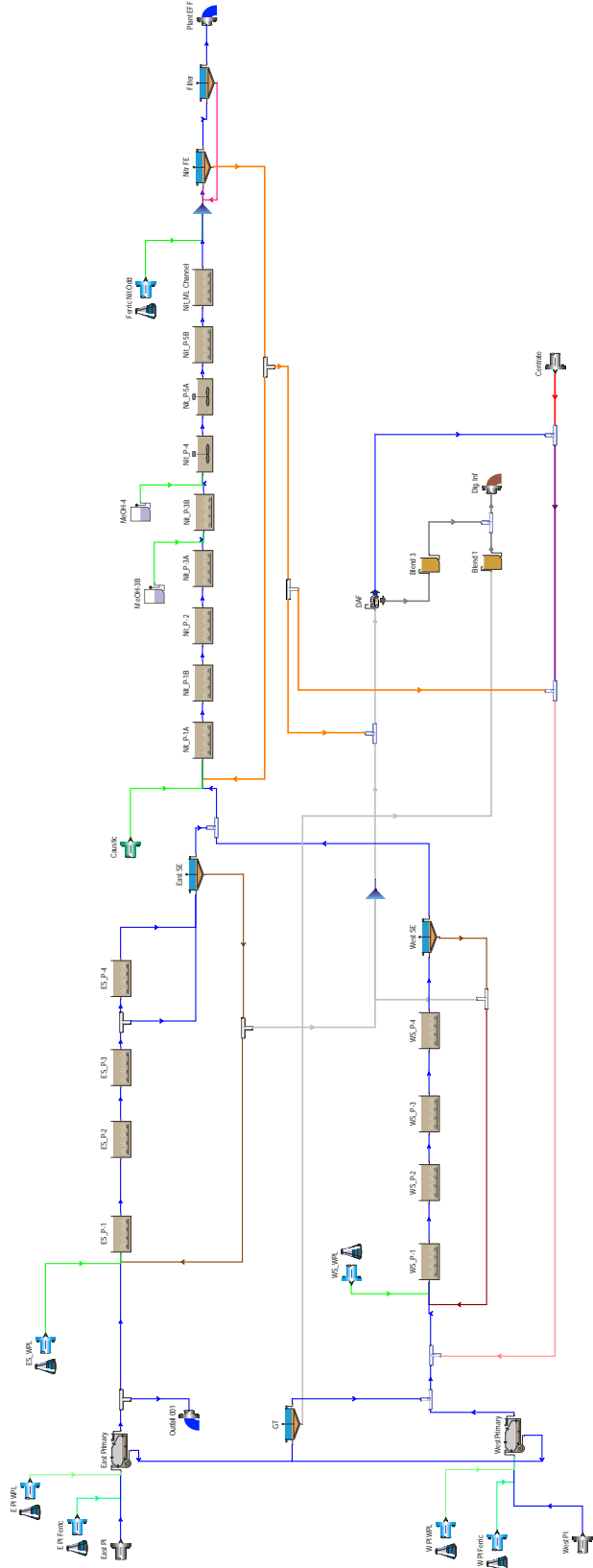

Figure 2.
Baseline Model Configuration in BioWin.

- 2- The nitrification/denitrification process upgrades were implemented in the baseline model:
 - a. The odd and even trains were combined in one main train.
 - b. The number of reactors in the main train was changed from 5 to 8 to reflect the new plug flow, serpentine reactor.
 - c. Because the nitrification/denitrification mixed liquor effluent channel carries a significant volume, and air diffusers are to be installed into this channel, it was introduced into the model as an additional aerated reactor volume following the nitrification/denitrification reactors.
 - d. The DO levels were set as shown in Table 2 to mimic the effect of the fine bubble diffusers.

- 3- The addition of new anaerobic digesters:
 - a. The intent of this effort was to model the effect and treatment of the load from the digester centrate recycle and not to model the digester operation. An estimated centrate recycle flow was introduced into the model where it feeds into the solids process building (SPB) recycle line. The predicted characteristics of the centrate are shown in the centrate section in Table 4.
 - b. The dewatering facilities were eliminated in the baseline model.

- 4- The primary clarifiers removal efficiencies were adjusted to 60% for plant influent flows equivalent to 370 mgd and 55% at maximum monthly plant influent flows, i.e., 457 mgd. These values are based on stress testing on the primary clarifiers that was done in 2005.

- 5- All reactors were operated in a plug flow operation mode, i.e. no step feeding.

Model Physical Dimensions

The following table lists the elements in the main treatment processes, i.e. secondary and nitrification/denitrification, after introducing the modifications to the calibration model.

PROCESS	ELEMENT NAME	ELEMENT TYPE	VOLUME (MG)	DEPTH (ft)	AREA (ft²)
East Secondary	ES_P-1	Bioreactor	5.13	15.0	45,720
	ES_P-2	Bioreactor	5.13	15.0	45,720
	ES_P-3	Bioreactor	8.12	15.0	72,400
	ES_P-4	Bioreactor	2.14	15.0	19,040
	East SE	Ideal Clarifier	22.2	12.0	248,040
West Secondary	WS_P-1	Bioreactor	2.99	15.0	26,680
	WS_P-2	Bioreactor	2.99	15.0	26,680
	WS_P-3	Bioreactor	2.99	15.0	26,680
	WS_P-4	Bioreactor	2.99	15.0	26,680
	West SE	Ideal Clarifier	21.4	12.0	238,500
Nitrification/de-nitrification	Nit_P-1A	Bioreactor	5.36	30	23,904
	Nit_P-1B	Bioreactor	5.36	30	23,904
	Nit_P-2	Bioreactor	10.73	30	47,808
	Nit_P-3A	Bioreactor	5.36	30	23,904
	Nit_P-3B	Bioreactor	5.36	30	23,904
	Nit_P-4	Bioreactor	10.73	30	47,808
	Nit_P-5A	Bioreactor	5.36	30	23,904
	Nit_P-5B	Bioreactor	5.36	30	23,904
	ML Channel	Bioreactor	5.45	20	36,428
Nitr FE	Ideal Clarifier	84.9	15.5	732,464	

All processes other than what are mentioned above remained the same as they exist in the 2002 calibration model.

Dissolved Oxygen (DO) Setpoints

The dissolved oxygen levels in all reactors were set as constant values (mg/L) based on estimated design values. Table 2 presents the DO setpoints in all reactors

Process	Reactors Name	Aeration Status	DO Setpoint (Mg/L)
East Secondary	ES_P-1	Oxic	2.0
	ES_P-2	Oxic	2.0
	ES_P-3	Oxic	2.0
	ES_P-4	Oxic	2.0
West Secondary	WS_P-1	Oxic	2.0
	WS_P-2	Oxic	2.0
	WS_P-3	Oxic	2.0
	WS_P-4	Oxic	2.0
Nitrification/denitrification	Nit_P-1A	Oxic	3.0
	Nit_P-1B	Oxic	3.0
	Nit_P-2	Oxic	3.0
	Nit_P-3A	Oxic	3.0
	Nit_P-3B	Deoxic	1.0
	Nit_P-4	Anoxic	Unaerated
	Nit_P-5A	Anoxic	Unaerated
	Nit_P-5B	Oxic	3.0
	ML Channel	Oxic	2.0

Returned Activated Sludge (RAS) Flows

The following table summarizes the RAS flows used for each process.

Clarifiers Set	RAS Flow Rate (MGD)
East Secondary	115
West Secondary	92
Nitrification/denitrification	381

Centrate Flow Characteristics

The term “centrate” refers to the flow stream that will be produced by the centrifuge dewatering of the anaerobically digested biosolids. The centrate characteristics were estimated based on typical values that were provided by EPMC-4 for anaerobically digested biosolids using the TPAD-A digester mode, and augmented, as needed, with Metcalf & Eddy experience in New York City with centrate recycles.

PARAMETER	DIGESTED SLUDGE (EPMC-4)	CENTRATE (INFLUENT CRITERIA)
COD (mg/L)		1775
Soluble inert COD (mg/L)		100
Particulate inert COD (mg/L)		500
Particulate biodegradable COD (mg/L)		475
VFA (mg COD/L)	700	700
Particulate biodegradable organic N (mg N/L)		47.5
Soluble biodegradable organic N (mg/L)		100
Ammonia (mg N/L)	1600	1600
Soluble inert organic N (mg N/L)		10
Total phosphorous (mg/L)		100
Soluble PO4 (mg P/L)		50
Total suspended solids (mg/L)	27,000	1000
Volatile suspended solids (mg/L)	16,200	650
Inert suspended solids (mg/L)	10,800	350
Alkalinity (mmol/L)		111

Mathematical Models Used

BioWin v2.1 provides several options for model selection to best describe the relevant processes on the plant and simplify those that are not important. Therefore, the following models were selected:

- 1- BioWin Activated Sludge - Digester Model (ASDM).
- 2- pH calculation.
- 3- Metal precipitation reactions for metal phosphates and hydroxides using Ferric.
- 4- Oxygen modeling where the model does not assume immediate response to changes in DO stepoints.
- 5- Phase separation in settlers, thickeners, and DAFs is based on ideal separation (percent removal model).

Design Scenarios

In this section, the modeling approach used to evaluate the plant performance under three design scenarios are discussed in detail along with presentations of the results. The three scenarios are:

1. Scenario 1: Baseline Condition
2. Scenario 2: Baseline + Centrate Treatment Facility (CTF)
3. Scenario 3: Baseline + Centrate Treatment Facility (CTF) + Additional Reactors

Scenario 1: Baseline Condition

Steady state simulations were run using the baseline model to evaluate the plant performance for Outfall 002 TN levels under the plant baseline condition as described previously. These simulations utilized various nitrification/denitrification MLSS (or $MLSS_{Nit}$) concentrations to assess the robustness of process performance against potential changes in $MLSS_{Nit}$ concentrations during daily operation. In all scenarios, the model was run at the design maximum monthly flow of 457 MGD, and minimum temperature of 12 °C to mimic the worst case scenario. The steady state simulation results in terms of effluent TN were plotted against the $MLSS_{Nit}$ levels to create a "Sensitivity Analysis" curve as shown in Figure 3. The figure shows that at a design $MLSS_{Nit}$ concentration of 2,000 mg/L, the plant can marginally achieve effluent TN level of approximately 10 mg/L. However, since the design condition represents the worst case scenario, it is projected that the plant can achieve an annual TN level of 7.5 mg/L because TN removal would significantly increase in the warmer months.

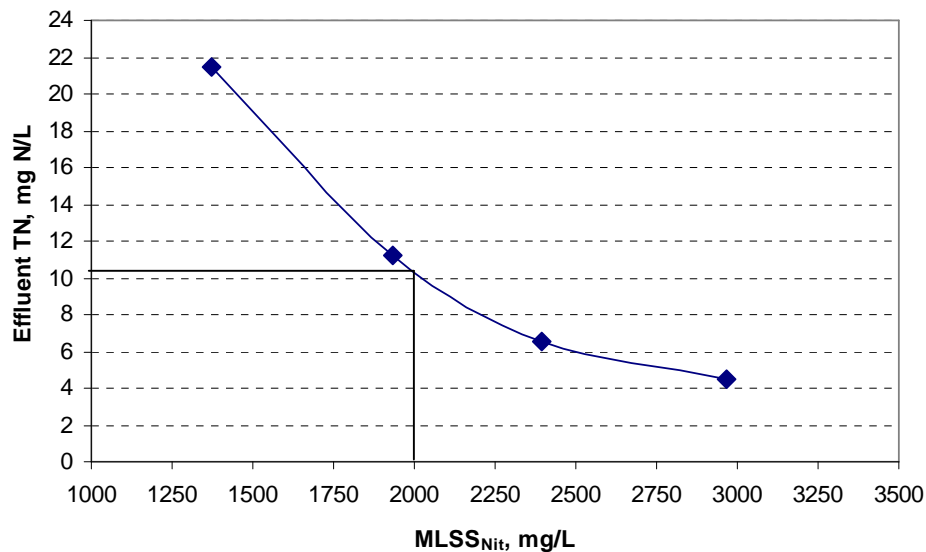
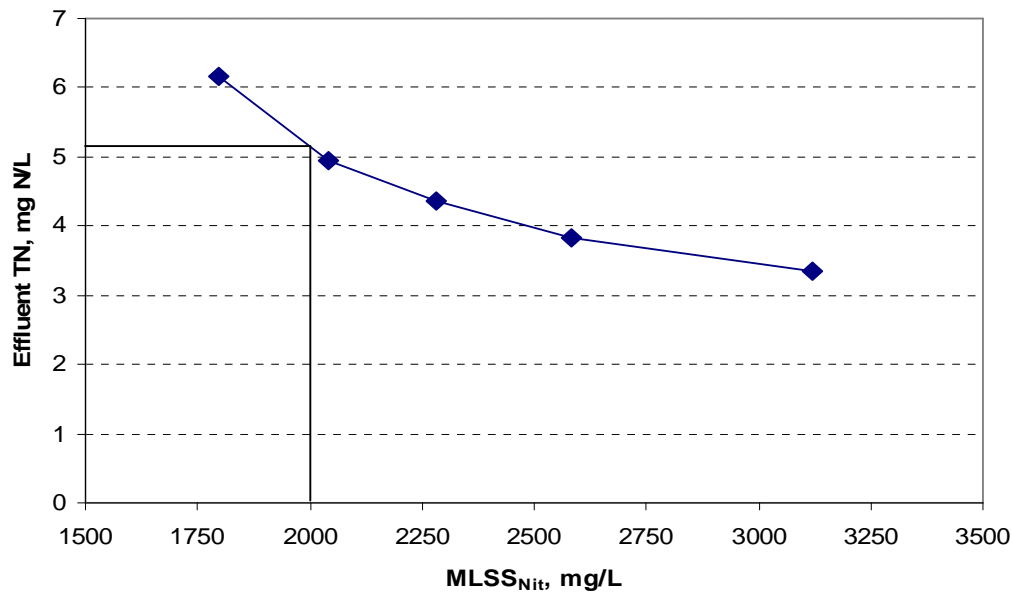

Figure 3.
Scenario 1 Sensitivity Analysis

Scenario 2: Baseline + Centrate Treatment Facility (CTF)

In this scenario, modifications to the baseline model configuration were performed to introduce the Centrate Treatment Facility (CTF) into the model. Figure 6 shows the configuration in BioWin. The centrate flow would be treated separately to reduce ammonia and nitrate levels, and the treated effluent would be sent to the head of the nitrification/denitrification process. The seeding efficiency of the CTF must be determined by piloting, and is dependant on the type of centrate treatment process utilized. The seeding efficiency refers to the fraction of the active biomass leaving the CTF that can perform conventional nitrification or denitrification in the main nitrification/denitrification stream. For the evaluation purposes of this scenario under seeding condition, the seeding efficiency was assumed to be **50%** for both: Nitrifiers and Denitrifiers. Figure 4 shows the results of the sensitivity analysis plot for this scenario. The figure shows that at the design condition, the plant can achieve a marginal effluent TN level of approximately 5 mg N/L. Based on this scenario, a significant improvement in plant performance in terms of reducing



effluent TN levels is expected.

Figure 4
Scenario 2 Sensitivity Analysis Plot
(50% seeding efficiency)

However, the improvement is directly related to seeding efficiency from the CTF. If the CTF does not provide seeding of the main process, but the treated centrate is still directed to the nitrification/denitrification facility, the performance will degrade. In this case where no seeding is provided by the CTF, its effluent (containing inert solids) should be directed to the secondary process. Figure 5 shows the sensitivity plot for the addition of the CTF scenario, but with no seeding efficiency from the treated centrate (0% seeding efficiency) and the inert solid being sent

to the Nitrification/Denitrification process. Under this scenario, the plant performance is comparable to its performance in Scenario 1 (baseline condition) because of the inactive solids that will negatively affect the process performance. This shows how sensitive the plant performance is to seeding efficiency.

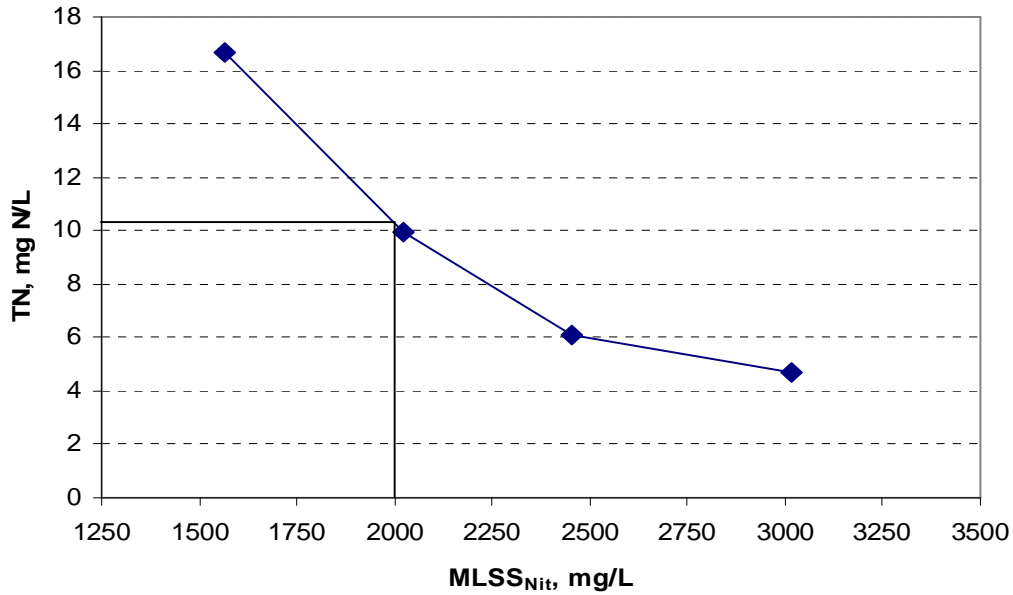

Figure 5.
Scenario 2 Sensitivity Analysis Plot
(0% seeding efficiency)

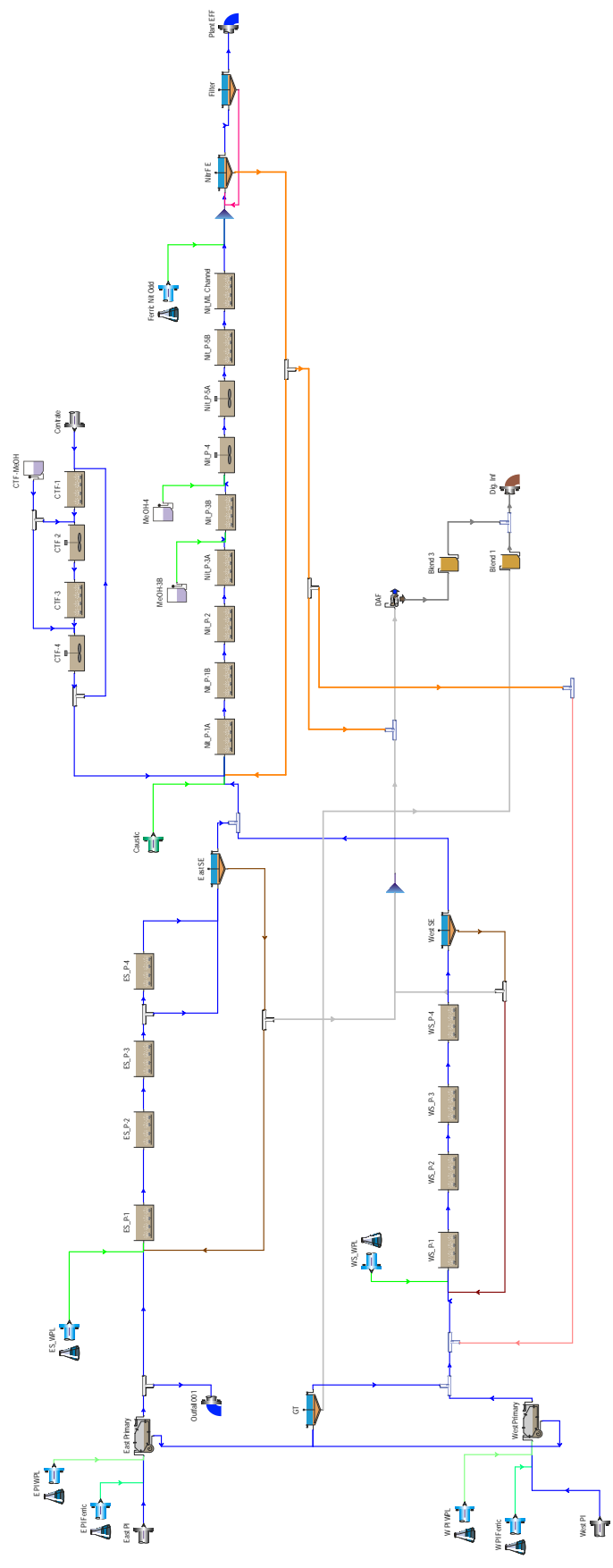

Figure 6
Baseline + CTF Model Configuration in BioWin.

Scenario 3: Baseline + CTF + 4 Additional BNR Reactors

Further improvement to plant performance would be expected by increasing the capacity of the nitrification/denitrification process reactors. The addition of 4 BNR reactors would provide for a total of 16 BNR reactors. The conversion of the nitrification process to a BNR process, nitrification and denitrification, resulted in a reduction in the overall nitrification dedicated oxic volume by approximately 30% to 40% due to the replacement of 1.5 or 2 oxic stages with anoxic stages for denitrification. To compensate for the loss of this nitrification volume, 4 additional BNR reactors should be adequate. Therefore, a volume of 4 additional BNR reactors was implemented in the model scenario for evaluation. The CTF seeding efficiency used in this scenario was 50%, the same as in scenario 2. Figure 7 shows the results of the sensitivity analysis of the $MLSS_{Nit}$ versus effluent TN levels for this scenario. At design conditions, the plant is capable of achieving a marginal effluent TN level of about 3.5 mg/L. Since this run represents the worst case scenario, it is projected that 3 mg/L of annual effluent TN should be achievable.

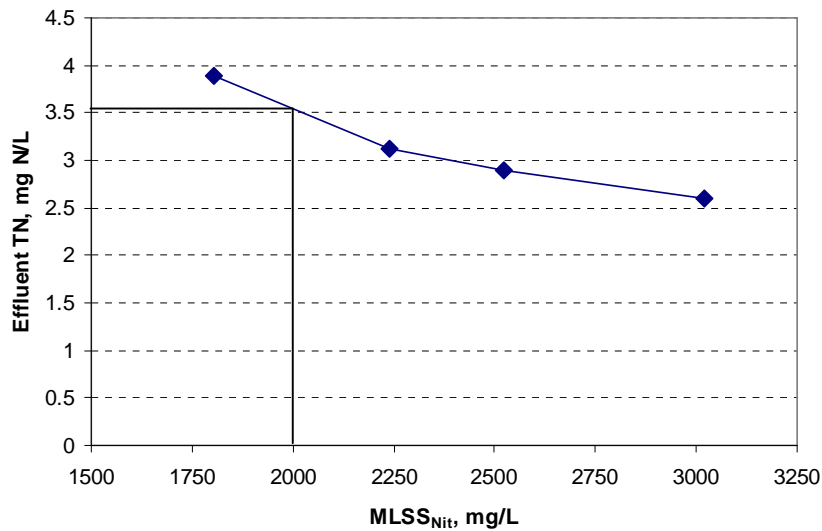

Figure 7
Scenario 3 Sensitivity Analysis Plot.
(50% seeding efficiency)

Figure 8 presents the plots of the sensitivity analyses for all three scenarios. It illustrates the incremental improvement of plant performance in terms of reducing the discharge levels of TN to Outfall 002.

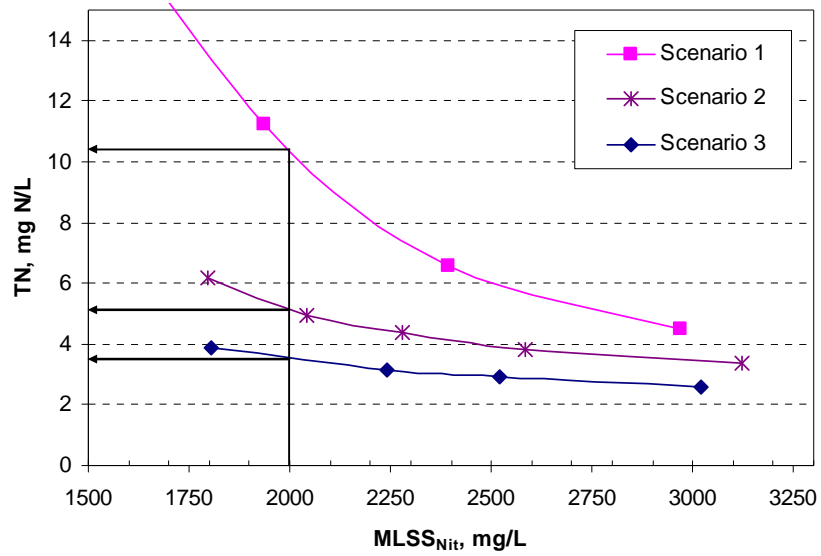

Figure 8.
All Scenario Sensitivity Analyses Plots
 (50% seeding efficiency).

TN DISCHARGE LEVELS AT AVERAGE FLOW

Metcalf & Eddy has evaluated the expected plant annual performance regarding TN discharge loadings for three scenarios at an average annual design flow of 370 MGD. The objective was to verify the plant capability to achieve the annual effluent TN levels of 5 and 3 mg/L via Outfall 002, and to assess its capability before and after placing the anaerobic digesters online. This section also describes operating conditions to enhance nitrogen removal. Specifically, bioaugmentation is currently provided by returning waste activated sludge from the nitrification/denitrification process to the west secondary process.

Modeling Approach and Design Criteria

The baseline model of BPAWTP was used to run steady state simulations under an average influent flow of 370 MGD with the related loads. Each simulation represented a month of the year where the temperature in the model was adjusted to reflect the minimum average temperature for that month.

The design criteria used to evaluate the baseline model in the previous section were used here as well except for the following:

- 1- The primary solids removal efficiency was adjusted to 60% rather than 55% to reflect performance data from stress testing. At average flow, the TSS removal is 60% and at maximum month flows the solids removal in primary is 55%.
- 2- The west secondary reactors were operated in a step feed mode to reflect the actual plant operation with the augmentation of the nitrification/denitrification WAS into the west secondary process.
- 3- The baseline model flows and loads were adjusted to the average annual flow of 370 MGD. The following table presents these flows and loads.

Flow, MGD =	370
TSS, mg/L =	136
BOD, mg/L =	122
TKN, mg N/L =	25
TP, mg/L =	3

Monthly Temperatures

The plant average daily wastewater temperatures from Outfall 002 during the period of 2002 through 2004 were evaluated to estimate the design temperatures for each steady state run. The

average monthly temperatures were calculated for each month in that period (Figure 9). The minimum temperature of the average monthly temperatures for each month during the study period was selected as the modeling temperature for each specific run. Figure 10 shows the temperatures that were used to run each simulation, i.e. each month.

**Monthly Average Wastewater Temperatures
(2002 - 2004)**

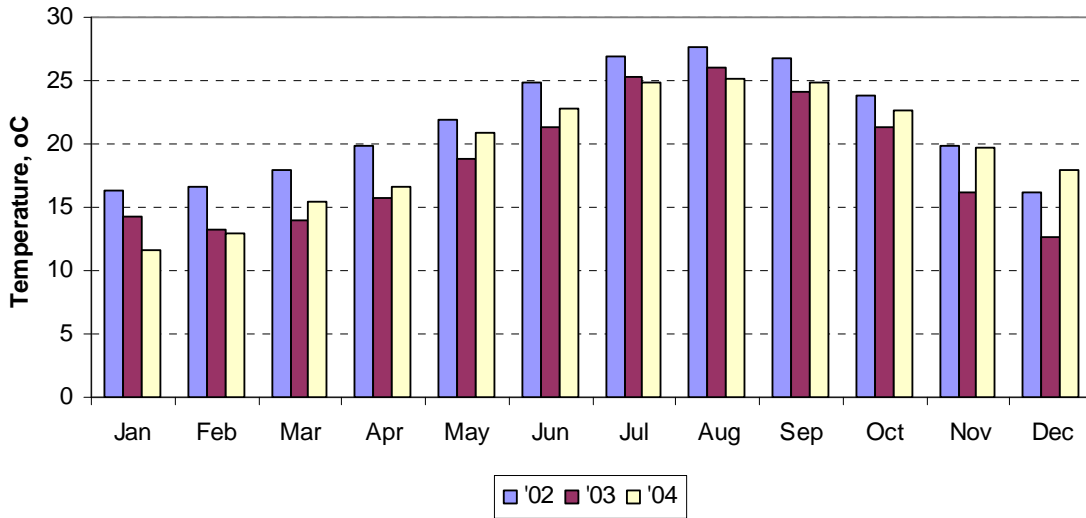

**Figure 9.
Average Monthly Wastewater Temperatures at Blue Plains**

Minimum average monthly temperatures
(2002 - 2004)

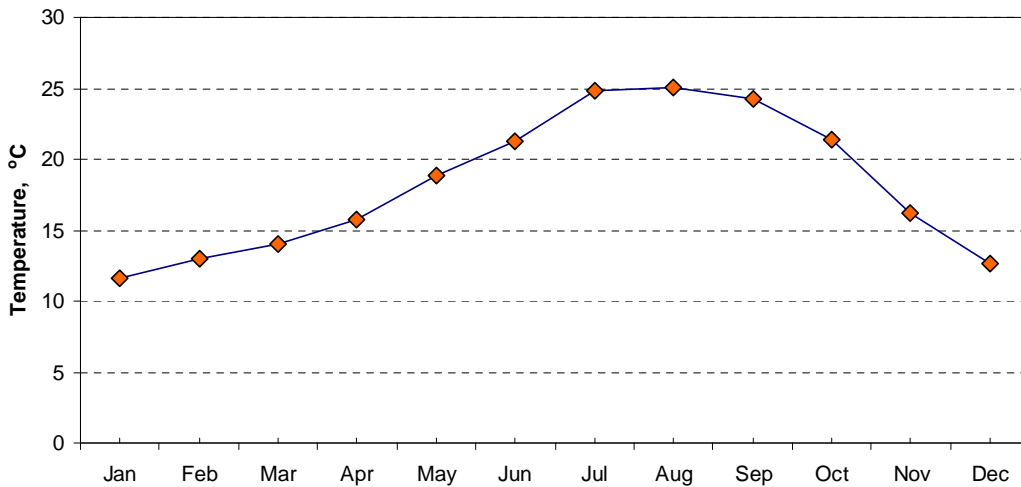

**Figure 10
Minimum Average Monthly Wastewater Temperatures**

Design Scenarios

Based on the findings from the previous section, the annual TN scenarios were categorized under two main scenarios: Scenario 2 (CTF + Existing BNR Reactors), and Scenario 3 (CTF + 4 additional BNR Reactors) to achieve annual effluent TN levels of 5 and 3 mg/L respectively. Scenario 1 is the baseline condition and, as described earlier, can not reliability achieve a TN less than 7.5 mg/L under the design condition.

The plant was able to achieve nitrogen removal in the west secondary reactors by bioaugmenting a community of nitrifiers and denitrifiers from the waste activated sludge of the nitrification/denitrification process (WAS_{nit}) into the west secondary process. In this memo, this exercise is referred to as “Secondary Bioaugmentation” or for short “Sec. Bioaug.” This type of seeding has proved to be effective in enhancing the plant nitrogen removal performance, and thus it was considered in the development of the annual TN scenarios.

The following scenarios were considered for annual effluent TN evaluation:

Scenario 2: CTF + Existing BNR Reactors

- 2.a CTF + Existing BNR Reactors + “Sec. Bioaug.”
- 2.b CTF + Existing BNR Reactors + No “Sec. Bioaug.”

Scenario 3: CTF + 4 additional BNR Reactors

- 3.a CTF + 4 additional BNR Reactors + “Sec. Bioaug.”
- 3.b CTF + 4 additional BNR Reactors + No “Sec. Bioaug.”

Initial steady state simulations were performed on all four scenarios at the design temperature of 12 °C and the plant influent flow of 370 MGD. Table 6 presents the results of these steady state simulations in terms of effluent TN, ammonia, and nitrate. The secondary bioaugmentation effect on the plant’s overall TN removal performance is clearly pronounced as seen from the results.

Table 6. TN Discharge Results including Ammonia and Nitrate.		
Existing BNR Reactors	With CTF (assumes 50% seeding efficiency)	
“Sec. Bioaug.”	2.a	TN, mg/L = 3.77 Ammonia, mg N/L = 0.45 Nitrate, mg N/L = 1.59
No “Sec. Bioaug.”	2.b	TN, mg/L = 5.01 Ammonia, mg N/L = 1.27 Nitrate, mg N/L = 2.02
4 additional BNR Reactors	With CTF (assumes 50% seeding efficiency)	
“Sec. Bioaug.”	3.a	TN, mg/L = 2.88 Ammonia, mg N/L = 0.13 Nitrate, mg N/L = 1.08
No “Sec. Bioaug.”	3.b	TN, mg/L = 3.41 Ammonia, mg N/L = 0.26 Nitrate, mg N/L = 1.48

Monthly effluent TN profiles were generated for the previous scenarios, assuming average influent flow of 370 MGD and the temperature for each month as shown in Figure 10. Charts illustrating monthly effluent TN concentrations in terms of ammonia, nitrate, and organic nitrogen (organic N) are presented for each scenario in Table 6. In addition, average methanol dosing rates (gallons per day) for each month was plotted (Figures 11, 12, 13, and 14).

- Note the organic N is about 1.5 to 1.7 mg N/L in all simulations.
- Bioaugmentation provides a positive effect on TN removal during cold months, and on methanol consumption in the warmer months.

**Monthly Outfall 002 TN Discharges
(Exst. Tnk._CTF_Sec. Bioaug.)**

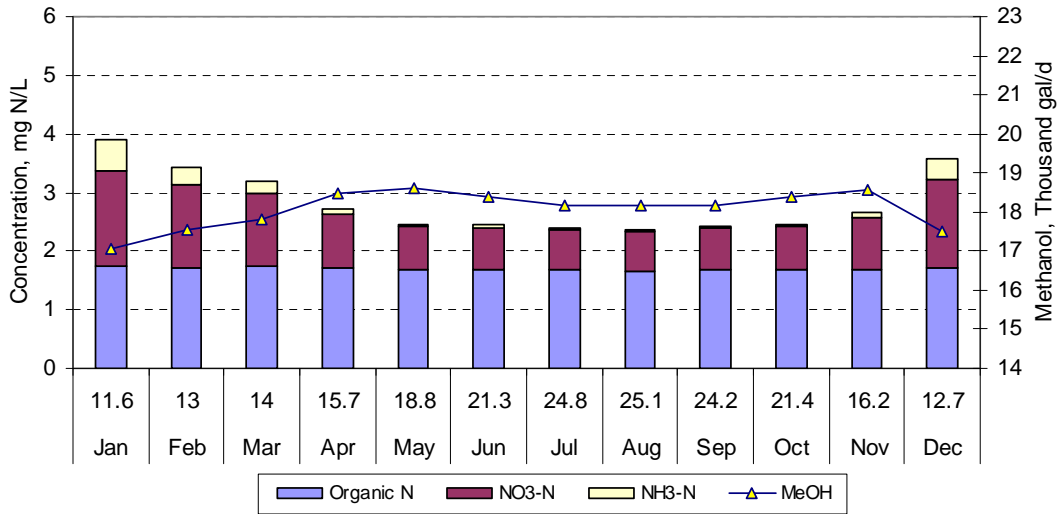

**Figure 11.
Scenario 2.a Simulated Monthly Effluent TN**

**Monthly Outfall 002 TN Discharges
(Exst. Tnk._CTF_No Sec. Bioaug.)**

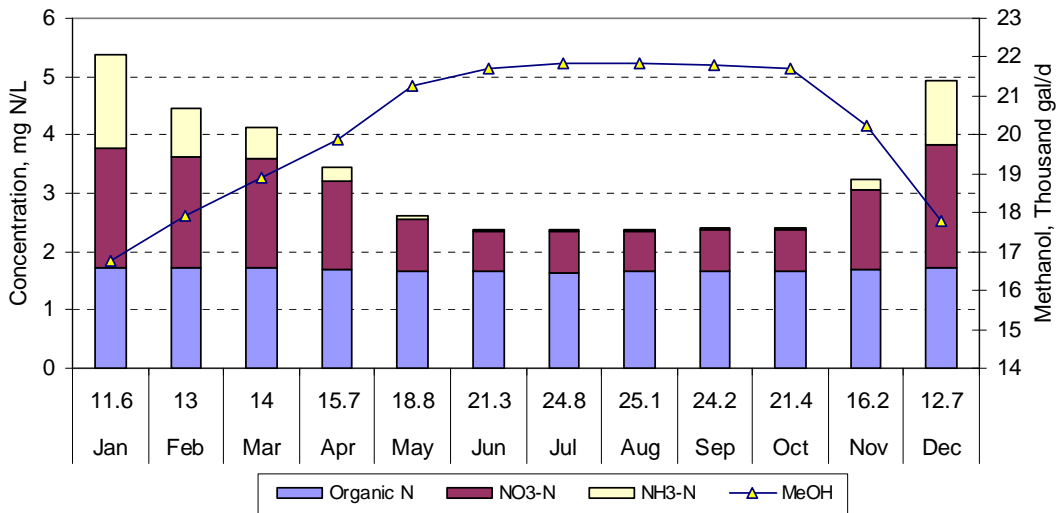

**Figure 12.
Scenario 2.b Simulated Monthly Effluent TN**

**Monthly 002 Nitrogen Discharges
(4 add Tnks_CTF_Sec. Bioaug.)**

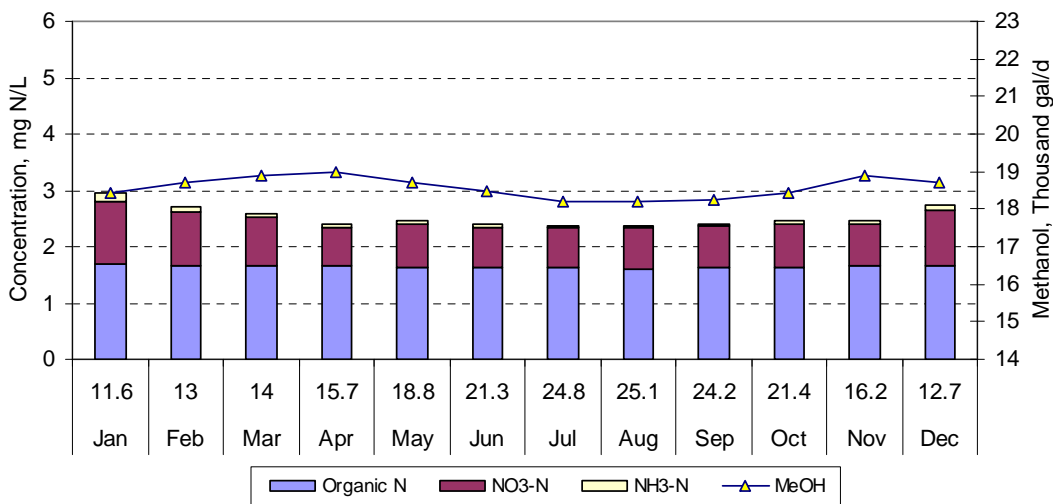

**Figure 13.
Scenario 3.a Simulated Monthly Effluent TN**

**Monthly 002 Nitrogen Discharges
(4 add Tnks_CTF_No Sec. bioaug.)**

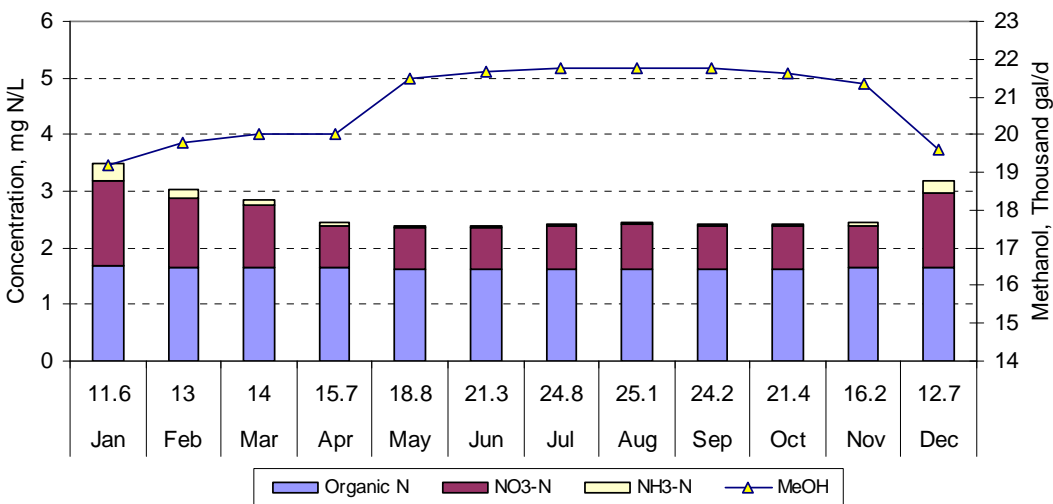

**Figure 14.
Scenario 3.b Simulated Monthly Effluent TN**

The previously described scenarios assume that anaerobic digesters augmented with a separate centrate side stream treatment facility are online. Since these projects are yet to be built, evaluation of plant performance without anaerobic digestion facilities, hence no CTF, is important

to review in case the new regulations regarding Outfall 002 TN discharge limits are issued prior to commissioning of these facilities. Therefore, the following two scenarios were evaluated:

- Existing BNR Reactors + No digestion nor CTF + Secondary Bioaugmentation
- 4 additional BNR reactors + No digestion nor CTF + Secondary Bioaugmentation

Figures 15 and 16 show the monthly TN discharges via Outfall 002 for these scenarios. The TN values include ammonia, nitrate, and organic nitrogen. The figures also show the average monthly methanol dosing requirement for each scenario.

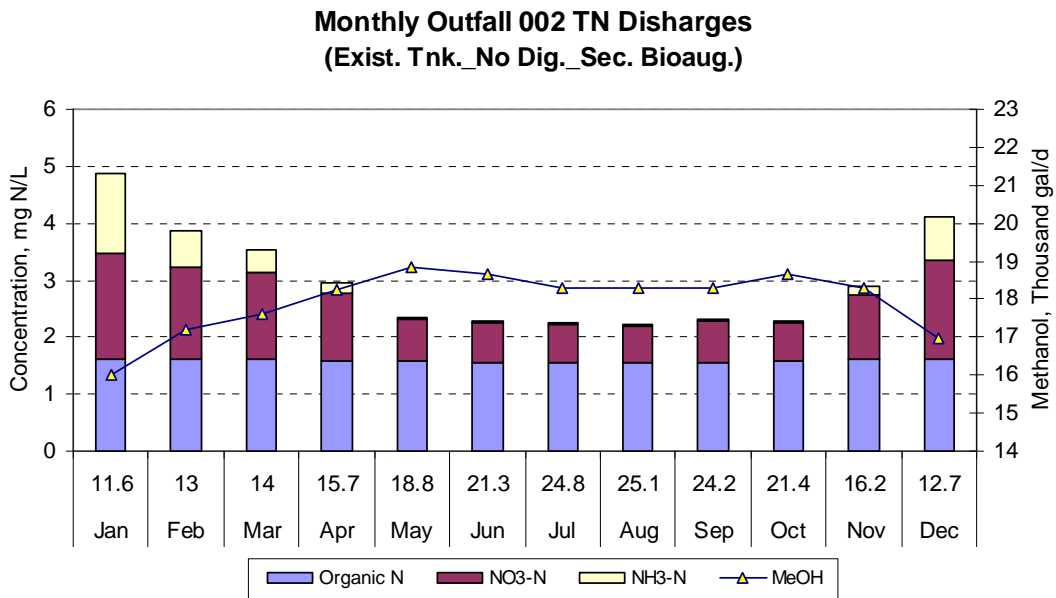

**Figure 15.
Simulated Monthly Effluent TN without Digestion Facility
(includes secondary bioaugmentation)**

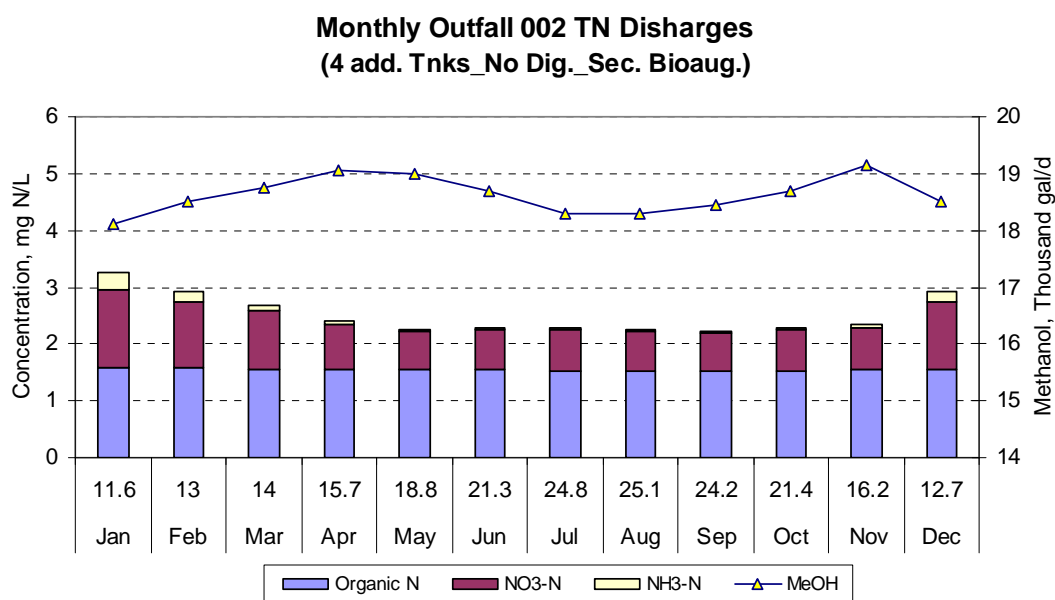

Figure 16.
Simulated Monthly Effluent TN with Additional Reactors
but no Digestion Facility
 (includes secondary bioaugmentation)

The effect of the anoxic methanol utilizers kinetics on TN removal

All simulations in this memo were based on the calibration model. The calibration model utilizes specific growth rate of the anoxic methanol utilizers (anoxic μ_{MAX}) of 2.7 d^{-1} with a temperature dependency coefficient (θ) of 1.03. This anoxic μ_{MAX} value is more conservative than the BioWin's default value of 6.4 d^{-1} , however, it was not determined based an actual measurement, but was estimated based on the calibration effort. The calibration period was the full year of 2002, which had a dry spring and mild winter. Under these mild conditions, it was difficult to determine the sensitivity of the microorganisms to changes in flows and temperature. In addition to that, the model presumed denitrification occurred in the anoxic zones only, but in reality and under the calibration period operations, denitrification may have occurred in zones where DO levels are low such as sludge blankets, mixed liquor effluent channel, and poorly mixed zones. With that said, it was recommended that further testing would help verifying the actual value of the anoxic growth rate. Recent high F/M batch tests that were performed at the plant laboratory to determine the value of the anoxic μ_{MAX} indicate values lower than 2.7 d^{-1} . However, sufficient testing has not been completed to change the calibration model assumptions. Hence, further work is required.

CONSIDERATIONS AND RECOMMENDATIONS

Engineers generally use a “factor of safety” in their designs. For example, if an engineer were to apply a factor of safety of 2 to the size of a facility, that means that once a size is determined based on a set of calculations, the size would be doubled. Factors of safety are essential to compensate for unknowns. However, wastewater process modeling is too complex to accommodate a simple factor into the results. For that reason, conservative assumptions are made during the development and application of the model to account for unknowns. Therefore, results of the modeling should be evaluated in the context of the following assumptions that were inherent in the model:

- The selection of maximum month flow and the related loads at 12 °C as the design condition.
- The mode of operation of the biological treatment processes is in a plug flow mode rather than step-feed operation mode.
- The assumption that approximately 1.3 mg N/L of soluble un-biodegradable organic nitrogen is present in the plant final effluent.

However, the following unidentified parameters should be considered for further evaluation as they may significantly affect the plant performance, and hence affect the design approach. The following parameters are of primary interest:

- The degree and efficiency of seeding from the CTF to the main process
- The kinetic parameters for the anoxic methanol utilizing organisms under cold temperatures: Including the growth and decay rates, and temperature dependency.
- The efficiency of seeding from Secondary Bioaugmentation.: In all runs with Secondary Bioaugmentation., the seeding efficiency was considered to be 100%. There are no measured value at this time, hence the results from bioaugmentation runs present the optimum plant overall performance improvements due to bioaugmentation.

These parameters and unknowns can be determined by means of pilot and bench scale testing. Furthermore, process modeling can then be used to determine the effect of these parameters on design requirements.

**District of Columbia Water and Sewer Authority
Blue Plains Total Nitrogen Removal /
Wet Weather Plan**

APPENDIX C

Process Model Calibration Report

PROCESS MODEL CALIBRATION REPORT

DCWASA BLUE PLAINS

USING DATA COLLECTED IN 2002

Feb-05

PREPARED BY :

PREPARED FOR :

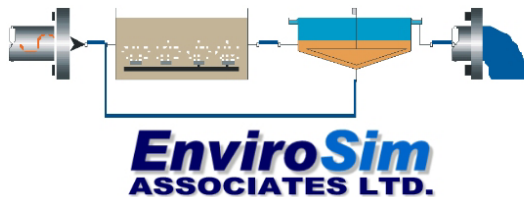

EnviroSim Associates Ltd.
7 Innovation Drive ~ Suite 205 Flamborough, Ontario L9H 7H9 CANADA
Tel 905-690-1122 fax 905-689-2200
info@envirosim.com

Notice

This report was prepared by EnviroSim Associates Ltd. under contract to METCALF & EDDY. The material in the report reflects the best judgment of EnviroSim Associates Ltd. in light of the information available to it at the time of preparation. Any use which a third party makes of this report, or any reliance on or decisions to be made based on it are the responsibility of such third parties. EnviroSim Associates Ltd. accepts no responsibility for damages, if any, suffered by any third party as a result of decisions made or actions based on this report.

TABLE OF CONTENTS

CHAPTER 1 : EXECUTIVE SUMMARY	1
1.1 RECOMMENDATIONS	3
CHAPTER 2 : MODELING OF THE DCWASA PLANT (BLUE PLAINS).....	5
2.1 OBJECTIVE	5
2.2 MODEL CONSTRUCTION.....	5
2.3 PLANT CONFIGURATION.....	6
2.4 MODELS USED.....	8
2.5 PHYSICAL DIMENSIONS.....	9
2.6 OPERATIONAL DATA.....	10
2.6.1 DO SETPOINTS.....	10
2.6.2 SLUDGE RETURN FLOWS.....	12
2.6.3 WASTE FLOWS.....	13
2.6.4 INFLUENT FRACTIONATION.....	13
2.6.5 OTHER OPERATIONAL PARAMETERS.....	14
2.7 MODEL CALIBRATION.....	15
2.8 STEADY-STATE RUN	16
2.8.1 PRIMARY EFFLUENT.....	16
2.8.2 SECONDARY EFFLUENT	17
2.8.3 NITRIFICATION EFFLUENT.....	18
2.8.4 MIXED LIQUOR	18
2.9 RESULTS OF THE DYNAMIC SIMULATION.....	19
CHAPTER 3: MODELING GUIDANCE	31
3.1 HINTS TO ACCELERATE MODEL PERFORMANCE.....	32
3.1.1 STEADY-STATE RUNS	32
3.1.2 DYNAMIC RUNS.....	33
APPENDIX.....	34

LIST OF FIGURES

FIGURE 1.	DCWASA PLANT CONFIGURATION IN BIOWIN	7
FIGURE 2.	EAST PRIMARY INFLUENT FLOW.....	19
FIGURE 3.	WEST PRIMARY INFLUENT FLOW.....	19
FIGURE 4.	TEMPERATURE (NITRIFICATION FE).....	20
FIGURE 5.	EAST WAS FLOW.....	20
FIGURE 6.	WEST EVEN (RX 2) WAS FLOW	20
FIGURE 7.	WEST ODD (RX 1) WAS FLOW	20
FIGURE 8.	NITRIFICATION ODD WAS FLOW	21
FIGURE 9.	NITRIFICATION EVEN WAS FLOW	21
FIGURE 10.	EAST INFLUENT TSS AND VSS	21
FIGURE 11.	WEST INFLUENT TSS AND VSS.....	21
FIGURE 12.	EAST PRIMARY EFFLUENT TSS.....	22
FIGURE 13.	WEST PRIMARY EFFLUENT TSS.....	22
FIGURE 14.	EAST PRIMARY EFFLUENT TP AND SP.....	22
FIGURE 15.	WEST PRIMARY EFFLUENT TP AND SP.....	22
FIGURE 16.	MLSS IN WEST SECONDARY ODD REACTORS.....	23
FIGURE 17.	MLSS IN WEST SECONDARY EVEN REACTORS.....	23
FIGURE 18.	MLSS IN EAST REACTORS 3, 4	23
FIGURE 19.	MLSS IN EAST REACTORS 5, 6	23
FIGURE 20.	EAST WAS.....	24
FIGURE 21.	WEST EVEN (RX 2) WAS	24
FIGURE 22.	WEST ODD (RX 1) WAS.....	24
FIGURE 23.	WEST SECONDARY EFFLUENT TSS.....	24
FIGURE 24.	WEST SECONDARY EFFLUENT BOD	25
FIGURE 25.	EAST SECONDARY EFFLUENT TSS.....	25
FIGURE 26.	EAST SECONDARY EFFLUENT BOD	25
FIGURE 27.	EAST SECONDARY EFFLUENT AMMONIA	25
FIGURE 28.	WEST SECONDARY EFFLUENT AMMONIA.....	25
FIGURE 29.	EAST SECONDARY EFFLUENT TP.....	26
FIGURE 30.	WEST SECONDARY EFFLUENT TP.....	26
FIGURE 31.	EAST SECONDARY EFFLUENT SP	26
FIGURE 32.	WEST SECONDARY EFFLUENT SP.....	27
FIGURE 33.	MLSS IN NITRIFICATION ODD	27
FIGURE 34.	MLSS IN NITRIFICATION EVEN	27
FIGURE 35.	NITRIFICATION ODD WAS.....	27
FIGURE 36.	NITRIFICATION EVEN WAS	28
FIGURE 37.	NITRIFICATION ODD AMMONIA AND NITRATE.....	28
FIGURE 38.	NITRIFICATION EVEN AMMONIA AND NITRATE.....	28
FIGURE 39.	NITRIFICATION ODD TP AND TSP	28
FIGURE 40.	NITRIFICATION EVEN TP AND TSP	29
FIGURE 41.	NITRIFICATION ODD EFFLUENT TSS	29
FIGURE 42.	NITRIFICATION EVEN EFFLUENT TSS.....	29
FIGURE 43.	SECONDARY SRT.....	29
FIGURE 44.	NITRIFICATION SRT	30

LIST OF TABLES

TABLE 1. PHYSICAL DIMENSIONS OF REACTORS AND SETTLERS.....	9
TABLE 2. DO SETPOINTS AT DCWASA	11
TABLE 3. EAST SECONDARY MASS BALANCE	12
TABLE 4. DCWASA RETURN FLOWS	13
TABLE 5. EAST AND WEST INFLUENT FRACTIONS 2002	14
TABLE 6. DAILY FERRIC AND PICKLE LIQUOR DOSING 2002	15
TABLE 7. PRIMARY EFFLUENT CONCENTRATIONS.....	16
TABLE 8. SECONDARY EFFLUENT CONCENTRATIONS.....	17
TABLE 9. NITRIFICATION EFFLUENT CONCENTRATIONS	18
TABLE 10. AVERAGE SOLIDS CONCENTRATIONS AT THE PLANT	19

CHAPTER 1 : EXECUTIVE SUMMARY

EnviroSim Associates, Inc. conducted data reconciliation and model calibration on daily average plant flow and quality data provided by DCWASA for the year of 2002. The **objective** of the project was to prepare a comprehensive model for the DCWASA plant in BioWin, that can be used by the plant personnel and consultants for analysis of plant operation, future scenarios, and plant data quality assurance (reconciliation).

The **configuration** implemented in BioWin™ Version 2.1 included all important processes on the plant: East and West Primary Influent and Primaries, the Secondary stage in four separate trains, ferric and pickle liquor dosing at five locations, Nitrification stage Even and Odd reactors, with methanol and lime dosing, and the full sludge treatment line.

The 2002 data set provided by the plant was filtered for outliers and imported into BioWin as forcing functions (flows, influent concentrations) and for plotting data against model results. East and West influent CODs and COD fractions were estimated from available BOD, TSS and VSS measurements using the **Influent Specifier**, complemented by typical municipal wastewater fractions where necessary. The results of an additional 2 week influent fractionation campaign were also considered to a certain extent in establishing best estimates for influent fractions. A preliminary steady-state calibration was performed, followed by a series of dynamic simulations for the whole period from January 1st until December 31st, 2002.

Important **conclusions** that can be drawn from the modeling runs are as follows:

- The **dataset** in general was of good quality and provided consistent results throughout the year.
- A relatively low fraction of the data was **outliers** – potentially a result of sampling, data entry or analysis errors. These datapoints were removed using visual checks on trendlines, simple statistics (outside two times standard deviation), and did not effect the overall quality of the modeling.
- Several **assumptions** were made in the model, regarding e.g. a) flowsplits that are not measured, b) the degree of model detail (e.g. number of trains) that can be used while not degrading execution speed and c) simplified plant operation (DO setpoints, etc.). The model gave a very close match with the important process indicators.
- **Clarifier mass balances** were performed on the yearly average data. The solids mass input (clarifier inflow x MLSS) was compared to the sum of the effluent and RAS solids mass flow. These gave good results for both trains of the nitrification stage and the Secondary West Odd clarifiers. The Secondary East clarifiers output 29% more solid mass than the input, and Secondary West Even clarifiers output 37% less solids. This points to a potential problem in sampling those return lines, and was taken into account in the model.

- Measured *waste flow* in the East Secondaries was adjusted in the model to match MLSS concentrations in these trains. MLSS values in the West Secondary train and the Nitrification matched well with measured data when using reported waste flows. The difference on the East side might be a result of the approximate influent load estimation (based on TSS and BOD, instead of COD), and maybe non-ideal flow distributions in the plant. This correction was done to maintain the necessary process conditions for the calibration, and is not an indication that there is a problem with waste flow measurement (though waste flow seems to be a difficult to measure parameter in plants in our experience). There are many factors that influence MLSS levels, and without more detailed influent fractionation and flow distribution information within the plant we did not attempt to hypothesize about possible causes.
- Regularly collected operational data on the plant are not meant to and do not contain enough information for detailed calibration of kinetics, stoichiometry and settling. However with a few specific exceptions listed below, there is no indication from this analysis that model parameter values would deviate significantly from other similar municipal plants in the same geographic area (Eastern United States). BioWin 2.1 *default parameter values* were used in all but 6 instances.
 1. The **nitrification** growth rate was reduced from the default 0.9 d^{-1} to 0.8 d^{-1} , and the autotrophic DO switch was increased from 0.25 to 0.5 mgDO/L. There is not enough information in the effluent ammonia concentration from the Nitrification stage (which is always fully nitrified) to be able to evaluate the value of this parameter more accurately. The estimation is based on the minimum nitrification growth rate that the model must use in order to predict full nitrification occurring during the winter in accordance with observations. This value will also predict nitrification occurring in the Secondary stage, under operating conditions in 2002, and under the new, seeded configuration in 2004. It has to be recognized that nitrification can be limited due to DO availability in the Secondaries. This is taken into account in an approximate way but detailed aeration modeling would be necessary to provide a better estimate of the DO effect. The uncertainty in the DO levels can be handled in the model using a higher DO saturation switch (0.5 mgDO/L was selected).
 2. The **Anoxic Methanol Utilizer** Maximum Specific Growth rate was reduced from the default 6.4 to 2.7. This value causes about 6-7% of methanol to bleed (i.e. increasing the methanol dose would not lead to significantly higher denitrification rates), and the effluent nitrate concentrations are well matched both for 2002 and for the new seeded configuration.
 3. In addition to the methanol dose and kinetics, denitrification and effluent nitrate concentrations depend on ammonia nitrified in the Secondaries. There is partial nitrification/denitrification occurring in the West side in the model. The nitrified ammonia is denitrified in the plant Secondary stages, probably in non-ideally mixed tanks, channels, and sludge blankets. This is taken into account in the model by increasing the **simultaneous aerobic denitrification switch** on the West side only (implemented as a local kinetic parameter). The 0.45 mgO₂/L value selected will produce secondary effluent nitrate concentrations very close to the measured low concentrations at the plant for two operating conditions: 1) 2002, when no nitrifying sludge was recycled back to the Secondaries 2) 2004, with nitrifying sludge wasted back to the West side of the Secondaries.
 4. In *chemical phosphorus removal* a molar ratio of 3.5 [molFe / molP removed] was used instead of the default 1.6. This value results in a close match of orthophosphate concentrations all through the plant. The chemical phosphorus removal module is new in BioWin, and there is not enough experience from different plants at the moment to

indicate if the difference is unique to DCWASA, or maybe the default value should be revised.

5. The *equilibrium* PO_4^{3-} concentration at pH 7 is set to 15 $\mu\text{gP/L}$, to match the lowest measured values at the plant ($\sim 10 \mu\text{gP/L}$ at pH 6.7). In reality soluble P concentrations are likely to be even lower at the plant, but the detection limit currently is 10 $\mu\text{gP/L}$.
 6. *P content* of biomass was set to 1.5% from the default 2.2%. It is typical in plants under intermittent nutrient limitation that biomass P or N contents are lower than default values. If the default value is used, the nitrification stage runs out of P and becomes nutrient limited many times during the year, in spite of the redissolution of iron phosphate precipitate originating from the secondaries.
- *Ideal settler and clarifier models* were used in the configuration, to improve numerical performance. On a 1.1 GHz Pentium a steady-state simulation takes about 4 minutes and a one year dynamic run about 30 hours. The ideal settler models do not track some of the elevated effluent solids episodes that occurred in the plant. If this is important for any further modeling studies, more detailed settling modeling using a flux based model, and measurement of Vesilind settling parameters will be necessary.

1.1 RECOMMENDATIONS

The main objective of this study was to develop a detailed calibrated model for the Blue Plains plant. This model can now be used for modeling operational and expansion scenarios at DCWASA for the following processes:

- BOD removal in the Secondary stage
- Ferric and Ferrous addition and P removal,
- Nitrification and denitrification using methanol
- Sludge treatment
- Future processes that are incorporated in BioWin (design mode)

The full configuration as implemented in BioWin can also be used as a starting point for simplified configurations for specific studies.

There are three BioWin configurations and three Excel spreadsheets supplied with this report:

1. DCWASA 2002 calibration (.bwc and .xls files). This contains the 2002 full dataset (daily and yearly average data after data filtering), and the calibrated model.
2. DCWASA full (.bwc and .xls files). This contains the full configuration for the plant. Dynamic data has been stripped from the files to reduce size. This is a convenient configuration to start detailed steady-state or dynamic modeling studies on the plant.
3. DCWASA simple (.bwc and .xls files). This configuration is simplified to one Secondary and one Nitrification train. Dynamic data has been stripped from the files to reduce size. It can be used for quick scenario analysis or as a source for future simulations that do not require the full detail of the large layout. It is significantly faster than the full configuration.

All three configurations contain an Album page that (after a steady-state run) can be directly copied to the relevant Excel spreadsheet for easy access to the most important process indicators. For details please see guidance in the Excel spreadsheets.

Further investigations might improve model performance and data quality at the plant in the following areas:

- Experimental Influent Fractionation
- Experimental measurement of nitrification rates
- Experimental measurement of anoxic methanol utilization rates
- Experimental measurement of COD/VSS/TSS/N/P ratios in various locations in the activated sludge
- Data reconciliation around settlers/clarifiers
- Experimental measurement of settling parameters if more detailed settling/clarification modeling is required
- Verification of sludge production, waste flows, inert solids mass balances through the plant

CHAPTER 2 : MODELING OF THE DCWASA PLANT (BLUE PLAINS)

2.1 OBJECTIVE

The objective of this project was to prepare a comprehensive model for the DCWASA plant implemented in BioWin, that can be used by the plant personnel and consultants for analysis of plant operation, future scenarios, and plant data reconciliation.

2.2 MODEL CONSTRUCTION

The DCWASA Advanced Wastewater Treatment Plant consists of primary settling, short SRT BOD removal stage (Secondary Stage), nitrification-denitrification stage and filters. The sludge line includes gravity thickening, DAFs, sludge blending, and dewatering by two sets of centrifuges. The aim in constructing the plant configuration in BioWin was to provide one global model that can be used for overall plant analysis and mass balancing. The model can also be used as a starting point for investigating more specific scenarios.

Physical and operational data (daily averages of influent, WAS, RAS, primary sludge, GT, DAF flows, chemical doses, pH, temperature) provided by DCWASA for the year of 2002 was entered into BioWin. The daily composite lab records were analyzed, and filtered for obvious outliers (sampling or analysis problems), discarding most quality data that was outside the limits set by 2 times standard deviation around the yearly average.

The Influent Specifier spreadsheet tool was used for East and West primary influents to create the required COD concentrations and fractions.

All flow itineraries were copied into BioWin (influent, WAS, RAS, primary sludge, GT, DAF flows). pH, ferric dose, temperature were added.

All data was imported with initial time added, i.e. time (days) is increasing from 0 to 364 during the year of 2002.

Graphs and tables were defined in the Album. An overall data table (Summary table) was also created. The contents of this table can be copied into the "DCWASA 2002 calibration.xls" spreadsheet, BioWin Table Tab, for easy comparison with measured yearly averages on the plant.

2.3 PLANT CONFIGURATION

The following process units were represented in the overall BioWin model:

- East and West Primary Influent (COD influent)
- East and West Primary Settlers (ideal settler model)
- Secondary Biological Stage, implemented as separate activated sludge trains (four tanks in series each) for Reactors 1, 2 on the West side and 3&4 and 5&6 on the East.
- Secondary clarifiers (ideal clarifier model)
- Ferric dosing at five points to the primaries and the secondary process
- Nitrification (five tanks in series), Odd and Even sides
- Methanol dosing on both Nitrification sides separately to pass #4
- Lime/caustic addition to Nitrification
- Sand filter (represented by ideal clarifiers)
- Combined plant effluent
- Gravity thickening of primary sludge (ideal clarifier)
- DAF unit for Secondary and Nitrification sludge (dewatering unit)
- Three blend tanks for sludge blending (equalization tanks)
- Two centrifuges for dewatering of blended sludge (dewatering units)
- Lime addition to dewatered sludge
- Combined plant dewatered sludge

The configuration is shown in Figure 1.

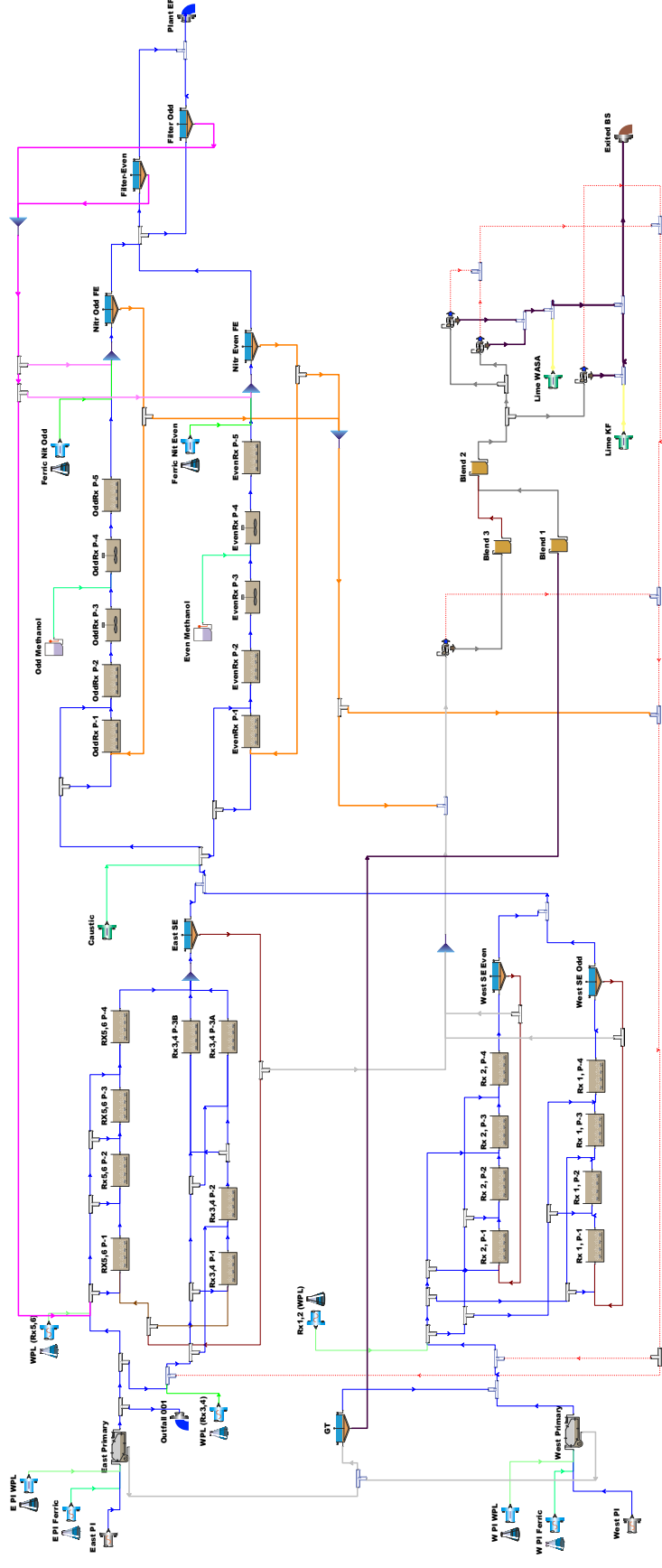

FIGURE 1. DCWASA PLANT CONFIGURATION IN BioWin

2.4 MODELS USED

BioWin Version 2.1 provides several options for model selection, to best describe the relevant processes on the plant and simplify those that are not important. This helps to reduce model complexity. The following model options were selected for this project:

- BioWin Activated Sludge - Digester Model (ASDM).
- pH calculation and effect of pH on the biological process (pH limitation)
- Chemical (ferric) dose. Biowin assumes that the pickle liquor (Fe^{2+} salts) will be oxidized to ferric (Fe^{3+}) relatively quickly in the aerated secondary stage.
- Phase separation in settlers, thickeners, DAFs, and centrifuges is based on ideal separation (percent removal model).

2.5 PHYSICAL DIMENSIONS

Table 1 contains the list of reactors and settlers with their physical dimensions in the model.

TABLE 1. PHYSICAL DIMENSIONS OF REACTORS AND SETTLERS

Train	Element Type	Name	Volume	Area	Depth
			MG	ft²	ft
	Primary	East Primary		226080	16.8
East Secondary	Bioreactor	RX5,6 P-1	1.07	9520	15
	Bioreactor	RX5,6 P-2	1.07	9520	15
	Bioreactor	RX5,6 P-3	1.07	9520	15
	Bioreactor	RX5,6 P-4	1.07	9520	15
	Bioreactor	RX3,4 P-1	3.00	26680	15
	Bioreactor	RX3,4 P-2	3.00	26680	15
	Bioreactor	RX3,4 P-3	3.00	26680	15
	Bioreactor	RX3,4 P-4	3.00	26680	15
	Final settler	ES Final		236592	12
	Primary	West Primary		141120	14.4
West Secondary	Bioreactor	Rx 2, P-1	1.50	13340	15
	Bioreactor	Rx 2, P-2	1.50	13340	15
	Bioreactor	Rx 2, P-3	1.50	13340	15
	Bioreactor	Rx 2, P-4	1.50	13340	15
	Final settler	WS Even Final		118296	12
	Bioreactor	Rx 1, P-1	1.50	13340	15
	Bioreactor	Rx 1, P-2	1.50	13340	15
	Bioreactor	Rx 1, P-3	1.50	13340	15
	Bioreactor	Rx 1, P-4	1.50	13340	15
	Final settler	WS Odd Final		118296	12
Total Secondary			28.27		
Nitrification Odd	Bioreactor	OddRx P-1	5.37	23904	30
	Bioreactor	OddRx P-2	5.37	23904	30

	Bioreactor	OddRx P-3	5.37	23904	30
	Bioreactor	OddRx P-4	5.37	23904	30
	Bioreactor	OddRx P-5	5.37	23904	30
	Final settler	Odd Nitr Sed		267652	15.5
Nitrification Even	Bioreactor	EvenRx P-1	5.37	23904	30
	Bioreactor	EvenRx P-2	5.37	23904	30
	Bioreactor	EvenRx P-3	5.37	23904	30
	Bioreactor	EvenRx P-4	5.37	23904	30
	Bioreactor	EvenRx P-5	5.37	23904	30
	Final settler	Even Nitr Sed		267652	15.5
Filters	Filter Even			41600	6
	Filter Odd			41600	6
Sludge handling	Ideal Settler	GT		16583	11.8
	Dewatering unit	DAF			
	Equalization tank	Blend 1	0.32		
	Equalization tank	Blend 2	0.32		
	Equalization tank	Blend 3	0.32		

2.6 OPERATIONAL DATA

2.6.1 DO SETPOINTS

DO setpoints in the individual reactors were set as constant values for all of 2002, according to averaged DO measurements, and are shown in Table 2

TABLE 2. DO SETPOINTS AT DCWASA

Train	Reactor Name	DO setpoint
East Secondary	RX5,6 P-1	0.5
	RX5,6 P-2	0.5
	RX5,6 P-3	1.0
	RX5,6 P-4	1.0
	RX3,4 P-1	0.5
	RX3,4 P-2	0.5
	RX3,4 P-3	1.0
	RX3,4 P-4	1.0
West Secondary	Rx 2, P-1	0.5
	Rx 2, P-2	0.5
	Rx 2, P-3	0.5
	Rx 2, P-4	1.0
	Rx 1, P-1	0.5
	Rx 1, P-2	0.5
	Rx 1, P-3	0.5
	Rx 1, P-4	1.0
Nitrification Odd	OddRx P-1	3.0
	OddRx P-2	3.0
	OddRx P-3	Anoxic
	OddRx P-4	Anoxic
	OddRx P-5	3.0
Nitrification Even	EvenRx P-1	3.0
	EvenRx P-2	3.0
	EvenRx P-3	Anoxic
	EvenRx P-4	Anoxic
	EvenRx P-5	3.0

In the Secondary Plant maximum blower capacities (4 blowers at 40,000 scfm each) were also implemented (using DO modeling) to better simulate intermittent low DO conditions. The air flow limits were

distributed according to reactor volumes – actual floor coverage and header pressures were not taken into account at this stage. Air flow limitations resulting in lower than typical DOs might have an effect in preventing or reducing partial nitrification sometimes occurring in the secondary stage.

2.6.2 SLUDGE RETURN FLOWS

Daily return flow measurements were available for all of 2002. Yearly average flow, MLSS, RAS and effluent data for each process train was used to perform mass balances around the clarifiers. The mass of sludge flowing into a clarifier and the effluent and return solids mass must balance. An example for the Secondary East train is shown below.

TABLE 3. EAST SECONDARY MASS BALANCE

Location	Data		
	Q	MLSS	Mass rate
East Secondaries	MGD	g/L	lbs/d
From 5,6	138	3220	3707341
From 3,4	138		
Effluent	182	26	39498
RAS	94	6073	4757694
Mass difference	0		1089852
Balance error %	0		29.4%

The clarifier, seemingly, is receiving 3.7 million pounds of solids a day and is outputting in the return 4.7 million pounds daily. This is a 29% mass balance error, and in reality is caused by the difficulty of measuring return flows and concentrations accurately.

Since the process model is most sensitive to MLSS and RAS concentrations, and less sensitive to return flow settings, in the current project a flow correction factor was applied to the return flow of two of the clarifier recycles (West Even and East).

As shown in the **Table 4.** below, West Even and East Return flows had higher mass balance differences and were adjusted by 20% while other return flows were left at their measured values. During dynamic runs, each of the daily return flow values were adjusted by the same factor.

TABLE 4. DCWASA RETURN FLOWS

	RAS FLOW Measured	Mass balance error	RAS FLOW Used
	mgd	%	mgd
West Odd	40.4	1	40.4
West Even	27.6	29.4	33.3
East	93.9	37.5	112.7
Nitrification Even	151.2	1.3	151.2
Nitrification Odd	128.6	7.7	128.6

Note: Changing the recycle flow and matching solids in the aeration tanks and return is purely an empirical choice to provide the most acceptable model setup and it is not an indication that return flows are actually measured with error. A separate sampling and evaluation campaign could resolve the source of the mass balance discrepancy.

2.6.3 WASTE FLOWS

Measured *waste flow* in the East Secondaries were adjusted in the model to match MLSS concentrations in these trains. MLSS values in the West Secondary train and the Nitrification matched well with measured data when using reported waste flows. The difference on the East side might be a result of the approximate influent load estimation (based on TSS and BOD, instead of COD), and maybe non-ideal flow distributions in the plant. This correction was done to maintain the necessary process conditions for the calibration, and is not an indication that there is a problem with waste flow measurement (though waste flow seems to be a difficult to measure parameter in plants in our experience). There are many factors that influence MLSS levels, and without more detailed influent fractionation and flow distribution information within the plant we did not attempt to hypothesize about possible causes.

2.6.4 INFLUENT FRACTIONATION

The EnviroSim Influent Specifier toolkit was used for the East and West Primary Influent to estimate influent COD and various fractions as required by BioWin.

Complete influent specification for fractionation was not available. The following procedure was followed:

The influent COD was initially estimated using a typical COD/BOD ratio of 2.1. Following a 2 week sampling campaign in 2004, that showed lower COD/BOD ratios, the ratio was reduced to 1.9.

Fraction of unbiodegradable soluble COD (F_{us}) was estimated from effluent filtered COD and influent total COD. Alkalinity, ammonium (F_{na}) and phosphate (F_{po4}) fractions are directly measured at the plant. VSS, TSS is also measured so ISS (=TSS-VSS) can be calculated directly. Filtered COD is not measured, and was estimated such that the COD/VSS (F_{cv}) fraction was a typical 1.5 value found in municipal plants.

Unbiodegradable particulate (Fup), and biodegradable particulate (Fbs) fractions were estimated such that calculated BOD, TSS and VSS values match with the measured data. Unbiodegradable soluble TKN (Fnus) was changed to 0.023 from the default 0.0. This represents on average 0.6mgN/L soluble unbiodegradable organic nitrogen in the effluent.

The following values were accepted for the both East and West influents for the year of 2002:

TABLE 5. EAST AND WEST INFLUENT FRACTIONS 2002

Fraction Name	Default	Value used
Fbs - Readily biodegradable (including Acetate) [gCOD/g of total COD]	0.2	0.15
Fac - Acetate [gCOD/g of readily biodegradable COD]	0.15	0.0
Fxsp - Non-colloidal slowly biodegradable [gCOD/g of slowly degradable COD]	0.75	0.88
Fus - Unbiodegradable soluble [gCOD/g of total COD]	0.05	0.043
Fup - Unbiodegradable particulate [gCOD/g of total COD]	0.13	0.10
Fna - Ammonia [gNH ₃ -N/gTKN]	0.66	0.57 (0.66)
Fnox - Particulate organic nitrogen [gN/g Organic N]	0.5	0.5
Fnus - Soluble unbiodegradable TKN [gN/gTKN]	0	0.023
FupN - N:COD ratio for unbiodegradable part. COD [gN/gCOD]	0.035	0.035
Fpo4 - Phosphate [gPO ₄ -P/gTP]	0.5	0.45
FupP - P:COD ratio for influent unbiodegradable part. COD [gP/gCOD]	0.011	0.011
FZbh - Non-poly-P heterotrophs [gCOD/g of total COD]	1.00E-04	1.00E-04
FZbm - Anoxic methanol utilizers [gCOD/g of total COD]	1.00E-04	1.00E-04
FZba - Autotrophs [gCOD/g of total COD]	1.00E-04	1.00E-04
FZbp - PAOs [gCOD/g of total COD]	1.00E-04	1.00E-04
FZbpa - Propionic acetogens [gCOD/g of total COD]	1.00E-04	1.00E-04
FZbam - Acetoclastic methanogens [gCOD/g of total COD]	1.00E-04	1.00E-04
FZbhm - H ₂ -utilizing methanogens [gCOD/g of total COD]	1.00E-04	1.00E-04

Influent fractionation is one of the most important information that is required for accurate process modeling. It is recommended that further COD and filtered COD (GFC and FF COD) measurements be performed to increase the reliability of the model.

2.6.5 OTHER OPERATIONAL PARAMETERS

Daily ferric and pickle liquor dosing, as well as methanol dosing values were used as provided by the plant. The following table contains the values used for 2002:

TABLE 6. DAILY FERRIC AND PICKLE LIQUOR DOSING 2002

Dosage	Dosing location	Flow (gpd)	Mass rate (lb/d)
Ferric	East Primaries	7030	5870
Ferric	West Primaries	4044	3375
Pickle liquor	East Rx 3,4	6250	5216
Pickle liquor	East Reactors 5,6	2127	1775
Pickle liquor	West Reactors 1,2	3660	3053
Methanol	Nitrification Odd	6260	41400
Methanol	Nitrification Even	5960	39400

2.7 MODEL CALIBRATION

Two types of simulations were performed on the year 2002 dataset: steady state and dynamic. The results of steady state simulations were compared against the filtered yearly average performance of the plant, and used for preliminary calibration. The only model parameter value changed at this stage was the ferric to phosphorus molar ratio in chemical phosphorus precipitation. The default 1.6 molFe/molP was adjusted to 3.5 to match primary effluent filtered phosphate measurements. The default value is taken from the literature and may not be the most representative for typical municipal plants. More experience is necessary to establish how typical the accepted value of 3.5 is.

Following steady-state simulations, dynamic runs were performed on the whole year's dataset. Based on soluble P measurements and simulation, two parameters have been changed:

Equilibrium ortho-P concentration was changed from 0.01 mgP/L to 0.015 mgP/L. The value of 0.015 mgP/L at pH 7 will result in about 0.01 mgP/L ortho-P concentration at pH 6.7 – 6.8, the operating pH range of the plant. It is likely that the true equilibrium concentration is even lower at the plant, but 0.01 mgP/L is the detection limit of the analytical procedure. Choosing the best value for this parameter requires more experience as well.

Nutrient P content of the three active biomasses (autotrophs, non-poly-P heterotrophs and anoxic methanol utilizers) was reduced from the default 2.2% to 1.5%. When the simulation was run with the default value (2.2%), the plant model experienced frequent and severe nutrient (P) limitation affecting nitrification and BOD removal. The nutrient limitation and the resulting spikes in BOD and ammonia occurred in spite of the phosphorus stored in chemical precipitate form being bioavailable through redissolution. It is typical that microorganisms that grow in a low nutrient environment adapt to the nutrient deficient conditions and contain less P (or N) than biomass grown on typical municipal influent without chemical addition.

Three other parameters were changed based on circumstantial evidence.

The nitrification growth rate was reduced from the default 0.9 d⁻¹ to 0.8 d⁻¹, and the autotrophic DO switch was increased from 0.25 to 0.5 mgDO/L. There is not enough information in the effluent ammonia concentration from the Nitrification stage (which is always fully nitrified) to be able to peg the value of this parameter down. The estimation is based on the minimum nitrification growth rate that the model must use in order to predict full nitrification occurring during the winter in accordance with observations. This

value will also predict well nitrification occurring in the Secondary stage, under operating conditions in 2002, and under the new, seeding configuration in 2004. It has to be recognized that nitrification can be limited due to DO availability in the Secondaries. This is taken into account in an approximate way but detailed aeration modeling would be necessary to provide a better estimate of the DO effect. The uncertainty in the DO levels can be handled in the model using a higher DO saturation switch (0.5 mgDO/L was selected).

The Anoxic Methanol Utilizer Maximum Specific Growth rate was reduced from the default 6.4 to 2.7. In the current model 2.7 d⁻¹ causes about 6-7% of methanol to bleed (i.e. increasing the methanol dose would not lead to higher denitrification rates), and the effluent nitrate concentrations are well matched both for 2002 and for the new seeded configuration.

2.8 STEADY-STATE RUN

Steady-state simulations were run with the yearly average filtered data for 2002. Measured values and model predictions for several sample locations are listed in tables below.

2.8.1 PRIMARY EFFLUENT

Percent solids removal was calculated to match primary effluent solids. On the East Primaries, 40% removal was used, while on the West 33% on a yearly average. These numbers are not representative for the typical removal efficiency that can be expected from the primaries, since the average solids data includes several upsets, deteriorating the yearly average performance.

Primary effluent concentrations are shown in **Table 7**.

TABLE 7. PRIMARY EFFLUENT CONCENTRATIONS

	East PE	model	West PE	model
TSS	110.2	110.0	98.4	99.2
VSS	93.1	89.5	81.3	79.7
BOD	111.1	110.7	97.4	94.0
TP	2.3	2.5	2.3	2.1
TSP	0.84	0.96	0.99	0.69
TKN	27.2	27.6	21.4	21.3
NH3	17.7	17.2	12.5	14.9

The “Ferric dose/P removed” ratio has a major influence on primary effluent soluble phosphorus. The value selected was 3.5 molFe/molP. On the East side, yearly average TSP in the Primary Influent is about 1.5 mgP/L, and in the Primary Effluent it is 0.8 mgP/L. With the yearly average flow of 192 MGD, and about 7000 gallons of ferric added, this is approximately 15 kmol P/d removed by adding 48 kmol Ferric or an Fe/P mol ratio of 3.2.

On the West side, yearly average TSP in the Primary Influent is approximately 1.2 mgP/L, and in the Primary Effluent it is 1.0 mgP/L. With the yearly average flow of 120 MGD, and about 4000 gallons of ferric added, this is approximately 3.4 kmol P/d removed by adding 27 kmol Ferric or an Fe/P mol ratio of 8.0. However the sample location for West Primary Effluent is after the chemical dose, and an unknown fraction of soluble P is already precipitated depending on local mixing conditions. The value of 3.5 gives a good agreement for both sides taking into consideration the higher reliability of the data from the East side.

Secondary Influent samples were also available, but mass balance checks pointed to potential problems with those sampling locations. Plant personnel confirmed that sampling might be suspect and those sample locations were not used in the calibration.

2.8.2 SECONDARY EFFLUENT

Secondary Effluent values were generally well reproduced by the model as shown in the following table:

TABLE 8. SECONDARY EFFLUENT CONCENTRATIONS

	East SE	model	West SE	model
TSS	26.0	15.8	24.5	18.5
VSS	20.4	11.1	19.3	12.8
TP	0.6	0.4	0.5	0.5
TSP	0.070	0.010	0.044	0.039
TKN	20.1	21.9	14.1	13.8
NH3	15.2	18.6	9.7	10.6
Nox	0.2	0.0	0.3	0.1

Secondary effluent suspended solids is calculated by a percent removal ideal clarifier model. The percent removal was set to those representing normal conditions during the year. This results in the best fit during the dynamic run through the year. Steady state effluent solids are slightly lower in the model since the averaged data includes several periods with higher effluent solids.

Total Soluble Phosphorus (TSP) values are simulated in the model as various orthophosphate ionized species. The values from the plant indicate that the secondary effluent contains very low orthophosphate concentrations, close to or lower than the detection limit. Measurements using lower detection limits (0.01 mgP/L) confirm that the true concentrations are probably even lower. BioWin will predict around 0.01 mgP/L with ferric overdose at the plant pH values until more data is available to accurately determine the real phosphate equilibrium values.

There is partial nitrification occurring in the West side in the model. During the dynamic run the extent of the nitrification is limited by DO transfer, which is not included in steady-state calculations. The nitrified ammonia is denitrified in the plant, probably in non-ideally mixed tanks, channels, and sludge blankets. This is taken into account in the model increasing the simultaneous aerobic denitrification switch in Secondary reactors only (local kinetic parameter). The default value of this switch is 0.05 mgO₂/L – the 0.45 mgO₂/L value selected will produce secondary effluent nitrate concentrations very close to the measured low concentrations at the plant for two operating conditions: 1) 2002, when no nitrifying sludge was recycled back to the Secondaries 2) 2004, with nitrifying sludge wasted back to the West side of the Secondaries.

2.8.3 NITRIFICATION EFFLUENT

Nitrification Effluent concentrations are well reproduced in the model (see notes about suspended solids and soluble P at the secondary effluent).

TABLE 9. NITRIFICATION EFFLUENT CONCENTRATIONS

	Nitr. Effl Odd	model	Nitr. Effl Even	model
TSS	4.8	3.6	4.6	3.5
VSS	3.8	2.7	3.8	2.6
COD	21.2	19.4	18.0	19.2
SCOD	13.6	15.5	14.1	15.5
BOD	6.6	2.2	5.7	2.1
SBOD	2.0	1.1	2.0	1.1
TP	0.17	0.09	0.13	0.09
TSP	0.065	0.012	0.061	0.012
TKN	1.81	1.7	1.67	1.7
NH3	0.41	0.2	0.39	0.1
Nox	5.5	4.6	4.4	5.1

The higher TSP values in the data are caused to a large extent by the higher detection limit (0.05 mgP/L), and partially by a few elevated datapoints during the year that are not represented in a steady-state run.

2.8.4 MIXED LIQUOR

MLSS values are well represented in the model (after adjustment of the East wastage rates as discussed in the Wastage section above). MLVSS values are slightly underpredicted, except in the East Secondaries. There are several factors that influence ISS generation in BioWin 2.1 for this particular configuration:

- Influent inorganic suspended solids, ISS – this is measured on the plant as the difference between influent TSS and VSS.
- Chemical inert solids generation. This mainly depends on the chemical dose and not too much on precipitation efficiency (the unused ferric will still precipitate as hydroxide solids). There is uncertainty in the literature at the moment regarding the contribution of chemical solids to VSS. Some of the hydrated precipitates that form will convert to oxides at 600C° and cause an apparent VSS component.
- Inert suspended solids generation due to biomass growth. This constant was set to 0 for DCWASA. By default BioWin 2.1 generates 8% inert solids for every unit of biomass grown.

Given the uncertainties in the influent COD data affecting MLVSS, the wastage and the various inert fractions that are present in the MLSS, it was decided not to change default model parameters without further investigation.

TABLE 10. AVERAGE SOLIDS CONCENTRATIONS AT THE PLANT

	MLSS	model	MLVSS	model	VSS%	model
West Odd	2484	2426	1953	1669	0.79	0.69
West Even	2669	2299	2097	1603	0.79	0.70
East	2812	2674	2215	1881	0.79	0.70
Nitrification Even	1758	2114	1414	1543	0.80	0.73
Nitrification Odd	1616	1997	1290	1477	0.80	0.74

2.9 RESULTS OF THE DYNAMIC SIMULATION

A full year-long dynamic simulation was run based on filtered daily data provided by the plant. The starting point for the run is the yearly steady-state discussed above.

All important concentrations and other parameters were imported into the BioWin Album and displayed in Time Series plots. Continuous lines are simulation results by the model, while measured data is represented by squares.

In February a significant portion of flow was diverted from the West Primaries to the East (2 charts)

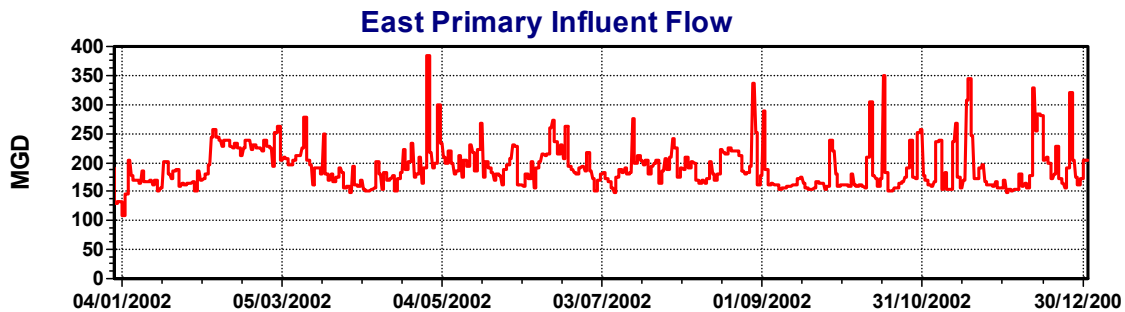

FIGURE 2. EAST PRIMARY INFLUENT FLOW

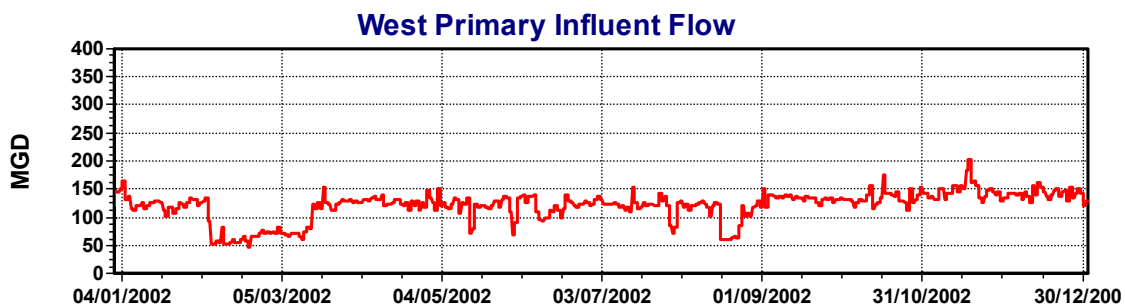

FIGURE 3. WEST PRIMARY INFLUENT FLOW

Temperature change through the year (1 chart)

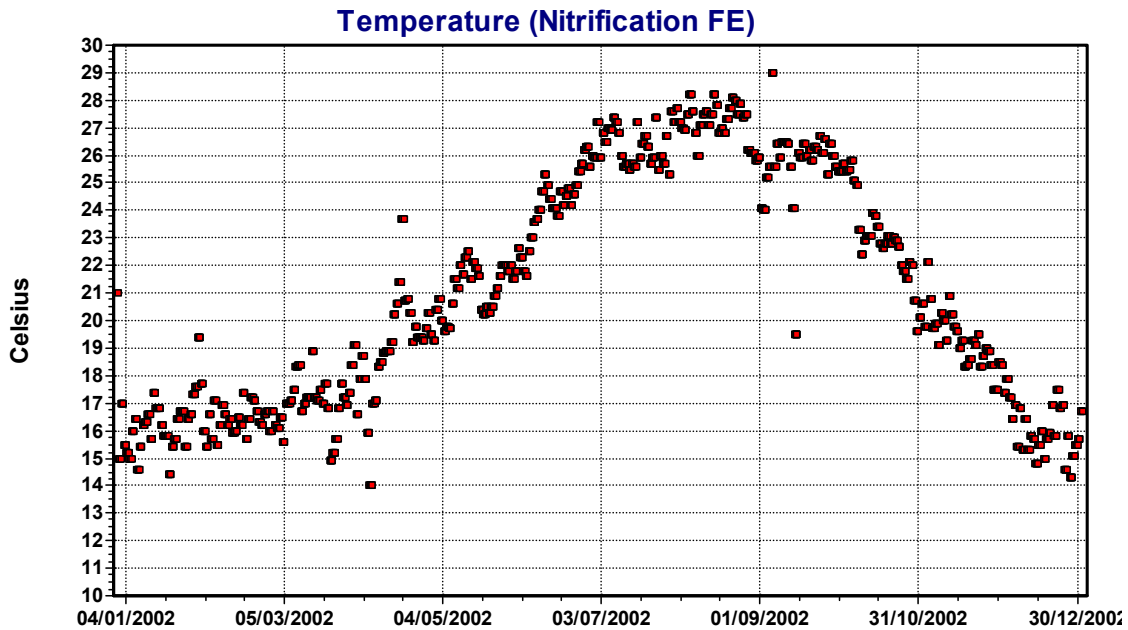

FIGURE 4. TEMPERATURE (NITRIFICATION FE)

East Secondary and Nitrification wastage flows were adjusted based on the steady-state calibration (5 charts)

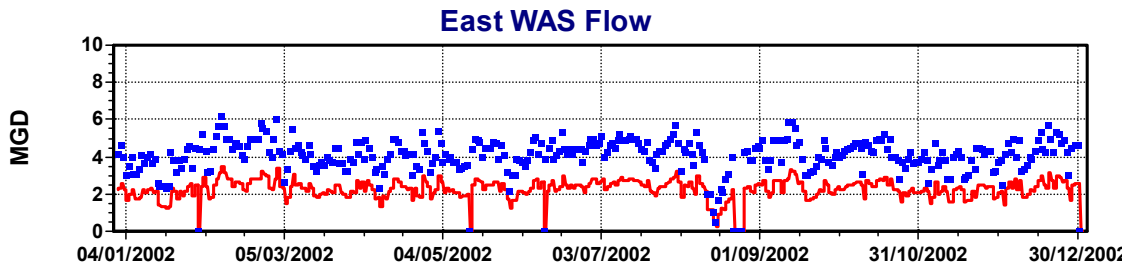

FIGURE 5. EAST WAS FLOW

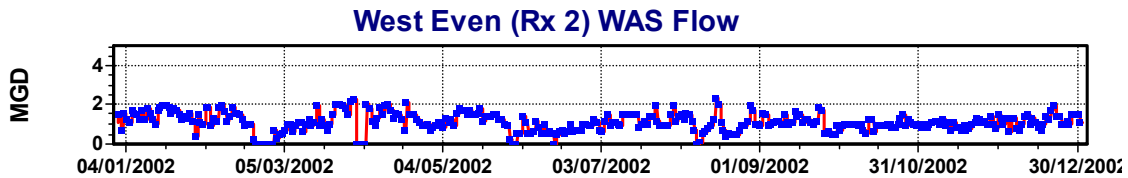

FIGURE 6. WEST EVEN (RX 2) WAS FLOW

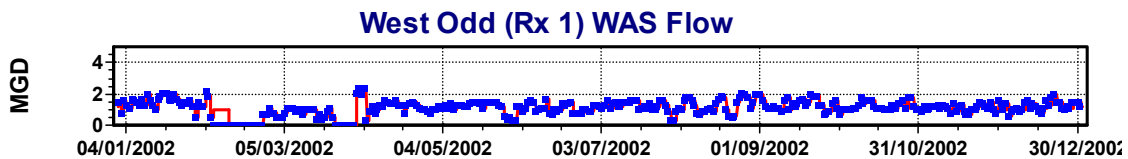

FIGURE 7. WEST ODD (RX 1) WAS FLOW

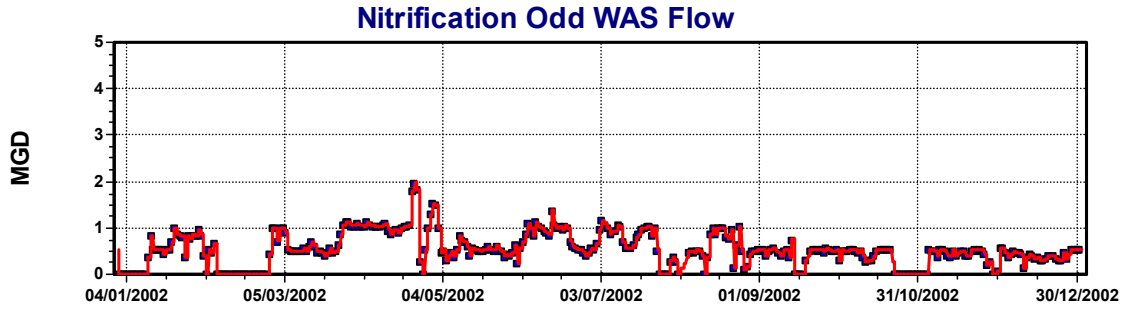

FIGURE 8. NITRIFICATION ODD WAS FLOW

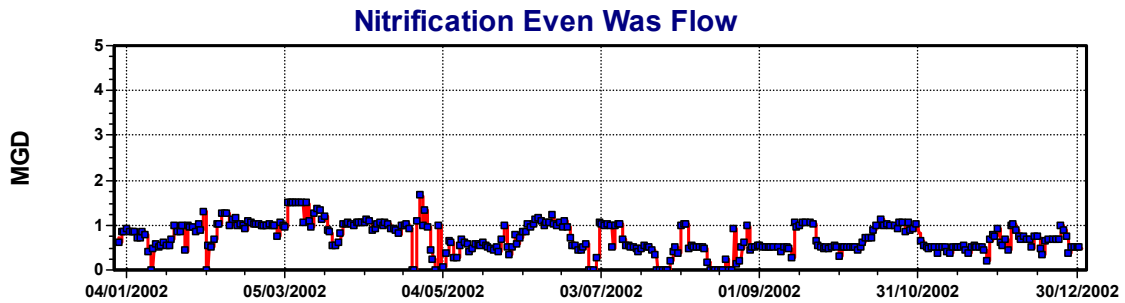

FIGURE 9. NITRIFICATION EVEN WAS FLOW

Primary influent VSS and TSS values as recalculated by the model based on the influent fractionation and the assumed COD (2 charts).

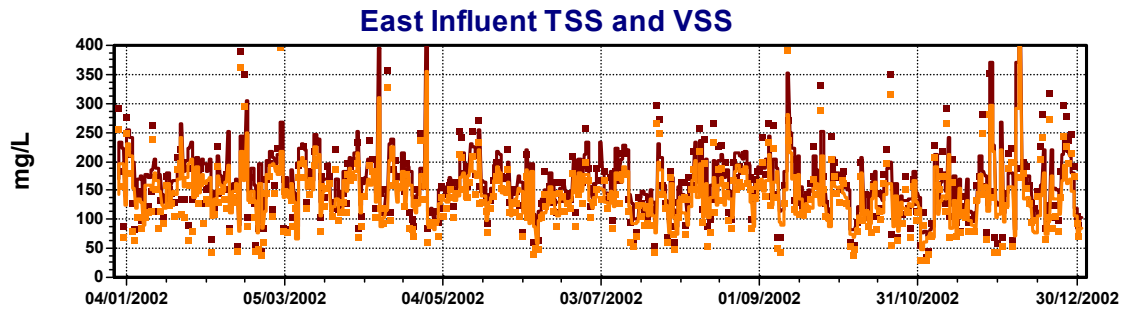

FIGURE 10. EAST INFLUENT TSS AND VSS

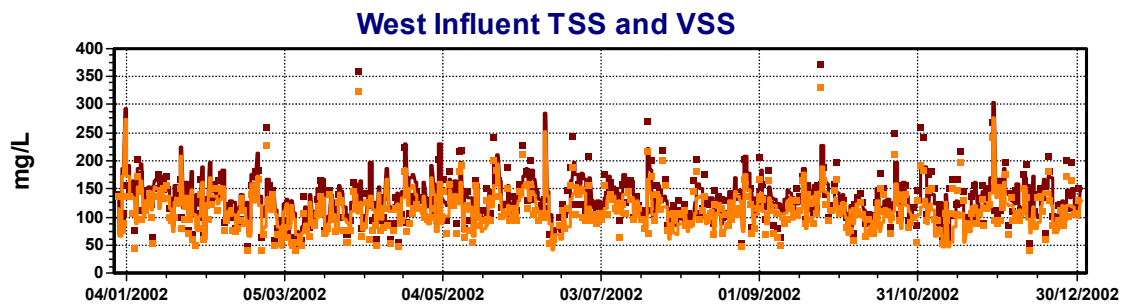

FIGURE 11. WEST INFLUENT TSS AND VSS

Primary effluent TSS concentrations (2 charts). The percent removal model does not account for spikes that are not associated with increased loading.

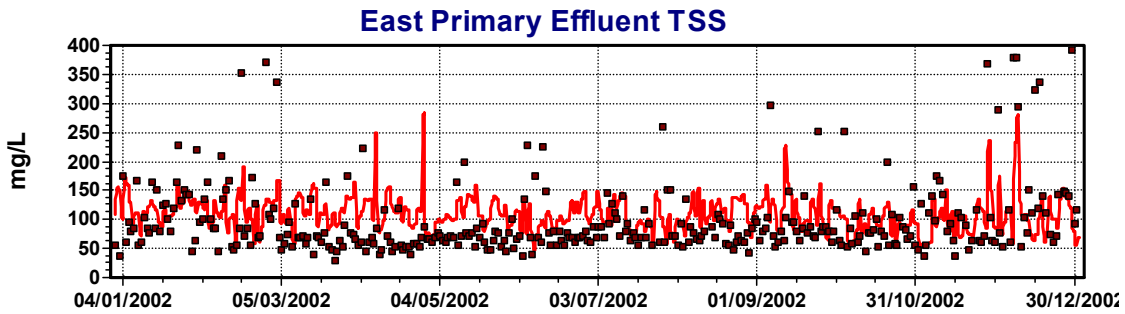

FIGURE 12. EAST PRIMARY EFFLUENT TSS

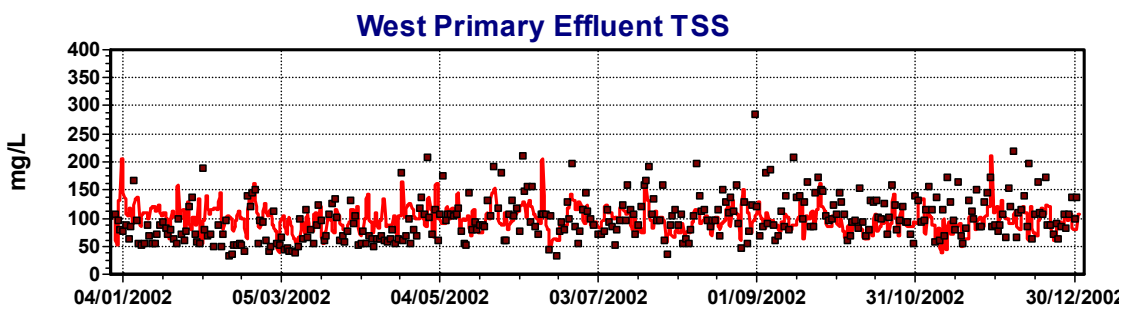

FIGURE 13. WEST PRIMARY EFFLUENT TSS

Primary effluent phosphorus (TP and TSP) concentrations show a very good match (2 charts).

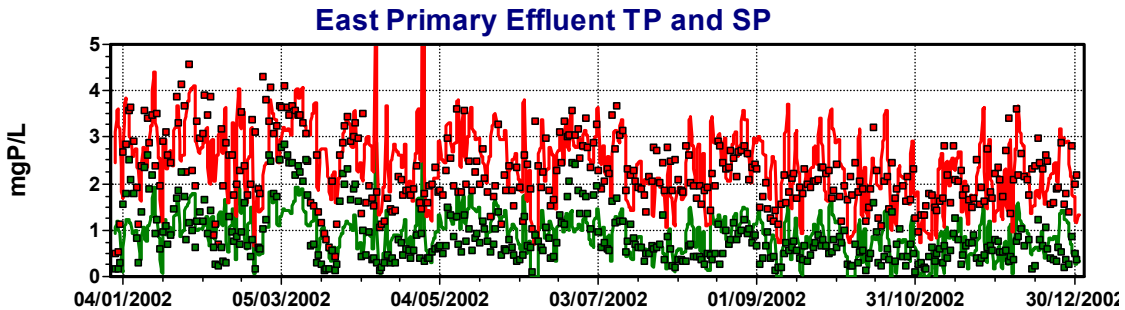

FIGURE 14. EAST PRIMARY EFFLUENT TP AND SP

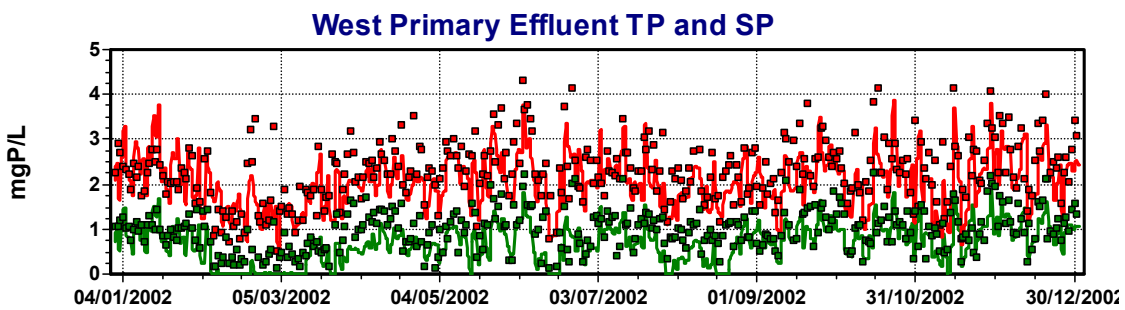

FIGURE 15. WEST PRIMARY EFFLUENT TP AND SP

Reactor activated sludge MLSS concentrations (5 charts). The model matches the trend except in February when part of the West secondaries were shut down and the flow transferred to the East. Some of the solids return flows were completely shut down in the database, while MLSS was still maintained in the reactors.

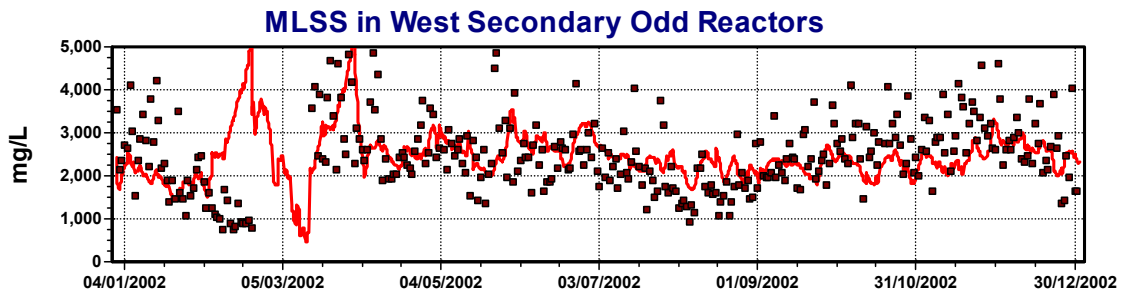

FIGURE 16. MLSS IN WEST SECONDARY ODD REACTORS

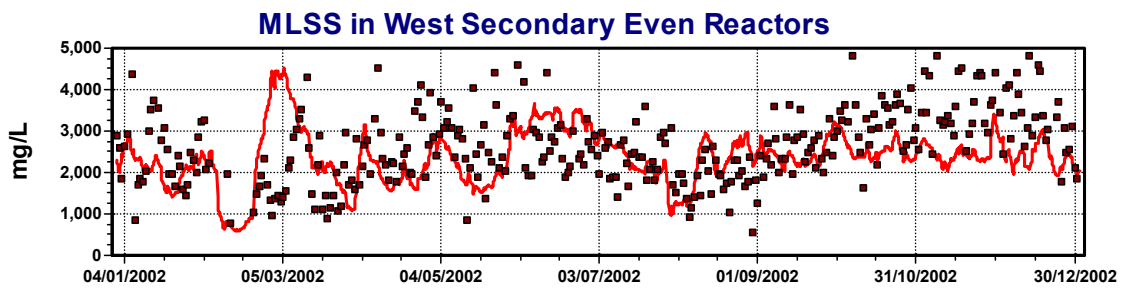

FIGURE 17. MLSS IN WEST SECONDARY EVEN REACTORS

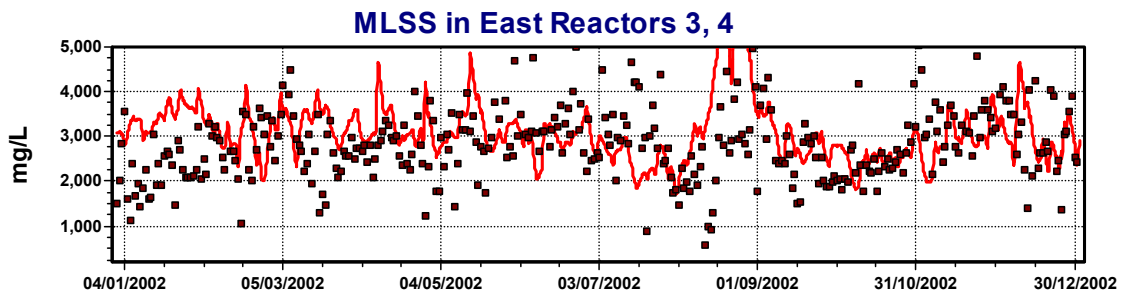

FIGURE 18. MLSS IN EAST REACTORS 3, 4

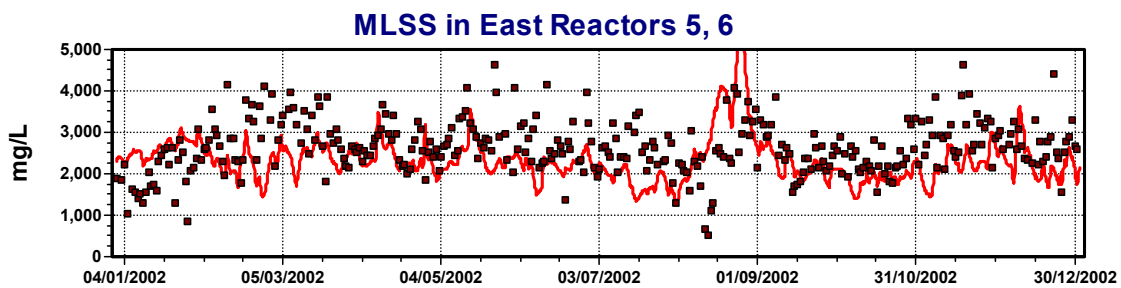

FIGURE 19. MLSS IN EAST REACTORS 5, 6

Secondary WAS TSS concentrations – data available only for part of the year (3 charts).

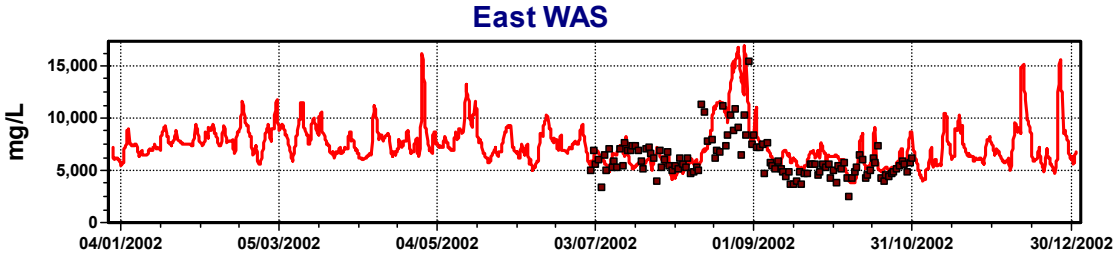

FIGURE 20. EAST WAS

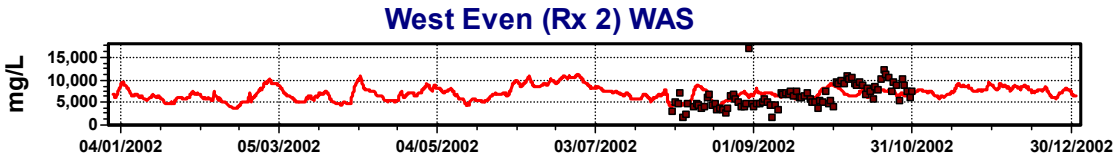

FIGURE 21. WEST EVEN (RX 2) WAS

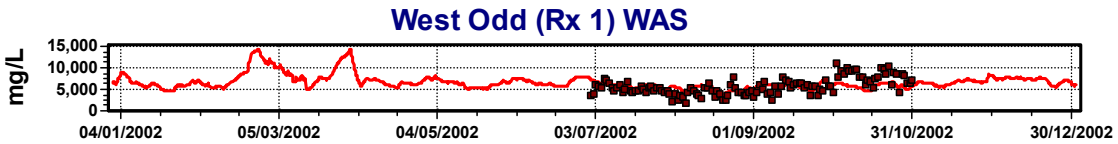

FIGURE 22. WEST ODD (RX 1) WAS

Secondary effluent TSS and BOD values (4 charts). For efficiency effluent TSS is calculated by a percent removal model, which only responds to solids loading changes. BOD measurements are directly related to effluent solids as the soluble BOD component is relatively stable. Some of the upsets in the data are probably due to increased hydraulic loading, sludge blanket problems or changes in settleability. To provide more accurate simulation of these events, the model settler would have to be used. This will cause an increase in model complexity and degradation in computational performance.

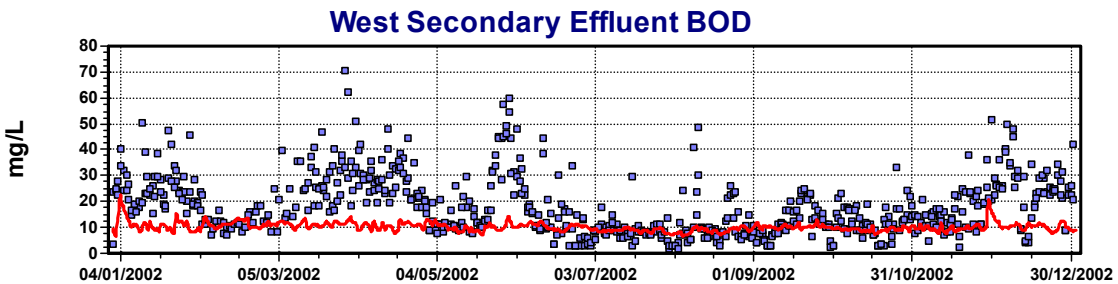

FIGURE 23. WEST SECONDARY EFFLUENT TSS

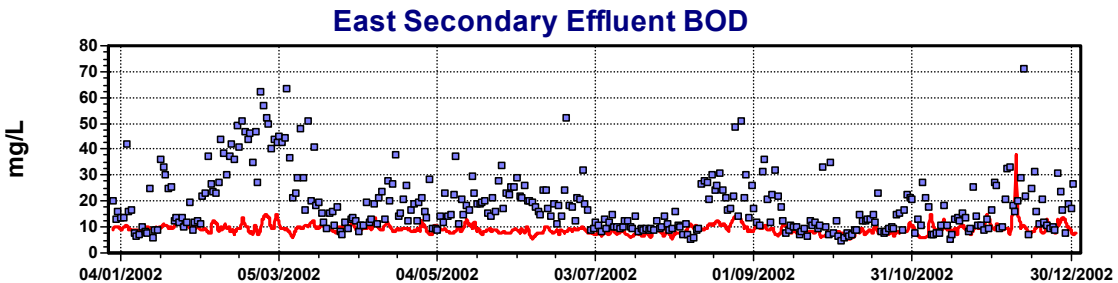

FIGURE 24. WEST SECONDARY EFFLUENT BOD

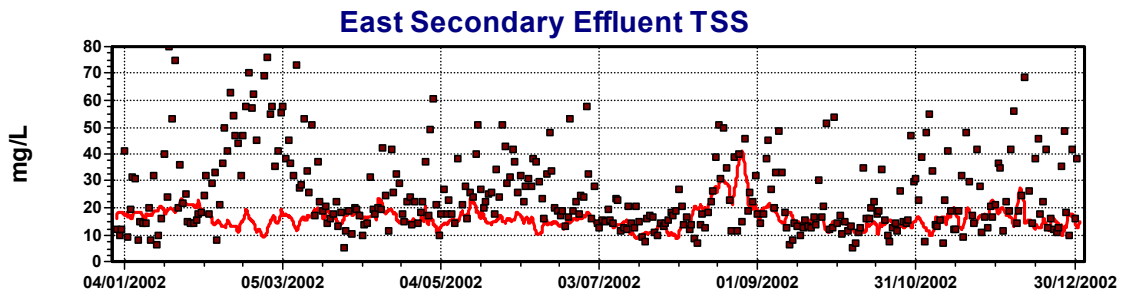

FIGURE 25. EAST SECONDARY EFFLUENT TSS

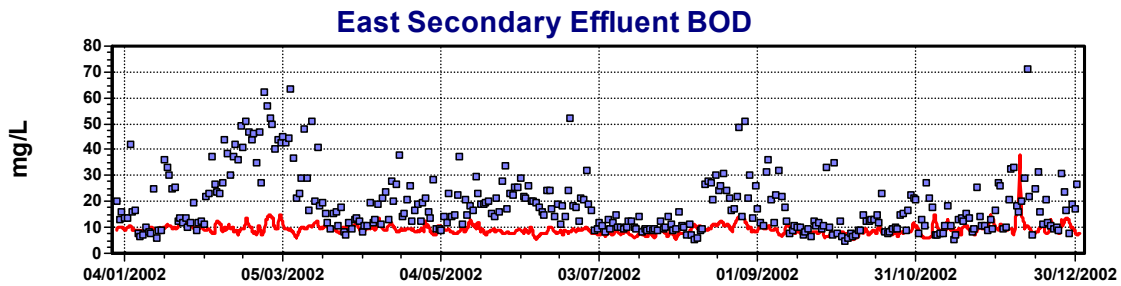

FIGURE 26. EAST SECONDARY EFFLUENT BOD

Secondary Effluent ammonia (2 charts). The model, in agreement with the data, predicts slight nitrification in the West reactors. In initial runs fixed DO setpoints were used and significant nitrification was predicted. To try to find the reason for this difference, the actual air flow to the secondary plant and DO modeling was used. This results in intermittent DO limitation in the Secondaries and a good match in West Secondary Effluent Ammonia.

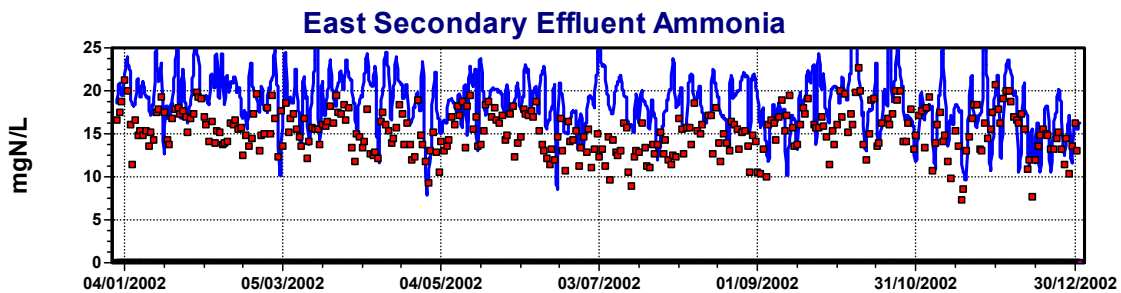

FIGURE 27. EAST SECONDARY EFFLUENT AMMONIA

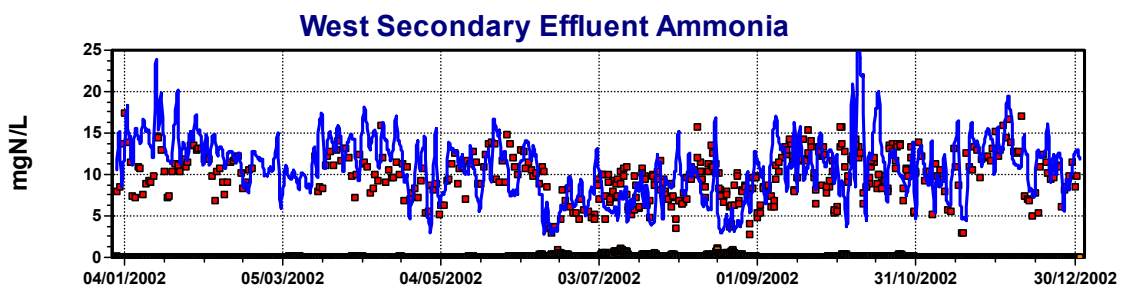

FIGURE 28. WEST SECONDARY EFFLUENT AMMONIA

Secondary Effluent Total Phosphorus is well predicted by the primary settler model with chemical dosing (2 charts).

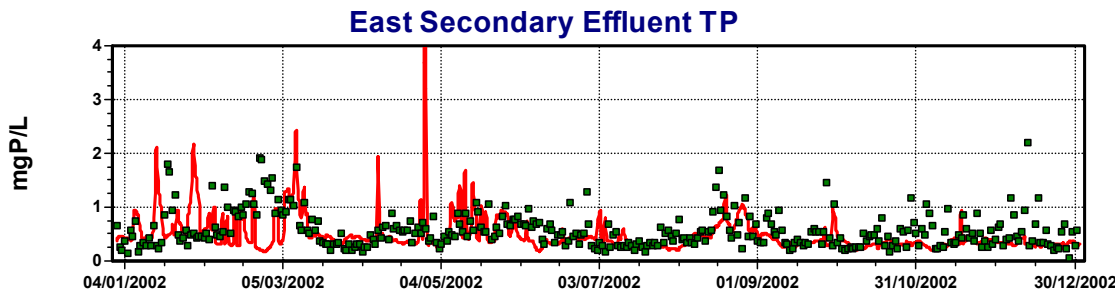

FIGURE 29. EAST SECONDARY EFFLUENT TP

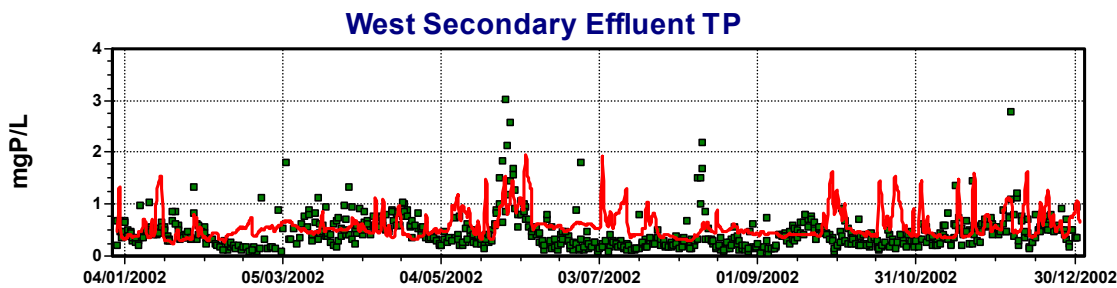

FIGURE 30. WEST SECONDARY EFFLUENT TP

Secondary Effluent Total Soluble Phosphorus (2 charts). The model predicts the equilibrium concentration that is currently set to the detection limit (0.01 mgP/L) at the plant. This detection limit was changed from 0.05 to 0.01 mgP/L in July, 2002. The model also predicts spikes in soluble P when chemical dosage does not exceed the required stoichiometric amount (currently 3.5 molFe/molP). The spikes do not necessarily match up exactly with actual events due to data accuracy and potentially due to the simplifications the model is making (ignoring the role of hydroxides and organics in PO_4 adsorption, coagulation, flocculation).

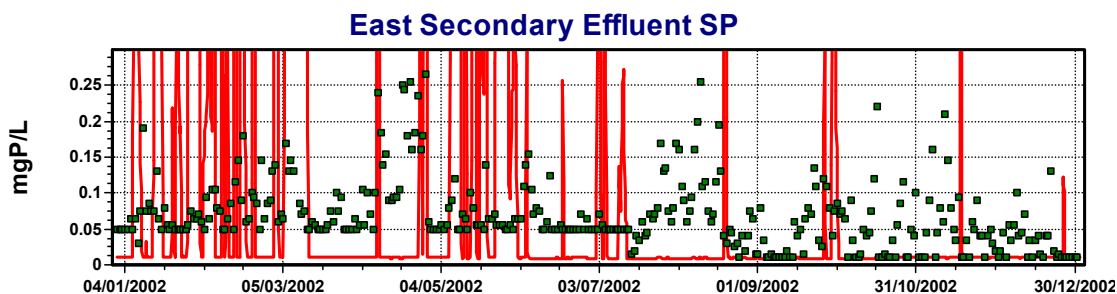

FIGURE 31. EAST SECONDARY EFFLUENT SP

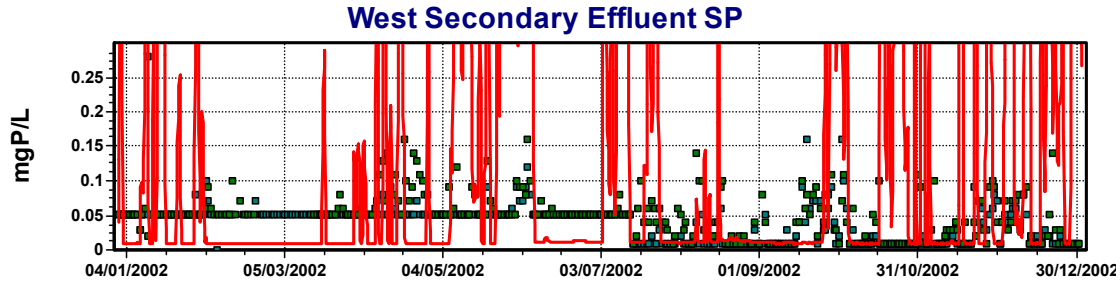

FIGURE 32. WEST SECONDARY EFFLUENT SP

MLSS in Nitrification trains (2 charts). The average and trend is well predicted, except during the February upset when the Nitrification Stage did not receive the proper solids loading in the model.

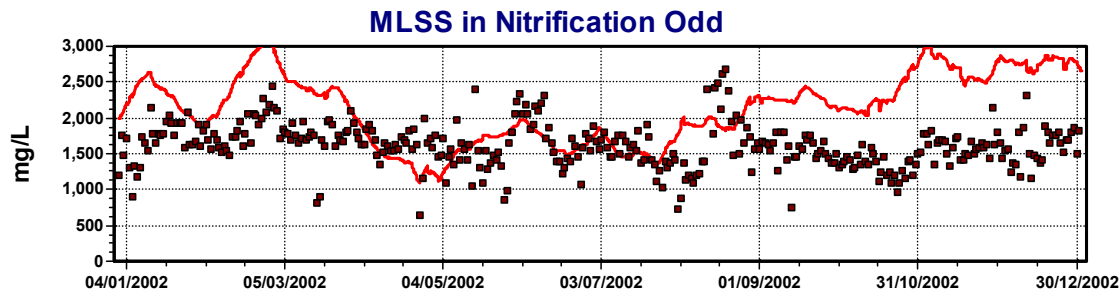

FIGURE 33. MLSS IN NITRIFICATION ODD

Album page - Nitr MLSS

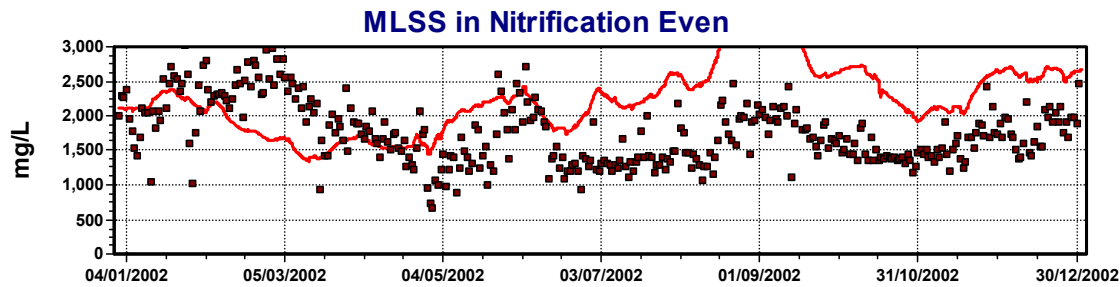

FIGURE 34. MLSS IN NITRIFICATION EVEN

WAS concentrations in the Nitrification Stage (2 charts).

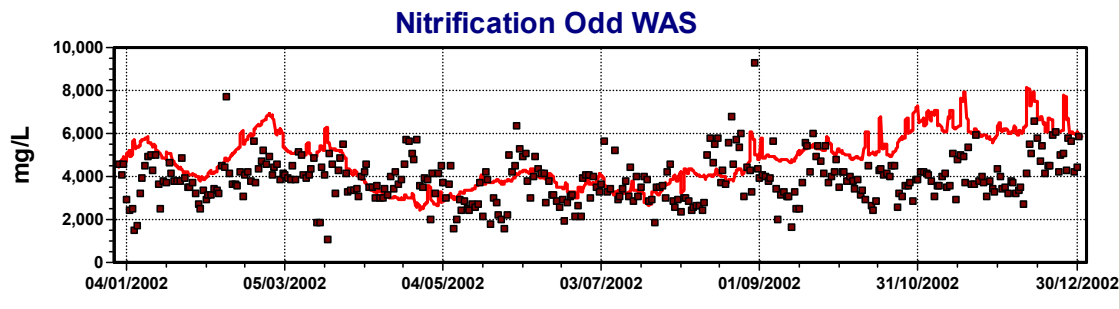

FIGURE 35. NITRIFICATION ODD WAS

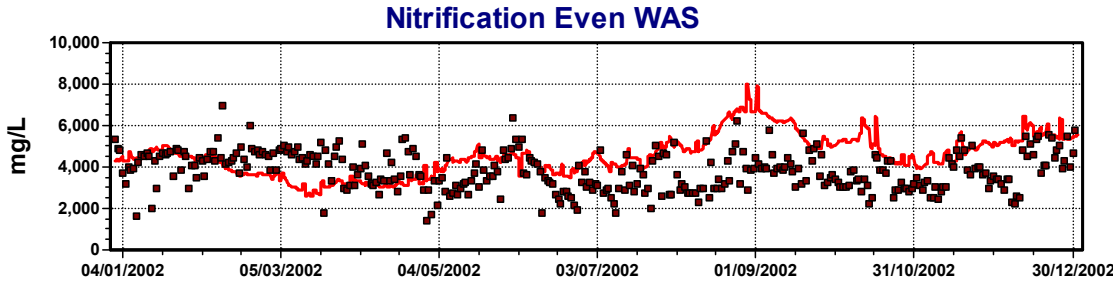

FIGURE 36. NITRIFICATION EVEN WAS

Nitrification effluent ammonia and nitrate (2 charts). Both ammonia and nitrate are well predicted with default nitrification and anoxic methanol utilizer parameters in the model.

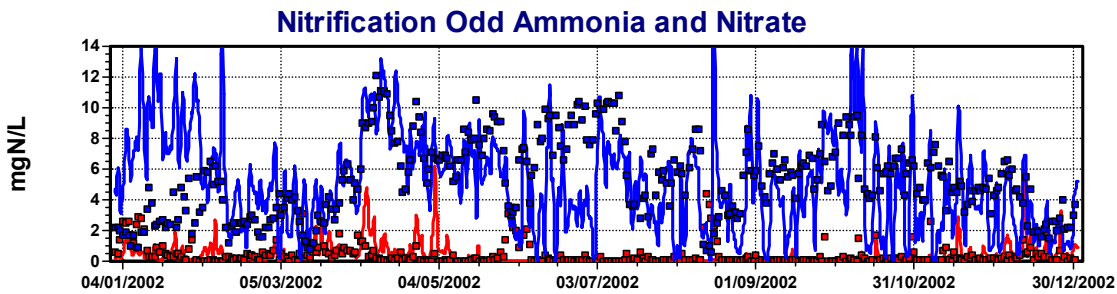

FIGURE 37. NITRIFICATION ODD AMMONIA AND NITRATE

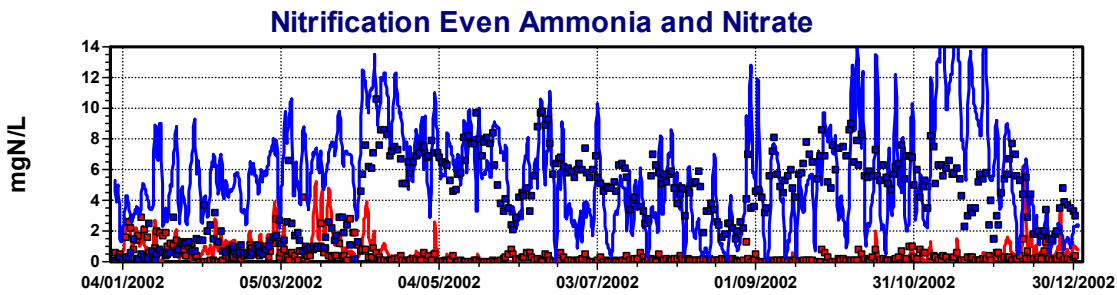

FIGURE 38. NITRIFICATION EVEN AMMONIA AND NITRATE

Nitrification TP and TSP concentrations (2 charts). In 2002 TSP was measured with a detection limit of 0.05 mgP/L. The model considers the same 0.01 mgP/L equilibrium concentration as in the Secondary process.

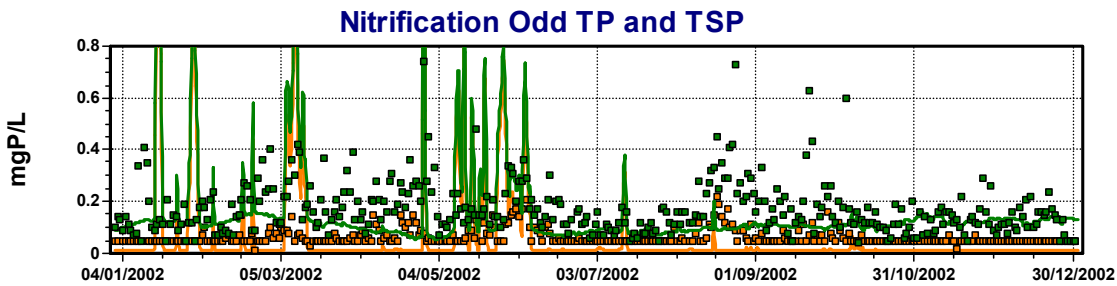

FIGURE 39. NITRIFICATION ODD TP AND TSP

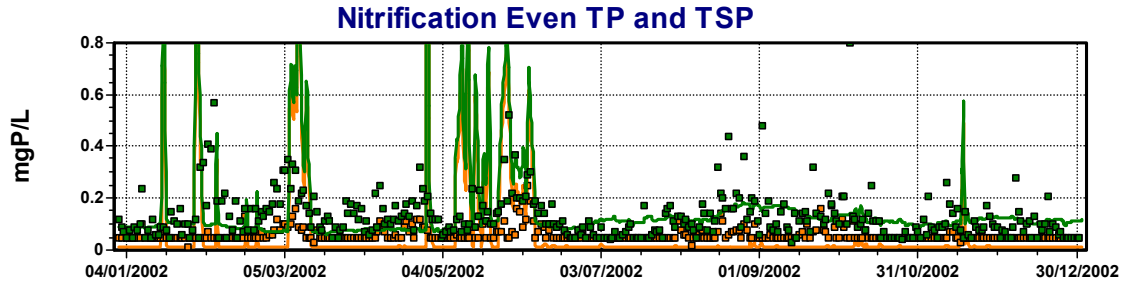

FIGURE 40. NITRIFICATION EVEN TP AND TSP

Nitrification effluent suspended solids (2 charts). The effluent solids, out of the ideal clarifier model, tracks the trend reasonably, with the exception of the February MLSS excursion.

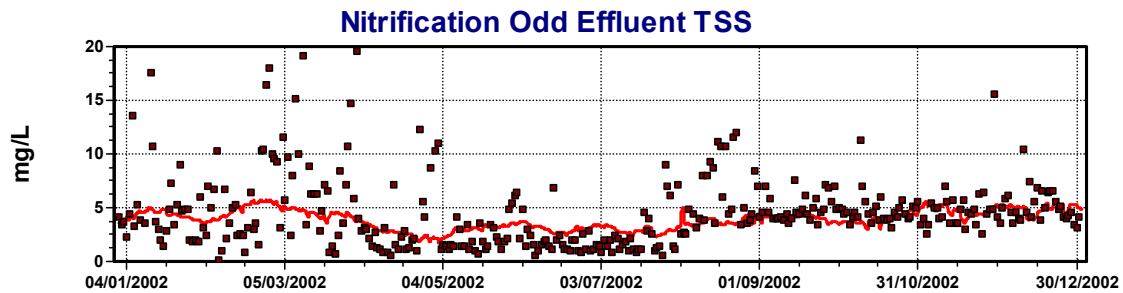

FIGURE 41. NITRIFICATION ODD EFFLUENT TSS

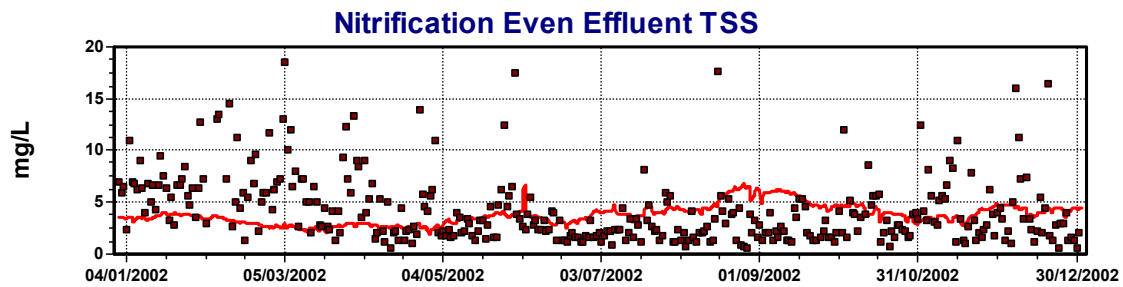

FIGURE 42. NITRIFICATION EVEN EFFLUENT TSS

SRT in the Secondary and Nitrification Stages through 2002 (2 charts).

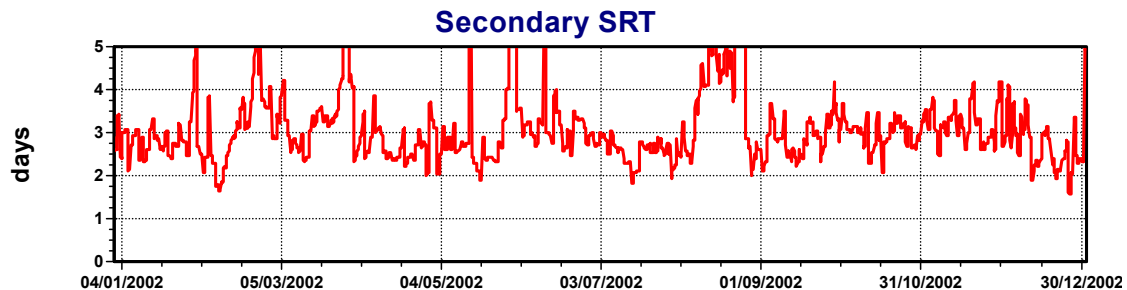

FIGURE 43. SECONDARY SRT

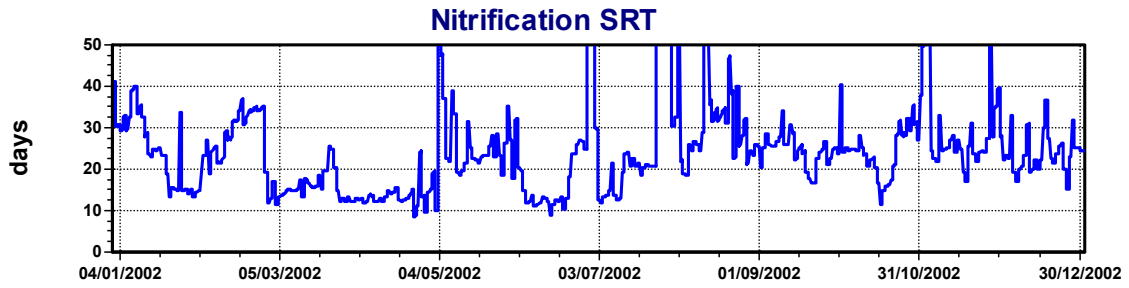

FIGURE 44. NITRIFICATION SRT

CHAPTER 3: MODELING GUIDANCE

The objective of this chapter is to provide guidance for plant personnel and consultants who wish to conduct modeling and simulation studies using the DCWASA 2002 calibrated model. The model can be used in its current form, after updating the relevant operational and influent loading parameters to actual conditions.

There are three BioWin configurations and three related Excel spreadsheets supplied with this report:

4. DCWASA 2002 calibration (.bwc and .xls files). This contains the 2002 full dataset (daily and yearly average data after data filtering), and the calibrated model.
5. DCWASA full (.bwc and .xls files). This contains the full configuration for the plant. Dynamic data has been stripped from the files to reduce size. This is a convenient configuration to start detailed steady-state or dynamic modeling studies on the plant.
6. DCWASA simple (.bwc and .xls files). This configuration is simplified to one Secondary and one Nitrification train. Dynamic data has been stripped from the files to reduce size. It can be used for quick scenario analysis or as a source for future simulations that do not require the full detail of the large layout. It is significantly faster than the full configuration.

All three configurations contain an Album page that (after a steady-state run) can be directly copied to the relevant Excel spreadsheet for easy access to the most important process indicators. For details please see guidance in the Excel spreadsheets. The full configuration as implemented in BioWin can also be used as a starting point for simplified configurations for specific studies.

The BioWin 2.1 model matches well with data provided by the DCWASA plant (Blue Plains). Default parameters were used in the configuration except in the following cases:

- In **nitrification kinetics**, a growth rate of 0.8 d^{-1} was used instead of the default 0.9 .
- The **Autotrophic DO** switch was increased to 0.5 mgDO/L .
- In **anoxic methanol utilizer** growth kinetics, a growth rate of 2.7 d^{-1} was used, instead of the default 6.4 d^{-1}
- In **chemical phosphorus removal** a molar ratio of $3.5 \text{ [molFe / molP removed]}$ was used instead of the default 1.6 .
- The **equilibrium** PO_4^{3-} concentration at pH 7 is set to 0.015 mgP/L from the default 0.01 mgP/L ,

- ***P content*** of active biomasses (autotrophic, heterotrophic and methanol utilizer) was set to 1.5% from the default 2.2%.
- In the Secondaries, an ***aerobic denitrification switch*** of 0.45 mgO₂/L was used instead of the default value of 0.05.
- ***Synthesis ISS*** (ash content of biomass) was set to 0% from the default 8%.

To obtain accurate modeling results, the most important parameters to identify are the influent COD fractions.

A number of assumptions and simplifications had to be made during the construction of the plant model and the calibration process. The most important ones are as follows

1. Individual reactors and clarifiers were combined into five trains.
2. Flow splits that are not measured were considered equally distributed
3. The sludge line is simulated using simple phase separation elements (DAF, centrifuges)
4. DO setpoints were used throughout the plant. Actual blower capacities were implemented in the Secondary Stage, resulting intermittently in lower DOs than the setpoint. Actual diurnal DO changes were not simulated in this project.
5. Data consisted of filtered yearly averages and daily composite samples. No finer, diurnal loading pattern was considered.

3.1 HINTS TO ACCELERATE MODEL PERFORMANCE

DCWASA 2002 calibration.bwc is a large configuration as the plant operates a complex treatment process to achieve the required effluent quality. BOD removal, chemical P removal, nitrification and denitrification using methanol are all included in the process configuration. In order to obtain a model that performs reasonably, several simplifications have been implemented as described above. Other considerations for steady-state and dynamic runs are described below.

3.1.1 STEADY-STATE RUNS

Steady-state simulations are useful for quick evaluation of plant performance. In order to easily compare a large amount of measured data with simulation results for DCWASA, a link was developed between Excel (DCWASA 2002 calibration.xls) and BioWin (DCWASA 2002 calibration.bwc). The “Summary Table” in the Biowin Album can be copied into the Excel Tab called “BioWin Table”. The values are linked to the appropriate locations in the Summary Table in Excel, allowing easy comparison of simulation results to measured data. A section of the table might look like this after the update:

West PE	model	
	116.3	
98.6	98.4	#
81.3	78.3	#
	200.7	
	76.5	
97.4	98.8	#
	45.0	
2.3	2.1	#
0.989	0.718	#
21.4	20.7	#
12.5	12.6	#
143.1	155.5	#

Model results are displayed on the right side in yellow. Measured data is on the left, in white columns. The goodness of fit is indicated by a green or red # sign, depending on settings on top of the tab.

Steady-state convergence of large plants in BioWin is faster if instead of the BioWin hybrid method the Decoupled Linear Search method is selected in the Project – Current Project Options – Numerical Tab.

The Hybrid method uses both Newton-Raphson (NR) and the Decoupled Linear Search (DLS) method as required to minimize the number of search steps. The time required for one step in the NR algorithm is proportional to the square of state variables (i.e. very large in large plant models), while the time required by DLS is linearly related to the number of state variables. In small/intermediate configurations the Hybrid or NR is a quicker method, while in large configurations DLS is faster.

3.1.2 DYNAMIC RUNS

The dynamic run for 2002 was performed on daily flow and concentration values. Output was collected with a 4 hour database interval to increase execution speed. More frequent data collection for plotting in the album might be necessary for simulating more dynamic events.

The dynamic run was started from the yearly average steady-state conditions. Depending on the computer, the full year run can take between 30-72 hours to execute. Simulation of specific events and steady-state runs take a much shorter time and in some cases might be more practical to perform for engineering studies.

The simulation speed is mainly determined by three factors:

1. The size of the configuration. For a specific process question, consider simplifying the configuration as described above. A much simpler configuration (DCWASA Simple) is attached to the report that can be used for analyzing the behavior of the plant.
2. The number of model options that are switched on. pH and chemical P removal modeling particularly are computationally intensive and should be used only when the simulation job specifically requires it.
3. Dynamics in variables with low concentration. Typical example is DO, methanol and nitrate in anoxic tanks. Hitting CTRL-D on the BioWin drawing board will bring up an advanced status report form. This will identify the variable that at the given moment is limiting the step size, consequently the speed of the simulation. DO can be disabled by deselecting DO modeling (if the calculations do not require it).

APPENDIX

Following is a list of files that are a part of this calibration report.

Filename	Content	Application
DCWASA 2002 report.pdf	This report	Adobe Acrobat
DCWASA 2002 calibration.bwc	Model	BioWin 2.1
DCWASA physical.xls	Physical plant data	Excel
DCWASA 2002 calibration.xls	Plant process data	Excel
Ferric dose 2002.xls	Ferric dose	Excel
Influent Specifier – East 2002.xls	Influent fractionation	Excel
Influent Specifier – West 2002.xls	Influent fractionation	Excel
DCWASA simple.bwc	Simplified DCWASA model	BioWin 2.1
DCWASA simple.xls	Steady-state table for simple model	Excel
DCWASA full.bwc	Full DCWASA model	BioWin 2.1
DCWASA full.xls	Steady-state table for full model	Excel

**District of Columbia Water and Sewer Authority
Blue Plains Total Nitrogen Removal /
Wet Weather Plan**

APPENDIX D

**Wet Weather Treatment Technical
Memorandum**

Wet Weather Treatment Technical Memorandum

**Prepared for
DC WASA
by**

**EPMC-1
Metcalf & Eddy
Delon Hampton and Associates
PEER Consultants**

Section One

The Need for a Wet Weather Treatment Facility at DC WASA's Advanced Wastewater Treatment Plant at Blue Plains

Plant Influent Flows

The District of Columbia Water and Sewer Authority (WASA) owns and operates the Advanced Wastewater Treatment Plant at Blue Plains (Blue Plains) in Washington, D.C. Blue Plains provides treatment to combined sewer and sanitary flows from the District of Columbia and sanitary flows from portions of Fairfax County and Loudoun County in Northern Virginia, and Montgomery County and Prince Georges County in Maryland. The service area comprises 725 square miles and approximately 2 million people are served by Blue Plains. The plant is currently rated at an average annual flow of 370 million gallons per day (mgd). A Blue Plains Service area study was completed in December 2003 by the Metropolitan Washington Council of Governments for the Blue Plains Technical Committee and the Blue Plains Regional Committee. The conclusion of the study was that the 370 mgd rated capacity of Blue Plains will be sufficient to provide for the wastewater treatment needs of the service area until the year 2030. Legal agreements provide details on the amount of wastewater from each jurisdiction to be treated at Blue Plains. In addition to Blue Plains, other wastewater treatment plants serve portions of the suburban jurisdictions.

The Environmental Protection Agency (EPA) issues an NPDES permit to DC WASA authorizing the discharge of treated wastewater effluent from two outfalls at Blue Plains, as shown in the process flow diagram for liquid treatment processes at Blue Plains (Figure 1-1). During dry weather conditions, sanitary flows are conveyed to Blue Plains and receive complete treatment. During wet weather conditions, both sanitary and storm flows are conveyed to Blue Plains in a combined sewer system up to a peak rate of 1,076 mgd. A wet weather event begins at Blue Plains when the influent flow rate exceeds 511 mgd. Plant influent flows at rates up to twice the rated capacity ($370 \text{ mgd} \times 2 = 740 \text{ mgd}$) receive complete treatment during the first four hours of a wet weather event and flows at rates up to 511 mgd receive complete treatment during the remainder of the event. During wet weather events, plant influent flows at rates above 740 mgd during the first four hours of the event, and at rates above 511 mgd thereafter, are called "excess flow". Excess flows receive preliminary and primary treatment, disinfection, and dechlorination and are discharged to the river through Outfall 001. The permitted flows are summarized in Table 1-1. Outfall 001 is classified as a combined sewer overflow related by-pass.

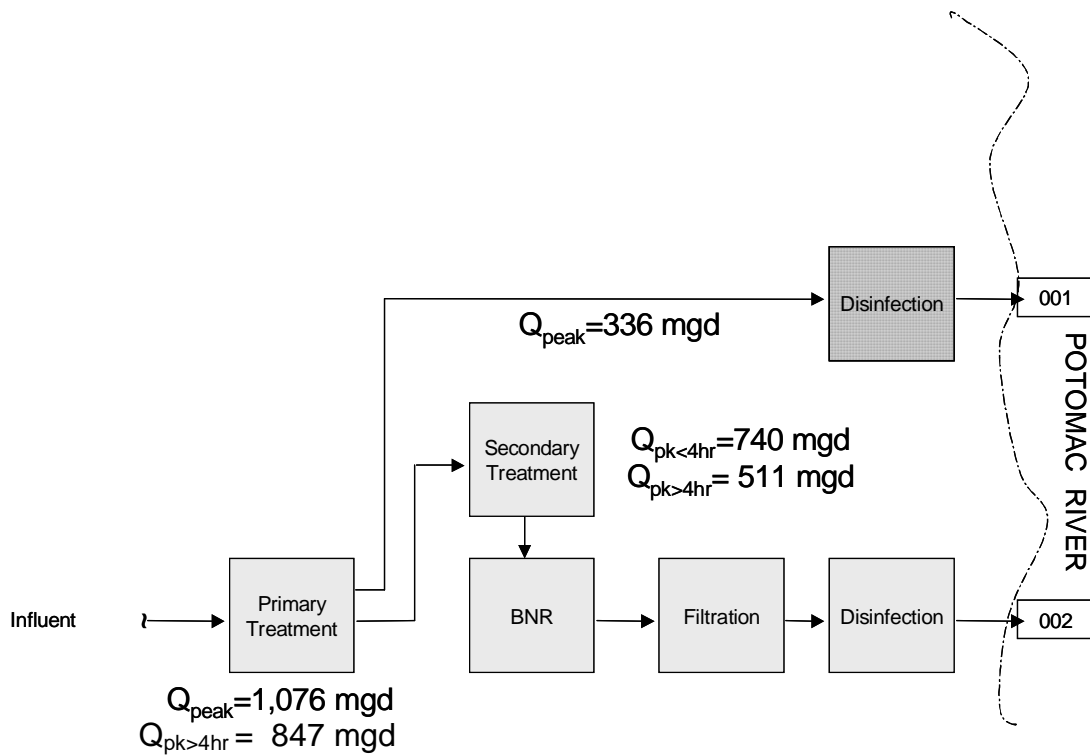

Figure 1-1
Process Flow Diagram for Liquid Treatment Processes at Blue Plains

Table 1-1 Blue Plains AWTP Permitted Flow Requirements 2003-2008¹		
	First Flush from Wet Weather Storm ²	Average Day Flow after the First Flush and during normal conditions
Average Annual Daily Flow (ADF)		370 mgd
Maximum plant influent	1076 mgd	847 mgd
Maximum flow through all liquid treatment processes	740 mgd	511 mgd
Maximum flow through primary treatment, chlorination and dechlorination and discharged through outfall 001	336 mgd	336 mgd

¹Does not include special provisions for conditions during construction of major unit processes.

²Four consecutive hours after the plant influent flow exceeds 511 mgd.

The Long Term Control Plan (LTCP), which was developed and approved under the assumption that Blue Plains would remove total nitrogen to meet an annual goal of 7.5 mg/l. The intent of projects described in the LTCP was to deliver additional combined sewer flow to Blue Plains thereby reducing combined sewer overflows. Specific collection system projects included installation of tunnels in the collection system to store combined sewer flows and rehabilitation of collection system pumping stations.

Also included in the LTCP was construction of four additional primary sedimentation basins at Blue Plains to improve the reliability of the treatment process. The LTCP recommended plan recognizes that the proposed excess flow improvements do not address the impacts of the plan on nitrogen removal at Blue Plains.

Evaluation of Primary Treatment

The ability of the plant to reliably and efficiently meet the final TN limit of 4.2 mg/l begins by optimal performance of the preliminary and primary treatment processes at all flow conditions because the enhanced nutrient removal (ENR) processes are sensitive to excursions of flow, high solids and BOD loading. The preliminary processes, influent screening and grit removal processes have recently been upgraded and have the capacity to meet the permitted flow conditions.

The capacity of primary treatment facilities is determined by a combination of criteria, which include depth, surface area and detention time. There are 16 primary sedimentation basins in the west process and 20 primary sedimentation basins in the east process. Forty percent of the plant influent flow is treated in the west process up to its maximum capacity of 296 mgd. The remaining flow is treated in the east process; therefore, the east process treats the excess flow. The existing 36 primary sedimentation basins were rehabilitated. The upgraded West Process primary sedimentation tanks provide relatively good levels of total suspended solids (TSS) and biological oxygen demand (BOD) removal up to the 296 mgd capacity of the West Process. Specifically, acceptable performance is removal of fifty percent (50%) of the influent TSS and twenty-five percent (25%) of the influent BOD in the primary process. Performance tests of the rehabilitated primary sedimentation tanks were performed in 2004 at various hydraulic loading rates. The performance results are shown in Figure 1-2. The tests included polymer and ferric chloride addition, which is routinely used for phosphorus removal and improved settling. Table 1-2 presents the detention time and surface overflow rate for the current permitted flows with the existing tanks and with the four additional primary sedimentation tanks called for in the LTCP. The total suspended solids and BOD removal efficiencies for the respective surface overflow rates are included in the table and are based on the results of the performance testing shown in Figure 1-2.

**FIGURE 1-2
EAST PRIMARY SEDIMENTATION PERFORMANCE TEST 2004**

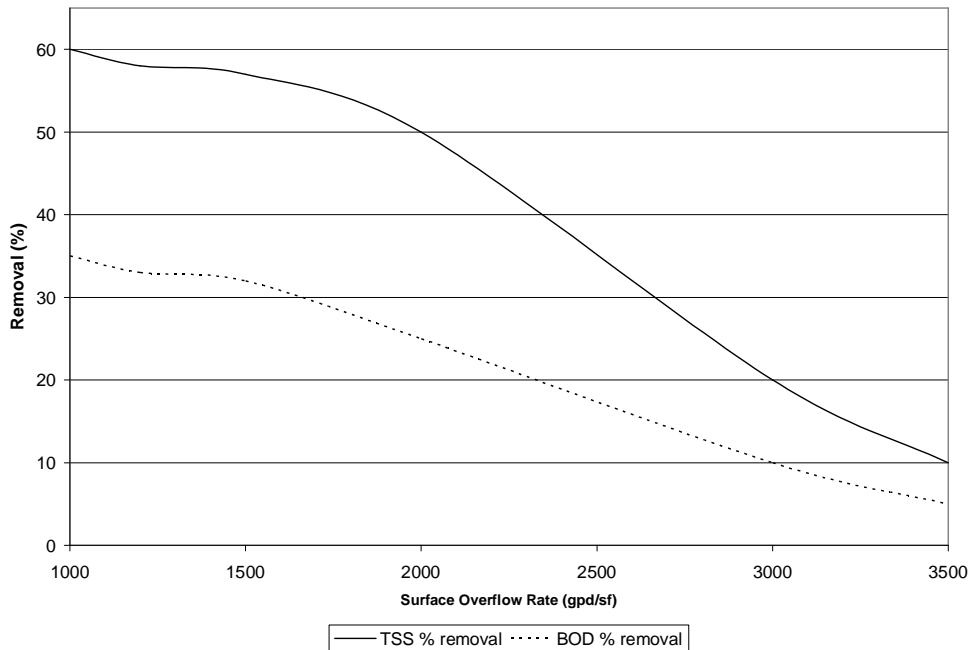

# of East Primary Sedimentation Basins	Peak Primary Influent Flow			East Primary Sedimentation Basins			
	East (mgd)	West (mgd)	Total (mgd)	Surface Overflow Rate (gpd/sf)	Detention Time (hours)	TSS Removal (%)	BOD Removal (%)
Current = 20	780	296	1,076	3,450	0.7	10	5
LTCP = 24	780	296	1,076	2,870		22	11
Proposed = 20*	444	296	740	1,964	1.3	50	25

A separate wet weather treatment facility is proposed to treat excess flow.

The performance declines considerably when influent flows to the plant exceed 740 mgd, as all of this additional storm flow is routed to the East Process. The East Process facilities are significantly overloaded at 1,076 mgd; as noted in Table 1-2, the overflow rate is greater than 3,400 gpd/sf. The TSS removal efficiency at 1,076 mgd is approximately 10%. The existing primary treatment facilities are not adequately sized for flows greater than 740 mgd and cannot provide the level of treatment required for enhanced nutrient removal during storm events.

Recommendation for Separate Excess Flow Treatment Facility

The LTCP recommended four additional primary sedimentation tanks. However, the LTCP was developed and finalized in July 2002, before the state tributary strategies,

prepared in 2004, identified the need to achieve higher levels of nitrogen removal. Adding four primary sedimentation tanks would reduce peak overflow rates to 2,875 gpd/sf, which is not sufficiently low to achieve the required target performance for increased nitrogen removal. Providing a separate wet weather treatment facility for plant flows above 740 mgd would limit the peak flow rate to the East Primary facilities to 444 mgd. This flow rate would limit the surface-loading rate to approximately 2,000 gpd/sf, with all 20 tanks in service, during storm events. The separate wet weather treatment facility would provide the benefit of off-loading excess flow from the existing East Primary facilities, which would protect the biological treatment processes during storm events. Alternative wet weather treatment technologies are evaluated in this technical memorandum to determine applicability for a wet weather treatment facility at Blue Plains.

Section Two – Alternative Processes for Wet Weather Treatment at Blue Plains

Introduction

As described in Section One, a separate process for the treatment of wet weather flows could be a more effective means to treat the flow into Blue Plains than treating the excess flow during storm events in the existing primary sedimentation basins, even if four additional basins are constructed. Figure 2-1 is an aerial photo that shows where the four additional basins were to be located. One criterion for a separate wet weather treatment would be the feasibility of locating it in the same space for ease of operation and in consideration of the space constraints at Blue Plains. Section One identified the need to limit the peak flow through the existing 20 east primary basins to 444 mgd, or 111 mgd per set of four tanks. A space-efficient technology is required to provide excess flow treatment up to 336 mgd in an area equivalent to four existing primary basins. Hydraulic loading rates in the separate wet weather treatment should be at least 3 times the hydraulic loading rates of the primary sedimentation basins.

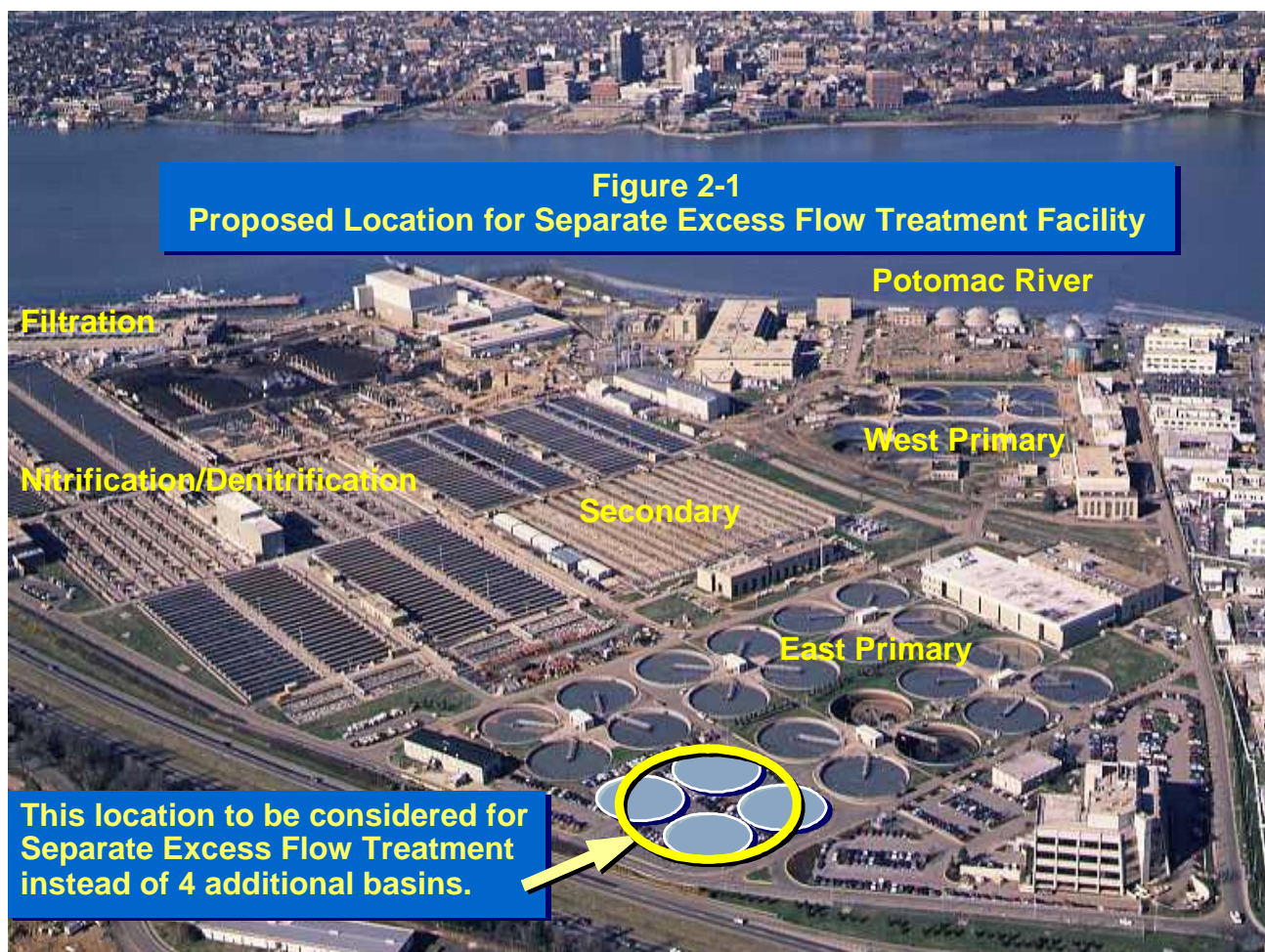

This section includes a description of the three most promising physical-chemical processes for wet weather treatment and summarizes the experiences of other combined sewer systems that use the systems for treatment. The processes are ballasted flocculation and settling and compressible media filtration. Optimization of each process and actual performance of any of the technologies are best predicted by pilot scale operation because every wastewater has unique characteristics that affect performance.

Wet Weather Treatment Alternative Processes

Ballasted Flocculation and Sedimentation Technology

Ballasted flocculation and sedimentation technology provides settling of solids at a higher rate than conventional clarifiers, the advantage of which is that a high level of treatment can be achieved in a smaller footprint. Briefly described, the technology involves addition of chemicals and either microsand or sludge to flocculate fine and colloidal solids followed by clarification. Specific technologies are described in detail in the following sections. While most of the installations in the United States installed by Krüger (Actiflo®) and Infilco Degrémont (Densadeg®) are in water treatment plants, both vendors have provided systems for treatment of combined sewer overflow, sanitary sewer overflow, secondary effluent polishing, and phosphorus removal. Pilot studies on by both manufacturers have shown overflow rates of 50-90 times greater than conventional primary clarification (Leng et al., 2004). Therefore, a ballasted flocculation and sedimentation technology located in the space under consideration could treat flows at rates of significantly greater than 336 mgd. The systems are ideal for wetweather events due to quick start up times and can be used as tertiary treatment for secondary effluent polishing during dry weather (John Meunier, Inc. 2004).

Krüger Actiflo®

The Actiflo® system, developed by Krüger, incorporates high rate flocculation and lamella plate settling to treat water and wastewater. The technology is effective for removal of solids from combined sewer flows. It can be initiated for wet weather treatment and otherwise remain idle as steady-state operations for the process can be reached in under 30 minutes.

In the Actiflo® process, the surface area of microsand (NSF approved inert pure silica sand) is used to enhance flocculation and the weight of the microsand acts as a ballast to increase settling (Leng et al., 2004). Based on these properties, the Actiflo® clarifier is designed for high overflow rates and short retention times, and therefore has a footprint 5 to 20 times smaller than a conventional clarification system designed to treat a similar flow (Krüger, 2004). The system requires an area of approximately 40-80 square feet per million gallons treated per day (Krüger, 2004).

The Actiflo® process is illustrated in Figure 2-2. As wastewater first enters the Actiflo® system, coagulant chemicals are added to destabilize solids and colloidal matter

(Krüger, 2004). Wastewater flows into an injection tank where the microsand as well as a polymer is added for floc formation. The flow is then passed to the maturation tank where light mixing causes polymer bridges to form between the microsand and the destabilized suspended solids and colloidal material. In the settling tank, the microsand ballasted floc rapidly settles and the clarified water rises up through either inclined plates or tube settlers and exits the Actiflo® process for disinfection or further treatment.

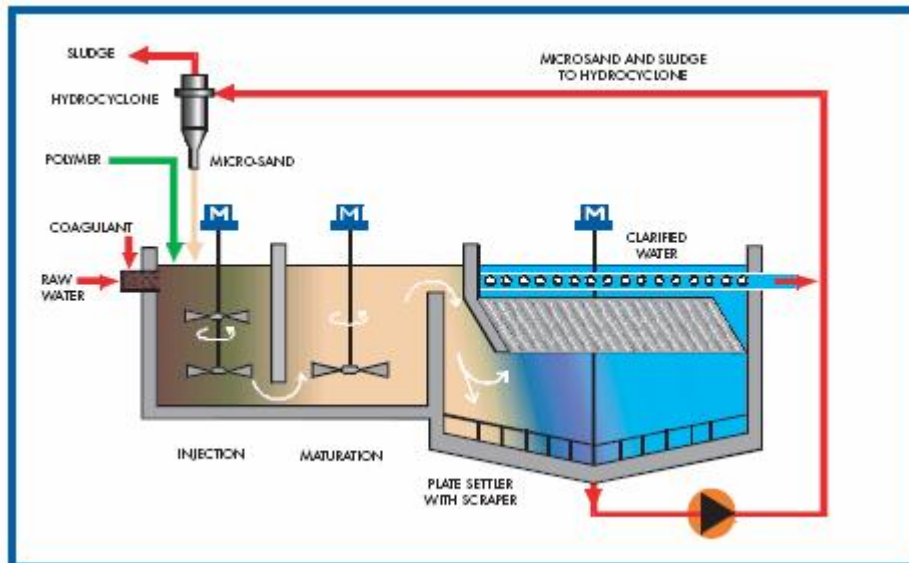

Figure 2-2
Actiflo® process flow diagram (Krüger, 2004)

The particle and microsand mixture at the bottom of the clarifier is transferred to hydrocyclones where the microsand is separated by centrifugal force and recycled for reuse in the Actiflo® process and the remaining sludge can be sent to the gravity thickeners with the primary sludge (Leng et al., 2004). Typical sand loss with the sludge is 2 mg/L of treated water (Krüger, 2004). In pilot studies the primary sludge concentrations ranged from 3900 to 8020 mg/L (Leng et al., 2004).

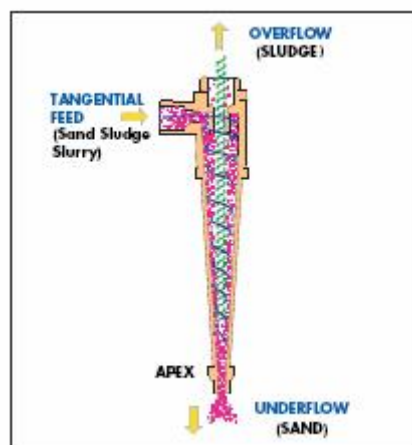

Figure 2-3
Hydrocyclone for Recycling Sand (Krüger, 2004)

Krüger specifies several design criteria parameters for wastewater treatment with Actiflo®. The total retention in the Actiflo process is generally less than 15 minutes with a nominal overflow rate of 50-70 gpm/ft². Recommended microsand size is approximately 150 µm. When not in use the microsand remains in the floc chambers and is immediately available once operation is resumed (Krüger, 2004). The Actiflo® system easily adapts to flows 10-100 percent the nominal design capacity with minimal effect on effluent quality (Krüger, 2004).

Table 2-1
Typical Wastewater Removal Efficiencies by Actiflo®
 (Source: Krüger, 2004; Leng et al., 2004)

Parameter	Removal
TSS	85-95%
Turbidity	97%
BOD (Total)	60-80%
Total P	85-95%
COD	60-80%
Metals	50-90%
Fecal Coliform	>95%
TKN	10-40%

Typical removal efficiencies for wastewater contaminants, as provided by the manufacturer, are shown in Table 2-1. According to the manufacturer, the process consistently displays efficient removals of TSS, BOD, Total P, COD, metals, fecal coliforms, and other typical wastewater contaminants that can be removed by physical-chemical processes (Krüger, 2004). All Actiflo® installations will perform somewhat differently depending on several factors, including influent characteristics, overflow rates, and chemical addition concentrations.

Full scale installations are either currently operating or in construction in Bremerton and Tacoma, WA, Lawrence, KS, and Fort Worth, TX.

Infilco Degrémont Densadeg®

Densadeg® was developed and is marketed by Infilco Degrémont (IDI) and incorporates flocculation, internal (high-density primary sludge particles) and external solids recirculation with tube or plate settling to treat wastewater (Leng et al., 2004). Densadeg® is ideal for applications in which waste sludge volume is problematic because it functions as both a clarifier and thickener. This technology is appropriate for wet weather wastewater flows because the start-up time ranges from immediately to 30 minutes. Due to the high loading rates of the Densadeg® system the space requirements are typically 50% less than conventional treatment processes.

Densadeg® uses two joined tanks, as seen in Figure 2-4, to carry out a seven-step process. Prior to entering the Densadeg® unit, influent must pass through coarse

screening, with a bar rack spacing requirement of ½ in. or less (Infilco Degrémont, Inc., 2004a). Once flow enters the reactor zone, it is combined with coagulants and polymer as well as pre-formed solids recycled from the presettling/thickening zone (Infilco Degrémont, 2002). Flow is directed up through a draft tube where a turbine initiates flocculation. As resettling occurs, the mixture becomes denser and further recirculation occurs. The mixture travels over a submerged weir and enters the presettling/thickening zone where the dense solids separate and settle to the bottom. A slow moving rake aids in further thickening and the release of entrained water. Periodically the thickened sludge (4-8% dry solids) is removed from the bottom of the thickener and generally sent for final dewatering. Additional thickening is generally not required (Infilco Degrémont, 2004c). In the clarification zone, water is polished as it flows upward through the settling tubes and collects in effluent launders above the tubes.

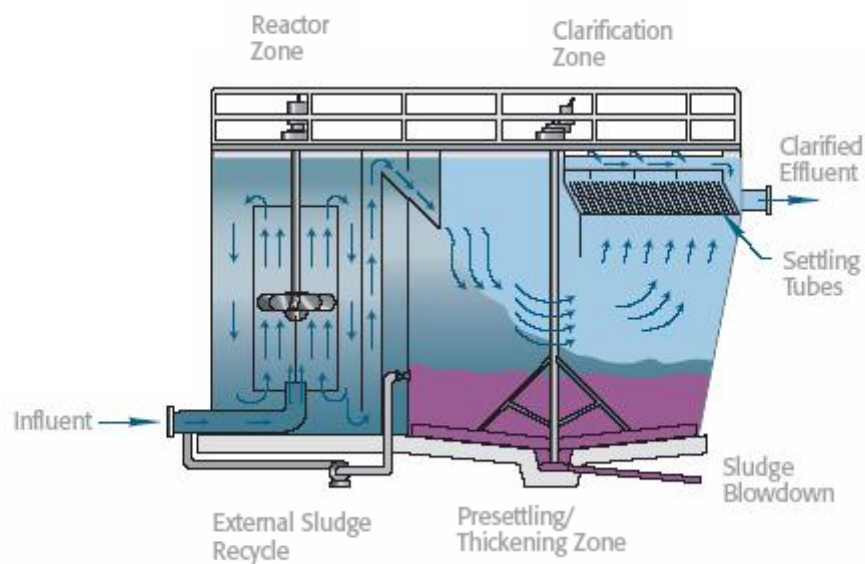

Figure 2-4.
Densadeg® process flow diagram (Infilco Degrémont, Inc., 2002).

Figure 2-5 demonstrates the seven steps in the Densadeg® process. Within the reactor tank, steps 1-3 occur. In step 1, flow enters either an aerated grit chamber or rapid flash mix zone (depending on the required treatment) and coagulant chemicals are added (Infilco Degrémont, Inc., 2004a). Flow then proceeds through a draft tube where polymer is added, and enters the bottom of the reactor in step 2. In step 3, flow enters a transition zone, called the “piston flocculation zone”, between the reactor tank and the clarifier/thickener tank, in which gentle mixing occurs to aid in flocculation.

Steps 4-7 occur in the clarifier/thickener tank. As flow exits the transition zone, step 4 occurs in which grease and other floatables are removed by a skimmer and drain valve (Infilco Degrémont, Inc., 2004a). In step 5, the solids that have been formed settle to the bottom of the tank. Clarified water passes through the lamella settlers in step 6, where remaining solids are removed, and the water is sent to a collection trough, which

discharges to the effluent line. The settled sludge is collected with a bottom scraper in step 7, with some recycled to the base of the reactor zone and the rest pumped out via the waste line.

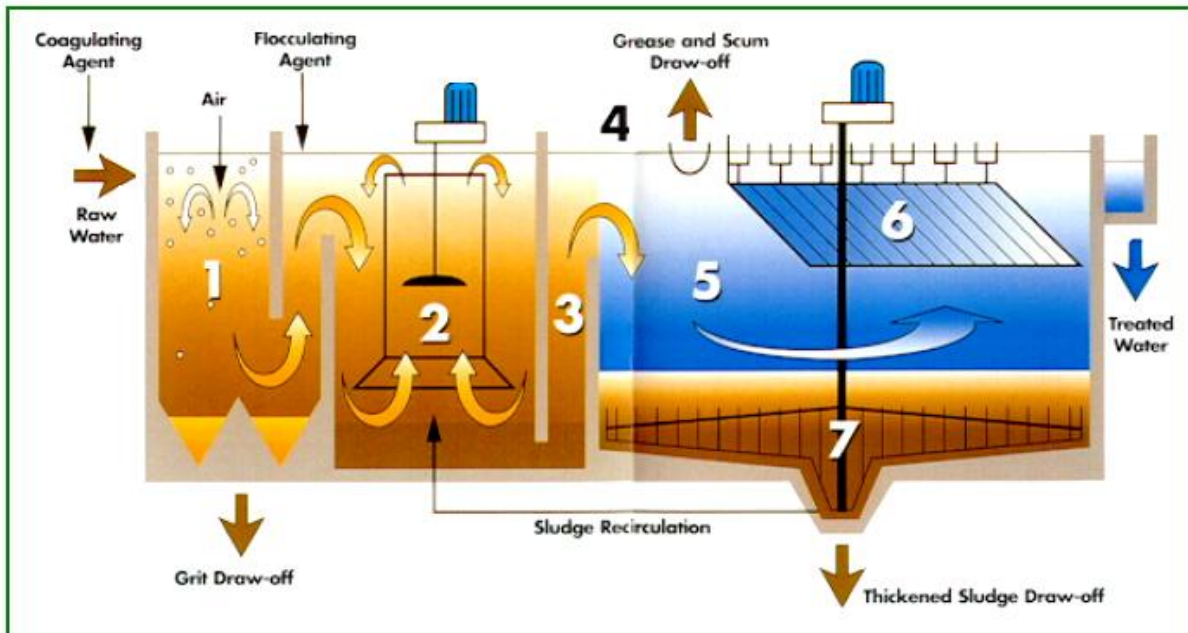

Figure 2-5 Seven Steps in Densadeg® Process

Once wet-weather flows ebb, the Densadeg® unit is shut down and remains full for approximately 6 hours, so that immediate startup is possible in the case of another storm event (Infilco Degrémont, Inc., 2004a). After 6 hours the sludge is removed, however the water is left in the unit for an additional 6 hours, to be ready for any additional wet-weather events during that time. After a total of 12 hours, the unit is drained and can be either left empty or filled with secondary effluent or “clean water” (ground water, river water). If left empty, the next time the system were to be used it would require approximately 20-30 minutes to stabilize, during which time TSS removal would be about 40%. If filled with secondary effluent or other clean water, the system should meet design effluent criteria immediately.

Most of the Densadeg® applications in the United States of America are for water treatment. However, a 232 mgd Densadeg® wet weather treatment facility started operation in November 2006 in Toledo, Ohio. Piloting has been performed in Birmingham, Alabama and San Francisco, California.

Compressible Media Filtration

Compressible media filtration is a technology that includes movable plates that can compress the filter media to change the porosity of the media depending on influent conditions. Currently, there is only one manufacturer, Schreiber Corporation, of a compressible media filtration system for water and wastewater. Solids are collected between the media and thereby removed from the flow stream.

Schreiber Fuzzy Filter®

Fuzzy Filter® produced by Schreiber Corporation is a compressible media filter for water and wastewater treatment. The media is composed of 1.25 in. diameter synthetic fiber spheres (crimped polyvinylidene chloride). The low density and high porosity of the compressible media result in a high rate of solids removal. Compressing the media can vary the pore size and increase the removal efficiency of the filter (until a maximum efficiency is reached) as seen in Figure 2-6, however compression does result in a larger head loss through the filter.

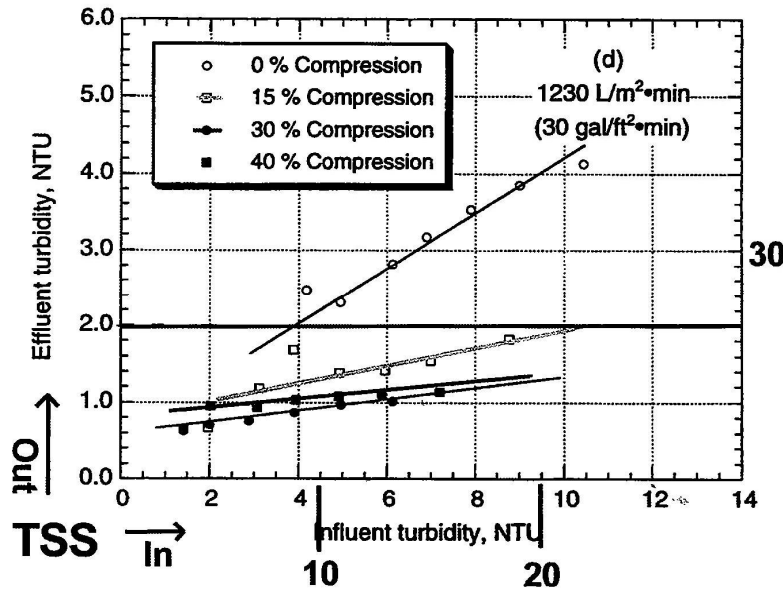

Figure 2-6. Comparison of removal efficiencies at various levels of compression and flow rate of 30 gpm/sf (Caliskaner et al., 1996).

Unlike conventional filters, water is filtered up through the media rather than flowing around the filter material. Conventional filtration systems are often limited to loadings of 2-8 gpm/sf, however with Fuzzy Filters®, a loading of 30 gpm/sf or greater is possible (Schreiber, 2003). Fuzzy Filters® can remove particles as small as 4.5 micron. The filter has three cycles: a filtration cycle, a wash cycle, and a flush cycle as shown in Figure 2-7.

After a filtration cycle is complete, the perforated plates surrounding the media move apart allowing decompression of the media. During the wash cycle, influent can continue to enter the filter and is used as wash water. In addition air scouring is used to clean the media, utilizing an external blower at the bottom of the chamber. Captured solids are continually freed from the media and exit the filter during washing. After the wash cycle is complete, the mixture of freed solids and influent is flushed, the media is recompressed and filtration can begin again.

The filter is available in a range of sizes from 18 in. (0.10 mgd) to 8 ft. (2.8 mgd) square units. The 8 ft. square unit is capable of treating 2.8 MGD at a loading rate of 30 gpm/sf. Clayton County WWTP in Georgia has five 7-foot by 7-foot (30-feet by 30-feet total) capable of 15 mgd (Schreiber, 2005).

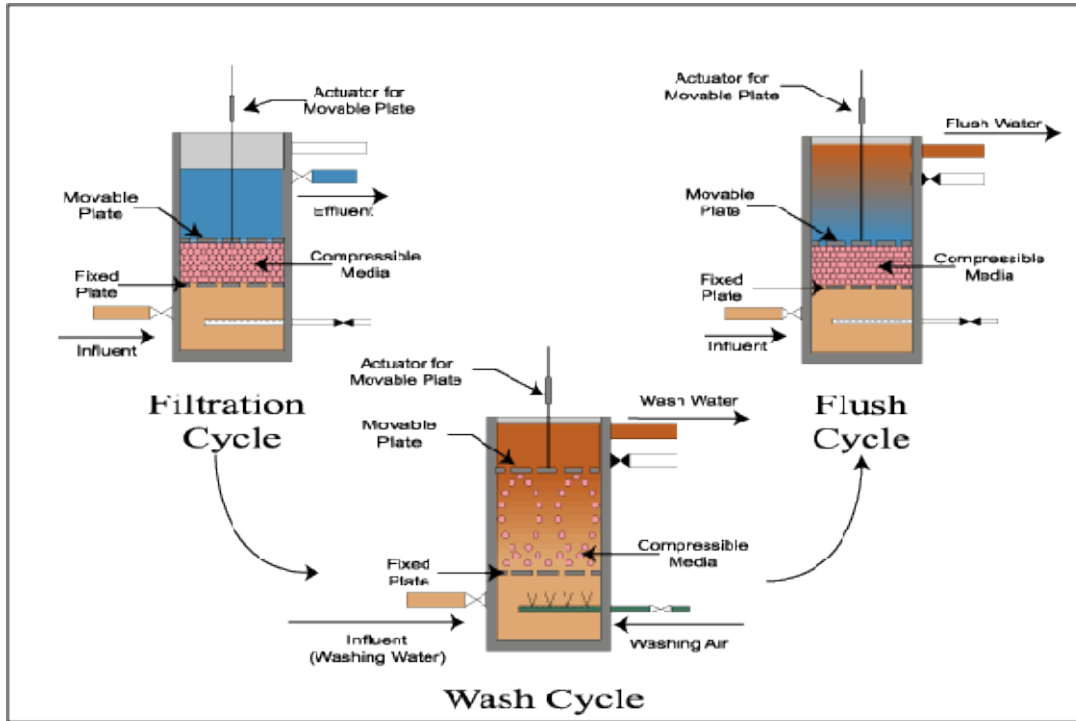

Figure 2-7.
Filtration, wash and flush cycles of Schreiber's Fuzzy Filter®
(Schreiber Corporation, 2003).

Case Studies

Performance

The manufacturers provided lists of installations for each of the technologies previously described in this report. Although the technologies have various applications, this report focuses only on the treatment of combined sewer flows. The design criteria for the full-scale installations are site and permit specific. Table 2-2 presents a summary of the case studies for full-scale installations and Table 2-3 presents a summary of relevant pilot studies.

**Table 2-2
Case Studies for Full Scale Installation¹**

Location	Tech.	Capacity (MGD)	Date Installed¹	Comments
Pine Road Eastside CSO Treatment Facility Bremerton, WA	Actiflo	20	2002	4 CSO events in 2004
Kansas River WWTP Lawrence, KS	Actiflo	40	2003	5 events; 2 mg/l anti-foaming agent, 1.5-2.5 mg/l polymer, 40-45 mg/l FeCl ₃ Plant effluent run through the unit between events to prevent freezing and septic conditions
St. Bernard Parish, LA	Actiflo	10	2001	Sludge is sent directly to gravity thickener
Fort Smith, AR	Actiflo	31	2004	1 event, still requires performance test, effluent goes through complete treatment
Acheres WWTP Paris, France	Actiflo	513	2000	Foaming problems Also used for tertiary treatment to remove phosphorous 60-95% PO ₄ removal 20-80% BOD removal 2-50% TKN removal
Fort Worth, TX	Actiflo	80	Planned 2005	NPDES permit allows blending
Central WTP Tacoma, WA	Actiflo	76	Planned	RFP with performance requirement (86% TSS removal, 68% BOD removal), rather than specified technology. BOD requirement changes if soluble fraction >27%, Max start-up time 30 min
Bay View WTP Toledo, OH	Densadeg	185	Planned	Piloted Actiflo & Densadeg, chose Densadeg based on cost and operational advantages.
Bethlehem Steel Sparrows Point, MD	Actiflo	27.4	2004	Company satisfied with Actiflo performance. Two units.
Columbus, GA	Fuzzy Filter	21	1995	40 events, 30 gpm/sf 68% removal TSS
Rogersville, MO	Fuzzy Filter	1	2002	98% removal BOD, TSS<3ppm, P < 0.5 mg/L
Clayton County, GA	Fuzzy Filter	15	NA	Five 7-foot by 7-foot units, total of 30 feet by 30 feet

¹This table is based on data collected in February 2005. Two of the planned facilities, an Actiflo system in Fort Worth, Texas and a Densadeg system in Toledo, Ohio have since been placed in operation.

**Table 2-3
Case Studies of Pilot Tests¹**

Location	Type	Overflow Rate and Chemical Usage	Removal Efficiency (%)			
			TSS	BOD	TP	TKN
Pine Road Eastside CSO Treatment Facility Bremerton, WA	Actiflo	45 mg/l PACl <1 mg/l anionic polymer	90-95	80	85-90	
Central WTP Tacoma, WA	Actiflo	60 gpm/sf 1.25 mg/l Polymer 725	86-98	38-62		
Mill Creek WTP Cincinnati, OH	Actiflo	40 gpm/sf 45-100 mg/l ferric chloride 1.0-1.3 mg/l Polymer 725	79	48	99	30
		40 gpm/sf 20-90 mg/l Alum 0.9-1.5 mg/l Polymer 725	73	60	90	24
Bayview WWTP Toledo, OH	Actiflo	35-45 gpm/sf 0.8-1.0 mg/l polymer 35-90 mg/l FeCl ₃ 110 mg/l aluminum sulfate	82-94 65-92	50-84* 36-54*		
	Densadeg	20-45 gpm/sf 2.0-2.5 mg/l polymer 50-60 mg/l ferric chloride 60 mg/l aluminum sulfate	74-91 63-86	36-56* 37-79*		
Village Creek WTP Birmingham, AL	Densadeg	60 gpm/sf 45 mg/l ferric chloride 1.5 mg/l polymer	80	47**		
Southeast Plant San Francisco, CA	Actiflo	60 gpm/sf 60-80 mg/l ferric chloride 1 mg/l polymer	70	70**	90-95	20-30
	Densadeg	40-46 gpm/sf 70-90 mg/l ferric chloride 2 mg/l polymer	70	60**	90-95	10-20
New York City, NY 26 th Ward Plant	Actiflo	Good piloting results full-scale demonstration planned	80	55		
	Densadeg		80	55		
Fort Worth, TX	Actiflo	40-70 gpm/sf, 40 gpm/sf recommended 70-125 mg/L ferric sulfate 0.75-1.0 mg/L anionic polymer	70-90	35-65	90-95	25-30
	Densadeg		80-90	38-62	88-95	27-40
King County, WA All run at 60 gpm/sf	Actiflo	110 mg/L Alum 0.95 mg/L polymer (M155)	93	74-93	81	
		200 mg/L PACl 0.95 mg/L polymer (M155)	93	75-87	92	
		110 mg/L Ferric chloride 0.95 mg/L polymer (M155)	94	78-96	92	

*CBOD, **COD

¹This table is based on data collected in February 2005.

Table 2-3 presents a summary of results from the pilot tests. In most instances, piloting was performed to develop an optimization strategy for the technology. Therefore, overflow rates and chemical dosages were modified. For comparison purposes, conditions for similar overflow rates were presented in the table. The nature of wet weather events in combined sewer systems is that they are intermittent and short in duration. For that reason, many utilities used diluted primary influent or primary effluent as the flow source for the piloting.

Table 2-4 presents a summary of metals removal results from Actiflo® pilot studies in King County, WA and Cincinnati, OH. Metals have been successfully removed in steel mill waste streams also (Krüger 2004). Removal is dependant on solubility. Those ions associated with solid particles have higher removal rates.

Table 2-4
Actiflo® Percent Metal Removal of Pilot Tests
(Krüger, 2004)

Metal	King County, WA ¹			Cincinnati, OH	
	110 mg/L Alum	200 mg/L PACl	110 mg/L Ferric	45-100 mg/L Ferric	20-90 mg/L Alum
Aluminum	87	74	97	NA	NA
Iron	92	93	0 ²	NA	NA
Antimony	43	43	18	NA	NA
Barium	87	80	82	NA	NA
Beryllium	NA	NA	NA	NA	NA
Cadmium	71	78	62	NA	NA
Chromium	97	88	85	NA	NA
Cobalt	69	69	0	NA	NA
Copper	96	89	86	92	93
Lead	95	90	96	93	99
Molybdenum	19	18	40	NA	NA
Nickel	56	57	0	NA	NA
Selenium	NA	NA	NA	NA	NA
Silver	94	93	94	NA	NA
Thallium	NA	NA	NA	NA	NA
Vanadium	62	72	90	NA	NA
Zinc	86	79	84	56	48
Mercury	67	83	90	NA	NA

1 All were piloted with 0.95 mg/L polymer

2 Iron based coagulant suspected to leave residual

Pathogen Reduction

An area of specific interest regarding impact on water quality and human health is the impact that the enhanced clarification system would have on pathogens in the combined sewer flow. The proposed enhanced clarification process impacts pathogen removal in two ways. The first is that enhanced clarification removes pathogens and particulates from wastewater. The second is that enhanced clarification reduces turbidity and disinfectant-consuming constituents thereby increasing the effectiveness of subsequent disinfection.

The enhanced clarification process uses coagulant and polymer to form a floc followed by introduction of ballast (sand or sludge) that attaches to the floc to accelerate settling. The settled solids and consequently, the pathogens that adhere to the floc are removed from the wastewater flow. Larger microorganisms such as protozoan, bacteria, and algae (measured in micrometers) would be easily captured as the floc forms and settles. Although viruses are very small (measured in nanometers) some may also be captured during the floc formation and settling. It is important to note that all the microorganisms mentioned above tend to clump together or attach to suspended solids in the environment. Therefore microbes that are associated with particulates would settle out as well. Protozoa, such as *Cryptosporidium* have been found to be removed up to 4 logs (99.99 percent) through enhanced clarification ballasted flocculation (City of Melbourne Ballasted Flocculation and Clarification Study: Gutshall 1999).

Most of the solids particles that can harbor microorganisms, block ultraviolet light, and consume oxidizing chemicals such as chlorine are removed during the ballasted flocculation process (Radick 2001). The lower solids concentration and turbidity in the enhanced clarification effluent would improve the effectiveness of disinfection of that flow.

Chemical disinfectants inactivate microorganisms by destroying or damaging cellular structures, interfering with metabolism, and hindering biosynthesis and growth (Snowball & Horsnsey 1988, Brock 1994). Free chlorine rapidly inactivates bacteria, viruses, and some protozoan cysts, with the exception of *Cryptosporidium* and *Giardia*, at low concentrations. . In addition to pH and temperature, the efficacy of chlorination is primarily dependant on turbidity, and the types of microorganism's present (Gerba, Nwachuku & Riley 2003). Sodium hypochlorite is used for disinfection of the effluent at the Advanced Wastewater Treatment Plant at Blue Plains.

Organisms that would be removed by the enhanced clarification process prior to disinfection are also the organisms most resistant to chlorine. These include the protozoan cysts (*Cryptosporidium* and *Giardia*), the spore forming bacterium (*Bacillus subtilis*), and bacterium with thick waxy outer cell walls (*Mycobacterium* species). The resistance of these microorganisms to disinfection is due to the exterior structures they produce to survive environmental conditions. These microorganisms are very important regarding public health, especially for immuno-compromised individuals. These

organisms of concern, resistant to chlorine, have generally been removed during the enhanced clarification process.

As described above, there is evidence in the literature that treatment of combined sewer flows through an enhanced clarification facility and subsequent disinfection with sodium hypochlorite would produce an effluent with low concentrations of pathogens. Concentrations would depend on chlorine dosage and contact time. Pilot testing using combined sewer flows into Blue Plains during wet weather events would be prudent to validate the expected results (i.e., low pathogens in the effluent).

Considerations

The evaluation of the physical-chemical processes for wet weather treatment indicates that each technology removes particulate matter and does not remove soluble material. The high rate settling processes require a coagulant, polymer and ballast to remove the solids at high overflow rates. Fuzzy Filters® do not require chemicals and the loading rate is half that of the other processes. Grit removal and screening are required upstream of all the processes. Some installations recycle the sludge to the head of the plant while others send it to a thickening process. The sludge is more dilute than sludge from primary clarifiers with the exception of the Densadeg®. Many installations had foam in the effluent stream where it was aerated and some included anti-foaming chemicals in the design. The Fuzzy Filters can remove 25 mg/l of suspended solids because the filter media can store up to 1.20 pounds of solids per cubic feet of media. This level of performance is not adequate for treatment of excess flow at Blue Plains and therefore will not be considered further.

Section Three

Summary of Separate Wet Weather Treatment Evaluation

Benefits of the enhanced clarification facility include improved effluent quality through Outfall 001, improved primary effluent quality due to decreased hydraulic loading on the primary sedimentation tanks, protection of biological systems from wash-outs during wet weather, and more stable biological treatment systems during wet weather events. A summary of expected performance from an enhanced clarification facility, based on the data presented in Section 2, is presented in Table 3-1. In addition to performance data obtained from pilot studies, there are long-term, successful operations of both Actiflo and Densadeg units treating combined sewer flow.

Table 3-1
Expected Removal Efficiencies
Peak Influent Flow = 1,076 mgd

	Flow (mgd)	Surface Overflow Rate (gpd/ft ²)	TSS (% Removal)	BOD (% Removal)
4-Hour Peaking Factor through Biological Processes = 2.0				
West Process Primary Tanks	296	2,097	50	32
East Process Primary Tanks	444	1,964	50	32
Actiflo	225	61,125 ¹	70-94 ²	35-96 ²
Densadeg	225	56,813 ¹	74-91 ²	36-56 ²
4-Hour Peaking Factor through Biological Processes = 1.5				
West Process Primary Tanks	222	1,570	55	40
East Process Primary Tanks	333	1,472	55	40
Actiflo	521	61,125 ¹	70-94 ²	35-96 ²
Densadeg	521	56,813 ¹	74-91 ²	36-56 ²

¹The SOR is approximate and is based on typical design criteria provided by the manufacturers. SOR's are the same for the new units regardless of flow because additional units will be used to treat additional flow (e.g., 10 units to treat 521 mgd vs. 5 units to treat 225 mgd).

²The range of removal rates were obtained from case studies of previous pilot tests that used ferric chloride and polymer.

As identified in Section Two, the ballasted flocculation and sedimentation technologies, Actiflo and Densadeg, would be appropriate for treatment of wet weather flows into Blue Plains. Although Fuzzy Filters have a significantly higher hydraulic loading rate than sedimentation tanks, the solids removal rate, in pounds per square foot makes them inappropriate for this application. In addition, they have no experience operating in large plants.

Pilot testing is recommended to confirm the planning assumptions regarding performance of these systems and to establish design criteria and optimum operations.

References

Caliskaner, Onder and George Tchobanoglous. 1996. "Evaluation of the Fuzzy filter for the Filtration of Secondary Effluent." Department of Civil and Environmental Engineering, University of California, Davis.

City of Bremerton, WA. 2004. "Combined Sewer Overflow Update." http://www.cityofbremerton.com/content/ww_csouupdate.html. Accessed May 6, 2004.

City of Tacoma, Public Works Department. 2004a. "Request for Proposals, Volume I of III, RFP Front End." January 23, 2004.

City of Tacoma, Public Works Department. 2004b. "Request for Proposals, Volume III of III, Draft Schedules to the Draft Design-Build Contract." January 23, 2004.

City of Tacoma, Public Works Department. 2004c. "Upgrade and Expansion Phase III Design-Build Project, RFP Volume III – Schedules to the Draft Design-Build Contract." May 5, 2004.

Coxon, Patric. 2004. City of Bremerton Washington. Personal Communication. pcoxon@ci.bremerton.wa.us. 360-473-5448.

Crumb, Frank, P.E. 2004a. "Implementing Alternative Wet Weather Treatment Technology: Village Creek Wastewater Treatment Plant." Water Environment Federation Webcast - Blending: Regulatory Update. February 27, 2004.

Crumb, Frank. 2004b. Personal Communication. Frank.crumb@fortworthgov.org. 817-392-8243.

Fernbach, Edward. 2004. Camp, Dresser & McKee. Personal Communication. FernbackEJ@cdm.com.

Floyd, Steve. 2004. Superintendent of Wastewater, Fort Smith, Arkansas. Personal Communication. (479) 784-2231.

Gregus, Chris. 2004. St. Bernard Parish Water and Wastewater Division. Personal Communication. cgregus@sbgp.net, 504-271-1681.

Hegeman, Mark. 2004. Kansas River WWTP Manager, Lawrence, Kansas. Personal Communication. 785-832-7837.

Infilco Degrémont, Inc. 2002. "Densadeg High-Rate Clarifier and Thickener."

Infilco Degrémont, Inc. 2004a. "Densadeg 2D-100 FAQ - M&E Blue Plains.pdf."

- Infilco Degrémont, Inc. 2004b. "Representative Installations." <http://www.infilcodegremont.com/references.html>. Accessed May 12, 2004.
- Infilco Degrémont, Inc. 2004c. "Technical Papers." <http://www.infilcodegremont.com>. Accessed Dec 29, 2004.
- John Meunier, Inc. 2004. "Actiflo Brochure." Canada.
- Jolis, Domènec and Meei-Lih Ahmad. 2001. "Pilot Testing of High Rate Clarification Technology in San Francisco." WEFTEC 2001.
- Keller, John and Matthew Schultze. 2004. "Rain Yes, Foam No." *Water Environment & Technology*, Vol. 16, No. 3; pg. 31-35.
- Keller, J., Schultze, M, and Wagner, D. (2001). Lawrence, Kansas: Detailed Design Issues for a Ballasted Flocculation System. Presented at WEFTEC 2001
- Klamm, Jeanette. 2004. City of Lawrence, Kansas. Personal Communication. jkamm@ci.lawrence.ks.us, 785-832-7846.
- Krüger, Inc. 1998. "ACTIFLO Pilot Study for the Metropolitan Sewer District at the Mill Creek Wastewater Treatment Plant, Cincinnati, OH – Testing Period April 14, 1998 through April 29, 1998."
- Krüger, Inc. 1999. "ACTIFLO Pilot Study for the City of Tacoma Public Works Department at the Central Wastewater Treatment Plant, Tacoma, WA – Testing Period February 15, 1999 through March 5, 1999."
- Krüger, Inc. 2004. "ACTIFLO." <http://www.krugerusa.com>. Accessed Dec 29, 2004.
- Lavel, Patricia. 2004. Schreiber, Inc. Personal Communication. 205-655-7466.
- Leng, J., A. Strehlar, B. Bucher, J. Gellner, K. Kennedy, and J.B. Neethling. 2004. "No Small Feat: Compact Technologies Out Do Conventional Primary Treatment Processes." *WE&T*, January 2004.
- Lyon, Tom. 2004. Black & Veatch. Personal Communication. lyonta@bv.com. 419-720-0900.
- Middlebrough, Frank. 2004. Plant Manager, Bay View WWTP, Toledo, Ohio. Personal Communication. Frank.Middlebrough@ci.toledo.oh.us, 419-727-2602.
- Poppe, John, Edward J. Fernbach, and Song Ling Ng. 2001. "Treating Stormwater with a High-Rate Wet Weather Solution." *Public Works*, July 2001

Sampley, W. Eugene and William D. Sullivan. 2002. "No Longer Under the Water, Bremerton adopts an effective combined sewer overflow control solution." *Pollution Engineering*, May 2002.

Schreiber. Unknown date. "Fuzzy Filter High Rate Compressible Media Filtration System." Powerpoint Presentation pass along by Glenn Quinn of Ames Inc.

Schreiber Corporation. 2003. "Fuzzy Filter Compressible Media Filter." <http://www.schreiberwater.com/html/equipment/fuzzyfilter.html>. Accessed April 22, 2004.

Tarallo, S., M.W. Bowen, A.J. Riddick, and S. Sathyamoorthy. 2000. "High Rate Treatment of CSO/SSO Flows Using a High Density Solids Contact Clarifier/Thickener – Results from a Pilot Study." Kansas Water Environment Association 55th Annual Conference, April 18-20, 2000.

Thompson, Dan. 2004a. "Blending: An Essential Tool in Protecting Water Quality." Water Environment Federation Webcast - Blending: Regulatory Update. February 27, 2004.

Thompson, Dan. 2004b. Personal Communication. 253-591-5588.

Water Environment Research Foundation (WERF). 2002. "Peer Review: Wet Weather Demonstration Project in Columbus, Georgia."

Wm. H. Reilly & Company. 1998. "US Filter Krüger FLUENTlines, A Quarterly Report On Advanced Water And Wastewater Treatment Technologies From Krüger, Inc." September 1998, Vol. 3, No. 1. Available at: <http://www.whreilly.com/500mgd>.

WWETCO, LLC. 2001. "Wet Weather Demonstration Projects: CSO Technology Testing, Source Water Assessment and Protection, Watershed Assessment and Management, Draft Summary Report.

**District of Columbia Water and Sewer Authority
Blue Plains Total Nitrogen Removal /
Wet Weather Plan**

APPENDIX E

**Impact of Wet Weather Events on Plant
Operations of the Biological Nitrogen
Removal Process**

TECHNICAL MEMORANDUM

IMPACT OF WET WEATHER EVENTS ON PLANT OPERATIONS OF THE BIOLOGICAL NITROGEN REMOVAL PROCESS



PREPARED FOR: DC WATER AND SEWER AUTHORITY
April 2007

PREPARED BY EPMC1-A
METCALF & EDDY
PEER CONSULTANTS
DELON HAMPTON & ASSOCIATES

DCFA# 373-WSA

Technical Memorandum
Impact of Wet Weather Events on Plant Operations of the
Biological Nitrogen Removal Process

Table of Contents

Introduction	1
Background.....	1
Secondary Treatment Process	2
Nitrification/Denitrification Process.....	4
Blue Plains Current NPDES Permit Flows	7
Proposed Permit Flows.....	7
Projected Hourly Flows	8
Wet Weather Operations of Biological Processes	9
BioWin Model Simulation of a Severe Storm	10
Dynamic Simulation Results – TN discharges	15
Scenario 1: 4-hour Peaking Factor = 2.0	15
Scenario 2: 4-Hour Peaking Factor = 1.5.....	16
Conclusions	18

List of Figures

Figure 1. Process Flow Diagram for Liquid Treatment.....	1
Figure 2. Process Flow Diagram for Secondary and Nitrification/Denitrification Treatment Facilities	2
Figure 3. Secondary Treatment System Operating Modes.....	3
Figure 4. Nitrification/Denitrification System Operating Modes	5

List of Figures (continued)

Figure 5. Process Flow Diagram for Liquid Treatment at the AWTP at Blue Plains with a Four-Hour Peak Flow Rate to Secondary = 555 MGD	7
Figure 6. Projected Blue Plains Hourly Influent Flow for a 2-week period in May.....	9
Figure 7. Bio Win Model Configuration for Wet Weather Operations.....	11
Figure 8. Number of Nitrification/Denitrification Reactors by Mode Over Time	14
Figure 9. Nitrogen Discharged Via Outfalls 001 and 002 for Scenario 1	15
Figure 10. Nitrogen Discharged Via Outfalls 001 and 002 for Scenario 2	17

List of Tables

Table 1. Operation Modes for Process Modeling Simulations for the Wet Weather Flow Scenarios	13
--	----

Technical Memorandum

Impact of Wet Weather Events on Plant Operations of the Biological Nitrogen Removal Process

Introduction

The purpose of this memorandum is to provide representatives of the Environmental Protection Agency (EPA) and other stakeholders to DC WASA's strategic process engineering plan with additional detail regarding the impact of wet weather flows on the operation of the Advanced Wastewater Treatment Plant at Blue Plains (AWTP) and, in particular, the impact of these wet weather flows on nitrogen removal. This memorandum provides background information on the wastewater treatment process at Blue Plains, projected plant influent flows during wet weather events, a summary of dynamic computer model simulations of biological process operation that predict plant performance during wet weather, and conclusions.

Background

The Blue Plains AWTP is a 370-mgd facility that provides wastewater treatment for over 2 million people in Washington, DC and surrounding jurisdictions. Blue Plains receives combined sewer flows that originate in the District's combined sewer system. The plant liquid treatment processes consist of preliminary treatment (screening and grit removal), primary treatment, secondary treatment, nitrification, denitrification, effluent filtration, and disinfection. Chemical phosphorous removal is provided in the primary and secondary treatment processes. Biosolids handling processes include primary sludge screening and dewatering, gravity thickening of primary sludge, dissolved air flotation thickening of biological sludge, centrifuge dewatering, and lime stabilization. Figure 1 shows a diagram of the liquid process flow through the plant and Figure 2 shows a more detailed process flow diagram through the secondary and nitrification/denitrification processes. This memo focuses on the impact of wet weather events on the biological processes.

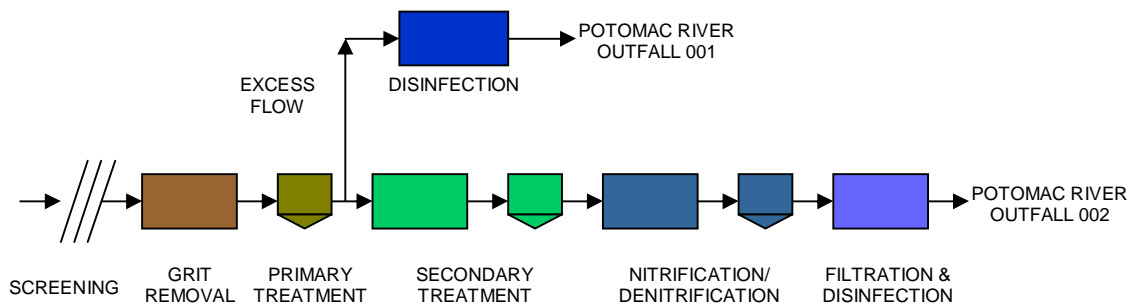

Figure 1. Process Flow Diagram for Liquid Treatment at the AWTP at Blue Plains

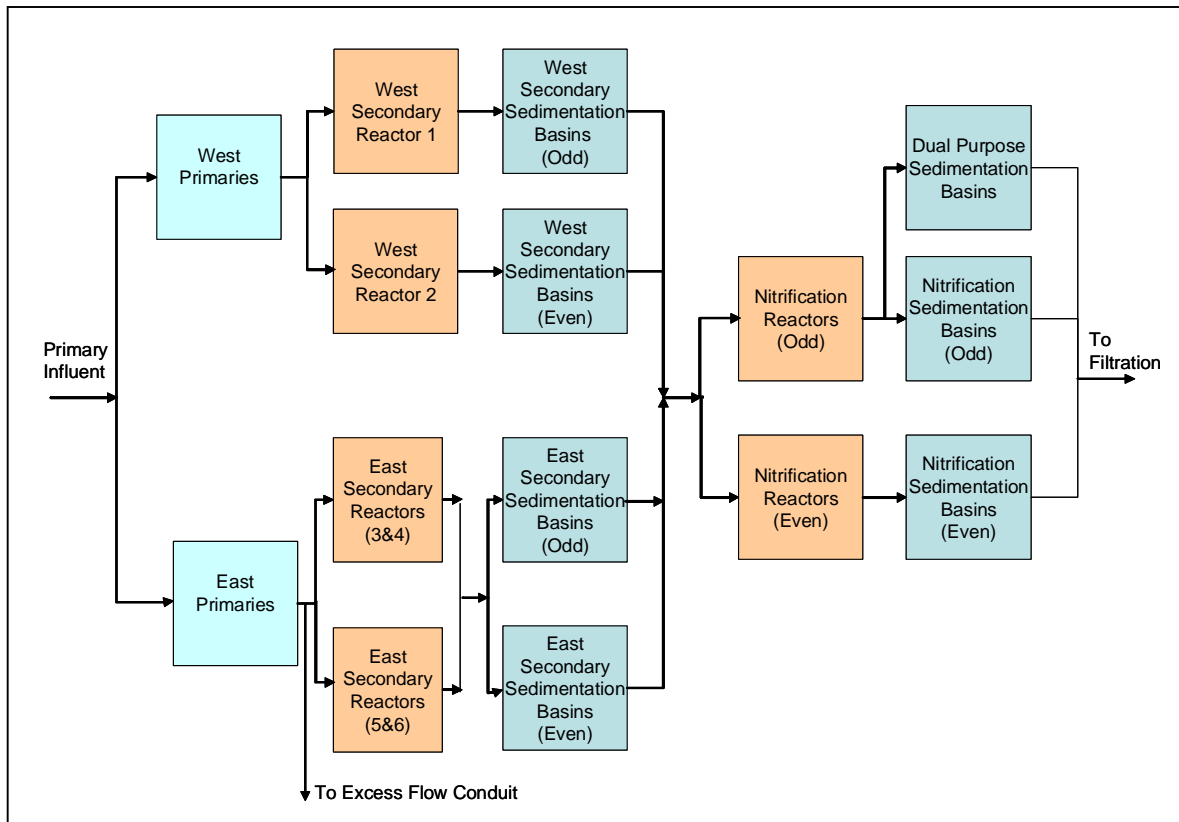

Figure 2. Process Flow Diagram for Secondary and Nitrification/Denitrification Treatment Facilities

Secondary Treatment Process

The secondary treatment process removes organic material that is measured as biochemical oxygen demand (BOD). The activated sludge process consists of reactors and sedimentation basins. The reactors receive primary effluent and return sludge (microorganisms) and are aerated to create an environment in which microorganisms that consume BOD can grow and thrive. The mixed liquor effluent from the reactors flows to secondary sedimentation basins. The microorganisms which make up the mixed liquor are settled in the sedimentation basins and are returned to the reactors. This is known as return activated sludge (RAS). A small portion of sludge is wasted from the return sludge to maintain the desired concentration of suspended solids in the reactors. The return sludge provides a continuous supply of microorganisms to the process to consume incoming organic material in the primary effluent.

As previously shown in Figure 2, the influent to Blue Plains is separated into two distinct flow streams, East Process and West Process, from preliminary through secondary treatment. Each process train consists of pumping, screening of the wastewater influent, grit removal, primary treatment and secondary treatment. The West Secondary Process consists of two four-pass reactors (Reactors 1 and

2) and twelve sedimentation basins, six basins dedicated to each reactor. The West Secondary Process receives 40% of the influent flow up to its limited peak flow rate of 296 mgd. The East Secondary Process consists of four four-pass reactors (Reactors 3, 4, 5 and 6) and twelve sedimentation basins. The East Secondary Process receives 60% of the influent flow up to a peak flow rate of 444 mgd.

The normal and wet weather flow distribution modes to the reactors are shown in Figure 3. The dry weather mode of operation is called plug-flow and the wet weather modes are called step feed.

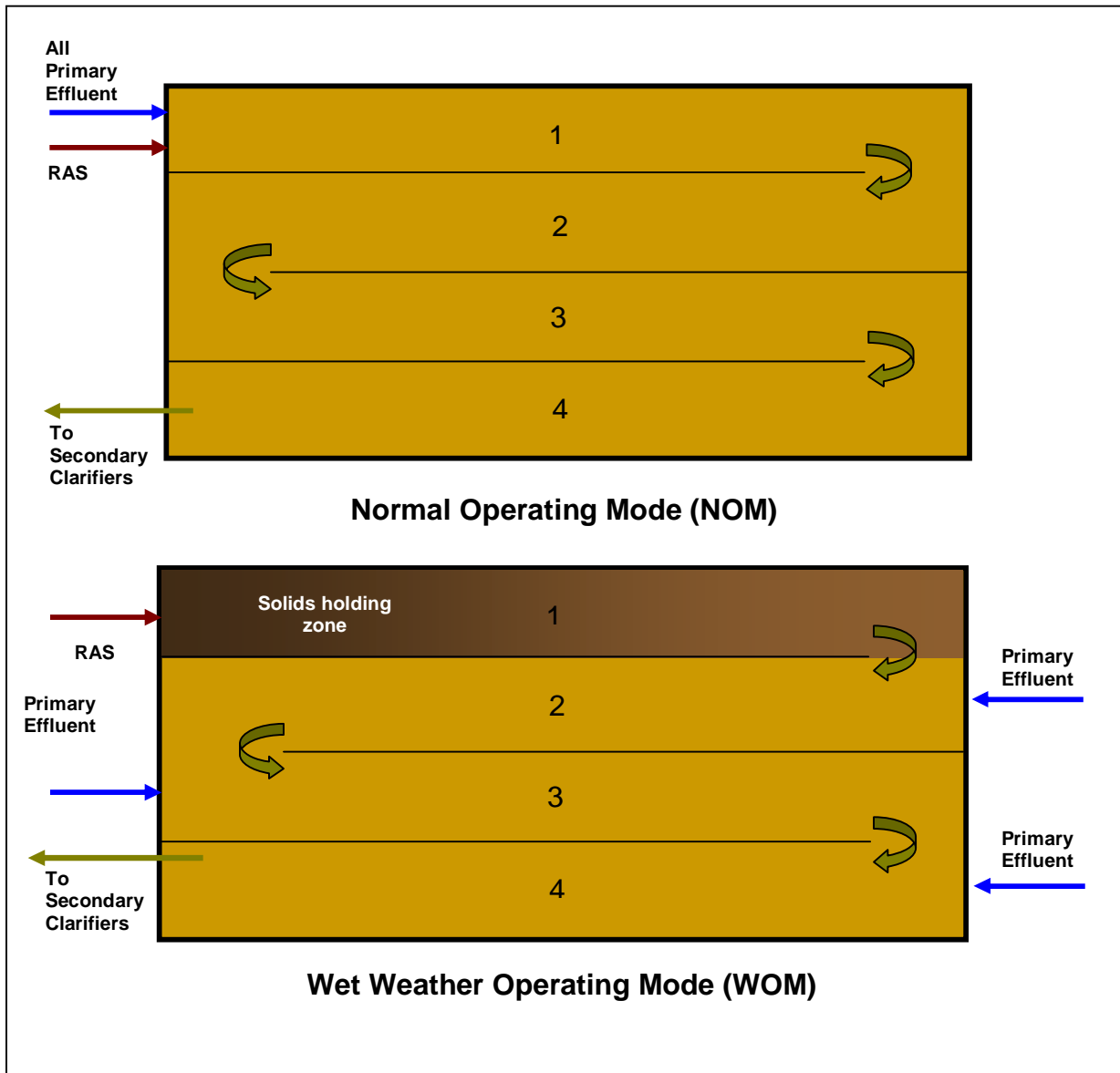

Figure 3. Secondary Treatment System Operating Modes

The plug-flow mode is the most efficient mode because it provides the greatest contact time between the organic material and the microorganisms. This preferred mode of operation provides the highest quality secondary effluent. The step feed modes are used by necessity in wet weather to store solids and minimize solids loadings on the sedimentation basins to reduce the occurrence of wash outs.

Nitrification/Denitrification Process

The purpose of the nitrification/denitrification process is to remove nitrogen from the wastewater. The suspended-growth activated sludge process consists of reactors and sedimentation basins. The reactors receive secondary effluent and use various microorganisms, which thrive in different environmental conditions, to process and remove nitrogen. Each nitrification/denitrification reactor consists of 5 consecutive stages to produce the proper environmental conditions for the microorganisms to do their work. Generally, the first three stages are aerobic and within the aerobic stages autotrophic microorganisms will convert ammonia ($\text{NH}_4\text{-N}$) to nitrate ($\text{NO}_3\text{-N}$). The last two stages are anoxic and within the anoxic stages heterotrophic microorganisms convert nitrate ($\text{NO}_3\text{-N}$) to nitrites ($\text{NO}_2\text{-N}$) and finally to nitrogen gas (N_2). The heterotrophic microorganisms require a supplemental carbon source. Methanol is the supplemental carbon source used in the denitrification process at Blue Plains. The mixed liquor effluent from the reactors flows to nitrification/denitrification sedimentation basins. The microorganisms which make up the mixed liquor are settled in the sedimentation basins and are returned to the reactors. Some sludge is wasted from the return sludge to maintain the desired concentration of suspended solids in the reactors. The return sludge provides a continuous supply of microorganisms to the process reactors to allow nitrification and denitrification to occur.

The Nitrification/denitrification process consists of twelve five-stage reactors and thirty-six sedimentation basins. Twenty-eight of the sedimentation basins are always part of the nitrification/denitrification process while the remaining eight basins are considered dual-purpose because they can be converted to be used as sedimentation basins for the secondary treatment processes as well, when needed.

The normal and wet weather flow distribution modes to the reactors are shown in Figure 4. The dry weather mode of operation is called plug-flow and the wet weather modes are called 'wet weather' and 'return only'. The plug-flow mode is the most efficient mode because it provides the greatest contact time between the nitrogen and the microorganisms. This preferred mode of operation provides the lowest concentration of nitrogen in the effluent. The wet-weather and return only modes are used by necessity in wet weather to store solids and minimize solids loadings on the sedimentation basins to reduce the occurrence of wash outs.

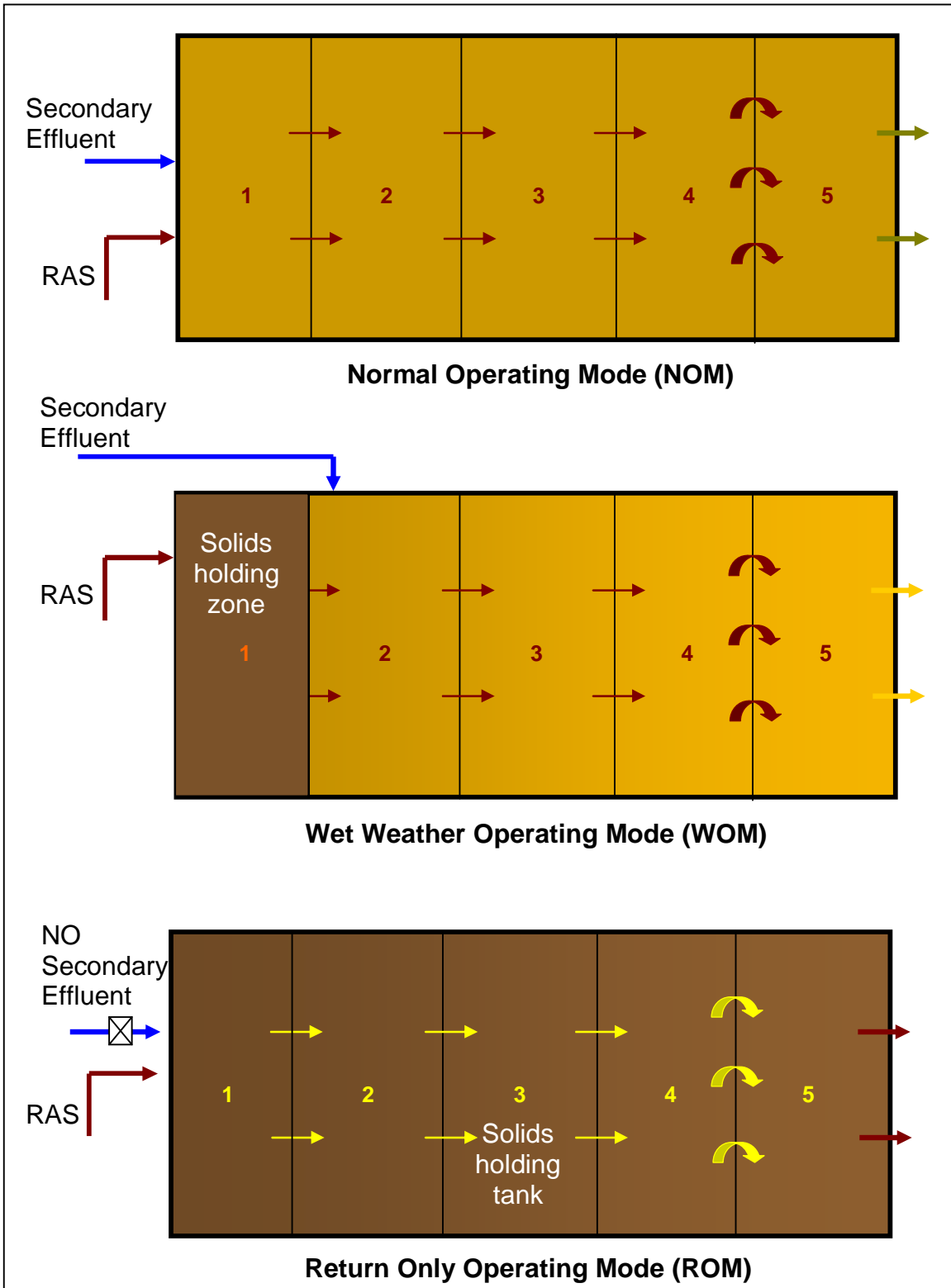

Figure 4. Nitrification/Denitrification System Operating Modes

Blue Plains Current NPDES Permit Flows

The NPDES permit for Blue Plains contains specific requirements for treatment of wet weather flows. The permit defines a wet weather event starting when the plant influent flow reaches 511 mgd. When that occurs, the plant is obligated to treat a flow up to 740 mgd for a 4 hour period through the complete treatment process. After four hours, the permit allows the plant to reduce the flow to the complete treatment processes to 511 mgd and hold the flow at that level as long as the influent wastewater flow arrives at the plant at a rate of 511 mgd. Influent wastewater flows above 740 mgd for the first 4 hours and above 511 mgd after the 4-hour period are treated as 'excess flow' and receive screening, grit removal, primary treatment, disinfection and dechlorination. The peak capacity of the excess flow treatment system is 336 mgd. Consequently, during the first 4 hours of the storm, the total plant influent capacity is 1,076 mgd (740 mgd to complete treatment and 336 to excess flow treatment) and after the 4-hour period the total plant influent capacity is 847 mgd (511 mgd to complete treatment and 336 to excess flow treatment). The peak factor for flows to complete treatment is 2.0 for up to 4 hours.

Proposed Permit Flows

To provide for increased nitrogen removal, WASA has proposed to reduce the peak flow to complete treatment to 555 mgd for the first 4 hours of the storm event. This reduces the peaking factor from 2.0 to 1.5. The proposal also includes providing a higher level of treatment to 'excess flow' through an enhanced clarification facility. Figure 5 shows the flow diagram for the proposed permit condition.

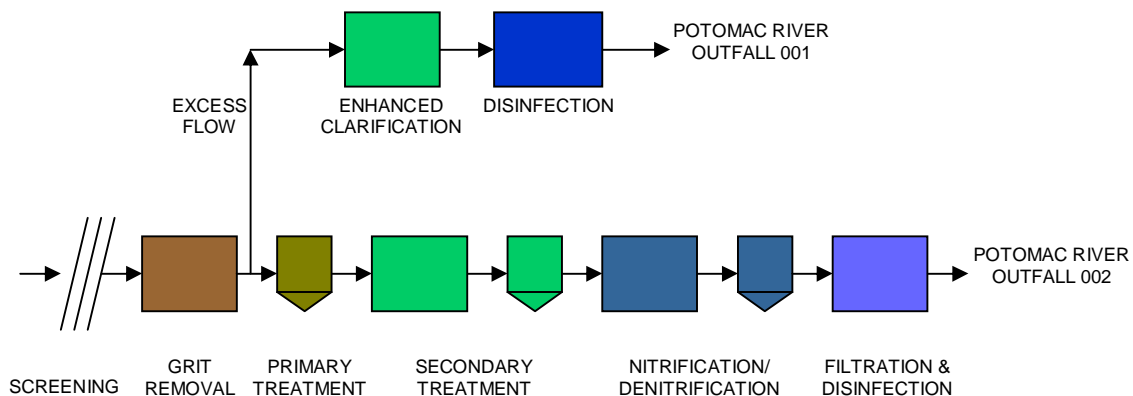

Figure 5. Process Flow Diagram for Liquid Treatment at the AWTP at Blue Plains with a Four Hour Peak Flow Rate to Secondary = 555 MGD

Projected Hourly Flows

The Blue Plains AWTP has a rated annual average flow capacity of 370 mgd. The average annual rated capacity accounts for variation in hourly flows due to diurnal fluctuations, variation in seasonal flows due to groundwater table fluctuations, and increases in influent flow due to storm inflow into the collection system. For a year with average precipitation, the plant's rated average daily flow is 370 mgd and the peak diurnal flow is approximately 415 mgd, only 12% higher than the average daily flow.

As part of DC WASA's Long Term Control Plan (LTCP), Greeley and Hansen Engineers developed a computer model to simulate flows in the collection system that will arrive at Blue Plains upon completion of the LTCP under a variety of hydrologic conditions. For purposes of the strategic process engineering plan, G&H used this computer model to predict hourly plant influent flow for a 3-year period (wet year, dry year and average year) for the 370 mgd rated capacity of the Blue Plains AWTP. This is defined as the average hydrologic year.

Figure 6 shows the projected Blue Plains hourly influent flow from the computer model for the first two weeks of May. A five day wet weather event was selected from the data set to be used in this analysis. It is noted that the flow during the last three days of the event is constant at 450 mgd. This reflects emptying the combined sewer system (CSS) storage tunnel system. The following section describes how the plant would operate under the wet weather conditions shown in Figure 6.

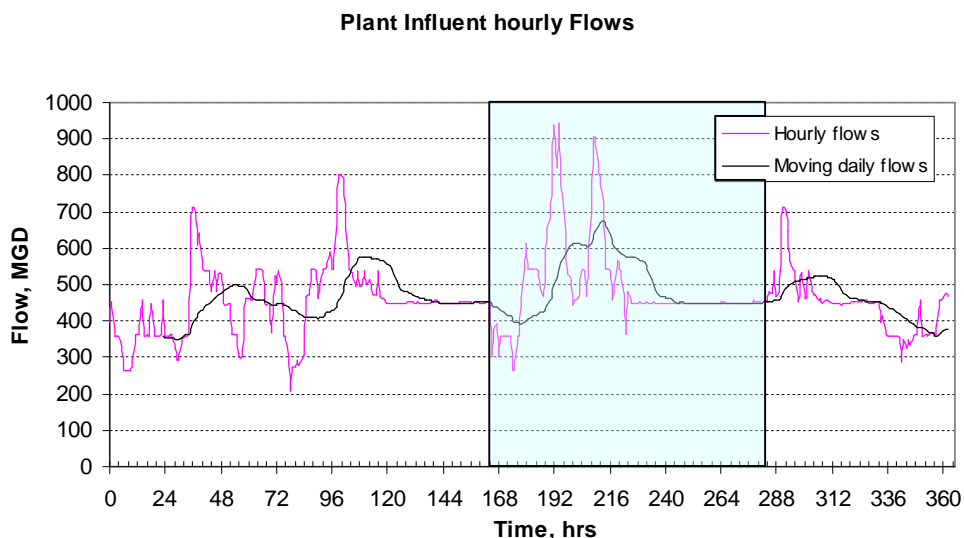

Figure 6. Projected Blue Plains Hourly Influent Flow for a 2-week period in May

Wet Weather Operations of Biological Processes

A wet weather event results in an increase in peak flow to the plant. Each day, the plant operators, supervisors and process engineers take measurements, assess the condition and performance of the plant and make changes to maintain the mixed liquor concentrations at the target levels in the secondary and nitrification/denitrification processes. If a wet weather event is predicted, even closer attention is paid to the treatment process by the operators. The biological process that occurs in the reactors cannot be adjusted in a matter of hours; rather it takes days to adjust the secondary process and weeks for the nitrification/denitrification process. For that reason, the mixed liquor, that is, the concentration of microorganisms in the reactors, is consistently targeted to a level that would be required to treat peak wet weather flows without process upsets, that is, washing solids out of the sedimentation basins. The capacity of the sedimentation basins to handle peak wet weather flows depends on the settling characteristics of the mixed liquor. Plant operations staff measure the rate at which the sludge settles on a daily basis. When a wet weather event is predicted, the number of reactors that are switched into various wet weather operational modes depends on how well the sludge is settling. The intent of the wet weather modes is to hold some solids (microorganisms) in the reactors to prevent overloading the sedimentation basins and washout of the microorganisms. For the secondary reactors, approximately 12 hours before the wet weather flow is to arrive at the plant, the wastewater influent gate to pass 1 is closed (Figure 3). For the nitrification/denitrification reactors, approximately 12 hours before the wet weather flow is to arrive at the plant, 6 reactors are placed in 'return only' operating mode and 6 reactors are placed in 'wet weather' operating mode. The operating modes for the nitrification/denitrification system are shown in Figure 4. Return only mode stores the microorganisms within the reactor because the return sludge flow continues to be fed to the reactor but the influent wastewater flow is not. Since no secondary effluent is fed to the reactor, the reactor is essentially off line and provides no nitrification or denitrification. In wet weather mode, the wastewater influent gate to stage 1 of the reactor is closed, return sludge continues to be fed to stage 1 and all of the secondary effluent is fed into stage 2 of the reactor. This will store the microorganisms in stage 1 while allowing stages 2 thru 5 to continue to process the wastewater flow. The overall treatment capacity of the reactor to nitrify and denitrify is reduced.

After the peak flow subsides, pairs of secondary reactors are put back into normal dry weather mode every 8 hours. The reason for putting the reactors back into normal mode slowly is to prevent overloading the sedimentation basins with the solids that were stored in the reactors during the wet weather event. The secondary treatment process can handle sustained high flows up to 450 mgd in normal operating mode.

In the nitrification/denitrification process, once the storm is over and sustained high flow is projected for more than a day, the 6 reactors that were in return only

mode are switched to wet weather mode. Two (2) reactors, (one odd and one even), can be switched from return only mode to wet weather mode over a 24 hour period. Once all the reactors are in wet weather mode and no storms are predicted for the day, pairs of reactors (one even, one odd) are switched from wet weather mode to normal mode every 8 hours. It is noted that it takes 3 days after the storm event to switch the 6 reactors in return only mode back into wet weather mode and another 2 days to return all 12 of the reactors to dry weather mode. The nitrification/denitrification process is impacted during this 5-day period after the storm event.

As shown on Figure 6 (beginning at approximately hour 226), there is a period of sustained high flow (approximately 450 mgd) after the storm has passed. This flow reflects the emptying of the combined sewer storage tunnel and discharge of the stored combined sewer flow to the sewer collection system after the storm. The projected time to empty the combined sewer tunnels, which is the period of sustained high flow, is 2 1/2 days.

BioWin Model Simulation of a Severe Storm

A wet weather operation (WWO) model was developed using the calibrated BioWin plant model to simulate the effect of the high plant influent flows during wet weather events, on the nitrification/denitrification process operation and performance. In order to simulate the plant operation during these events, the model was constructed with sufficient detail in the treatment processes to accurately reflect the plant operational response and predict the plant's treatment performance. Figure 7 shows the configuration of the plant that was used in the dynamic simulation of wet weather operations. The temperature used for modeling was selected to be 15 °C, which is the average temperature for May, the month during which the storm was predicted.

The WWO model was used to evaluate the nitrification/denitrification process performance and operation for two scenarios. Each scenario represents a different peak flow through the nitrification/denitrification process. Scenario 1 is peak flow through nitrification/denitrification process = 740 mgd. Scenario 2 is peak flow through nitrification/denitrification process = 555 mgd.

In each scenario, all dry weather flow (i.e., plant influent flow up to 511 mgd) receives treatment through the complete treatment process. For the first four hours after the plant influent flow exceeds an influent flow rate of 511 mgd, a peak flow rate is required to be treated through the complete treatment process. The ratio of the peak flow rate to the average annual rated capacity in mgd (i.e., 370 mgd) is called the peaking factor (PF). Plant influent flows above those that are provided complete treatment are called excess flow and will be treated in an Enhanced Clarification Facility and discharged to the river via Outfall 001. The enhanced clarification process is a physical-chemical process that is effective at removing particulate matter from the wastewater. The process is appropriate for

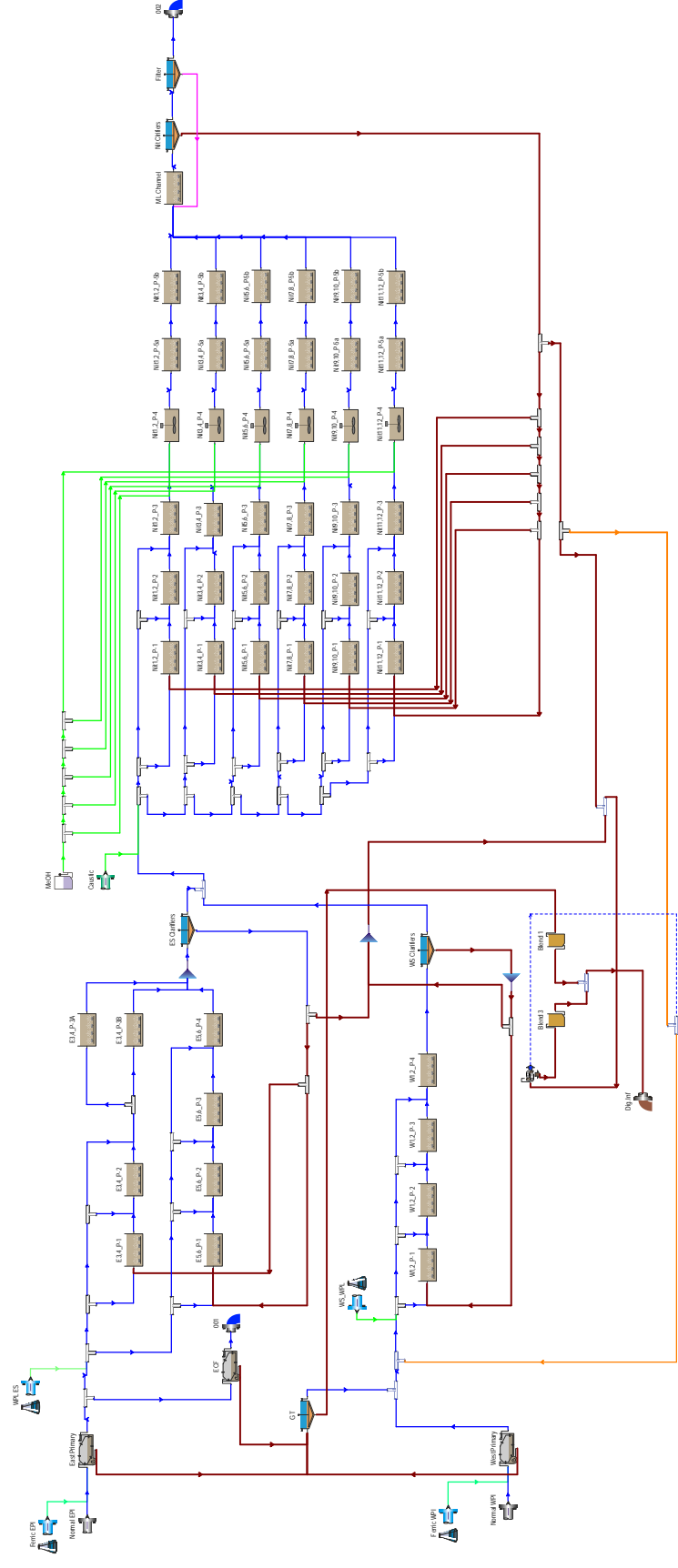

Figure 7. Bio Win Model Configuration for Wet Weather Operations

treatment of wet weather flows because it only takes approximately twenty minutes to initiate and there is no need to operate it during dry weather.

This modeling assumed a minimum combined sewer storage tunnel dewatering time of 59 hours. A shorter tunnel dewatering time would result in a reduction in the number of days that the biological systems remain in wet weather model.

The operational modes preceding a wet weather event and the operational modes employed after a wet weather event are also important to consider. The operations can be classified into 3 phases:

- Phase 1) Dry/normal weather phase
- Phase 2) Wet Weather phase
- Phase 3) Recovery phase

Table 1 presents the operational modes associated with each phase for the secondary reactors as well as for the nitrification/denitrification reactors for each scenario. Figure 8 shows the switching of the 12 nitrification/ denitrification reactors over time from Phase 1 through Phase 3.

Phase 1 is the basic operation scheme of treatment processes during normal dry weather flows. The wet weather operations model began with 1 day of normal flow (i.e., 370 mgd).

Phase 2 comprises the wet weather event during which reactors are switched into wet weather mode to hold solids in the reactors so that the sedimentation basins do not become overloaded and wash-out. The 5-day wet weather period selected for modeling is highlighted on Figure 6 and includes instances of peak flows for plant influent as well as a few days of sustained plant influent at a rate of 450 mgd.

Phase 3, the recovery phase, begins when the wet weather event has ended and the combined sewer storage tunnel has been pumped-out. The recovery phase entails a process to switch the modes from wet weather operations to dry weather, or normal operations. For purposes of modeling, normal flow (i.e., 370 mgd) was assumed for the 4 days that the recovery period lasted in the wet weather operations model.

**Table 1. Operation Modes for Process Modeling Simulations
for the Wet Weather Flow Scenarios**

Phase 1: Dry Weather Phase		Phase 2: Wet Weather Phase		Phase 3: Recovery Phase	
Scenario 1 PF = 2.0	Scenario 2 PF = 1.5	Scenario 1 PF = 2.0	Scenario 2 PF = 1.5	Scenario 1 PF = 2.0	Scenario 2 PF = 1.5
NOM – EPE to stage1, RAS to stage1	NOM – EPE to stage1, RAS to stage1	WOM – EPE to stages 3a & 3b, RAS to stage1	WOM – EPE to stages 3a & 3b, RAS to stage1	Back to NOM	Back to NOM
NOM – EPE to stage1, RAS to stage1	NOM – EPE to stage1, RAS to stage1	WOM – EPE to stage2, RAS to stage1	WOM – EPE to stage2, RAS to stage1	Back to NOM	Back to NOM
NOM – WPE is step-fed to stages 1 through 4, RAS to stage1	NOM – WPE is step-fed to stages1 through4, RAS to stage1	WOM – WPE is step-fed to stages 3 & 4, RAS to stage1	WOM – WPE is step-fed to stages 3 & 4, RAS to stage1	Back to NOM	Back to NOM
NOM – SE to stage1, RAS to stage1	NOM – SE to stage1, RAS to stage1	6 reactors in ROM – No SE, RAS to stage1 & 6 reactors in WOM – SE to stage2, RAS to stage1	All reactors in WOM – SE to stage2, RAS to stage1	6_**ROM** reactors back to WOM – 2 reactors every 24 hrs Then 12_**WOM** reactors back to NOM – 2 reactors every 8 hrs after sustained flows are over	12_**WOM** reactors back to NOM – 2 reactors every 8 hrs after sustained flows are over

Scenario 1: PF = 2.0
Nit./Denit. Reactors Operating Chart

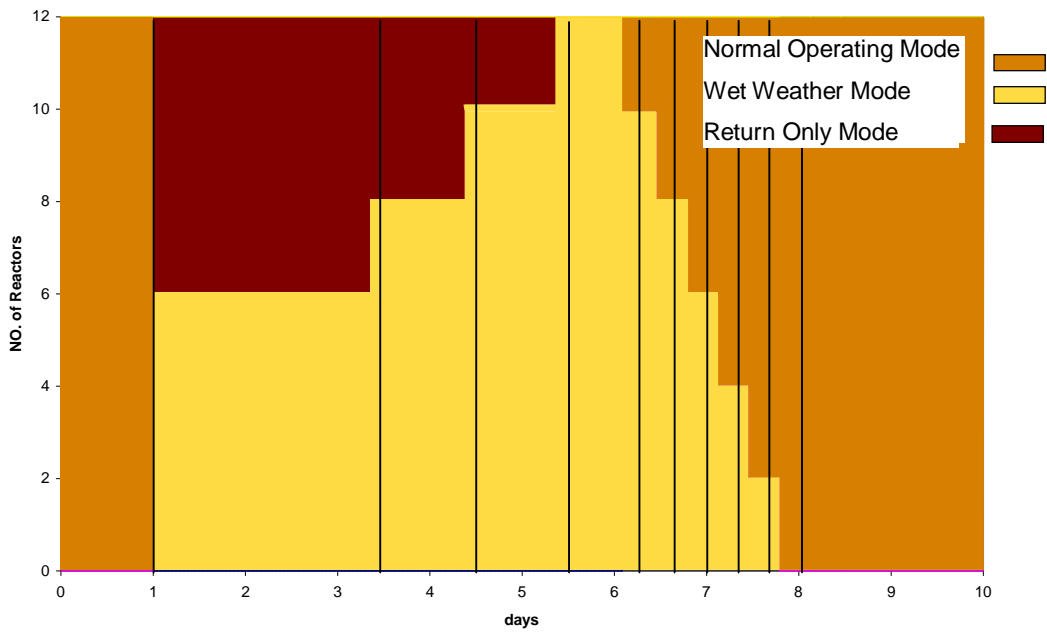

Scenario 2: PF = 1.5
Nit./Denit. Reactors Operating Chart

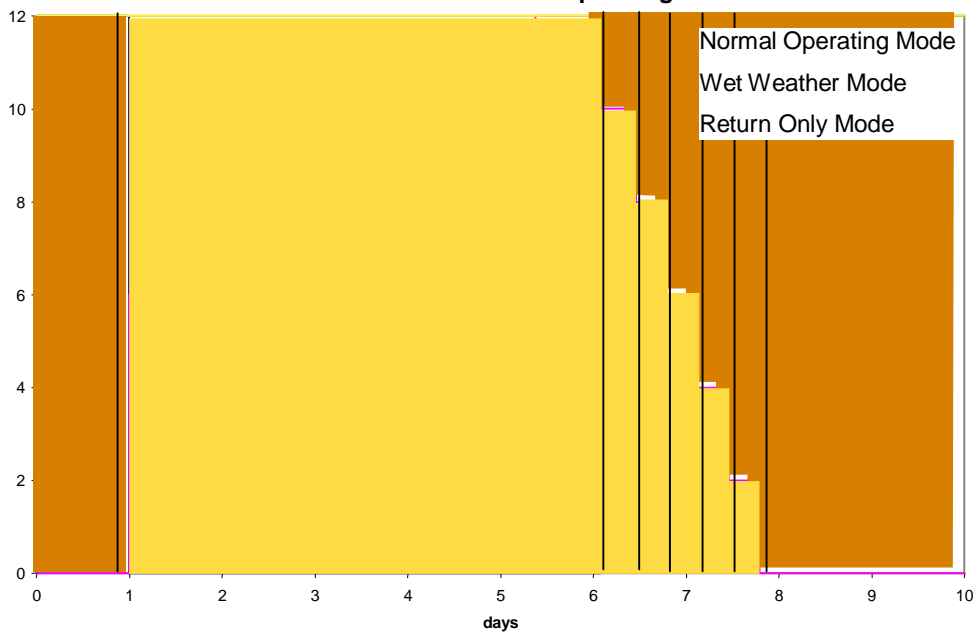

Figure 8. Number of Nitrification/Denitrification Reactors by Mode Over Time

Dynamic Simulation Results – TN discharges

Scenario 1: 4-hour Peaking Factor = 2.0

Figure 9 shows the results of the modeling run for TN discharge loads through Outfall 002 and Outfall 001 during the simulation period. The time increments are 4 hours and the load is shown in the rate of pounds per day (lb/d). In the initial normal mode, when the plant operates at 370 MGD, the discharge TN loading out of Outfall 002 was approximately 11,600 lbs/d. During the wet weather event, the discharge through Outfall 002 significantly increased due to limiting the process nitrification capacity as a result of switching some of the nitrification/denitrification reactors and stages into solids holding tanks. The plant performance was slowly improving as reactors were switched back from return only to wet weather operation and eventually to normal operation. The peak nitrogen load shown corresponds to a maximum concentration of approximately 10 mg N/L effluent total nitrogen concentration from the nitrification/denitrification system. A total of 263,000 lbs of TN were discharged to the river from Outfalls 001 and 002 over the simulated period (10 days). The impact of the wet weather operation on process performance is indicated by the TN values shown in Figure 9.

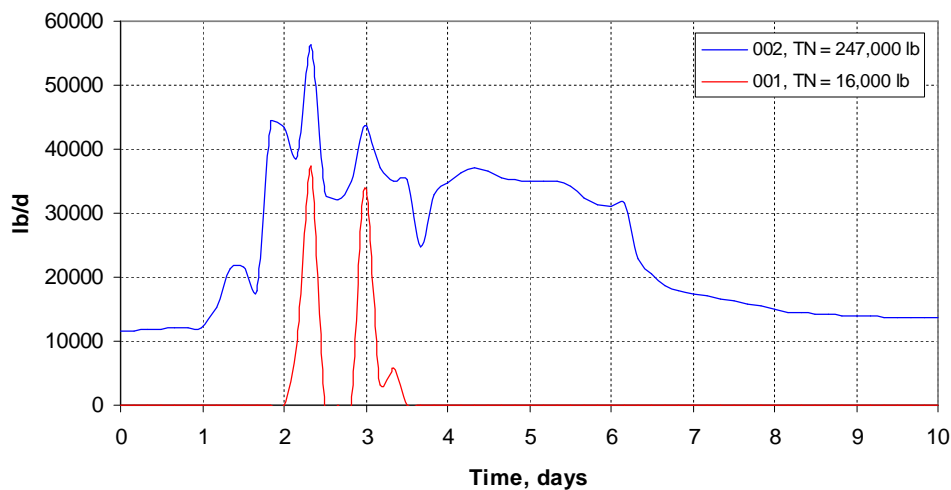

Figure 9. Nitrogen Discharged Via Outfalls 001 and 002 for Scenario 1

The total pounds of TN discharged through Outfall 001 during the wet weather event were approximately 16,000 pounds. The total pounds of TN discharged through Outfall 002 during the 10 days of simulation were approximately 247,000 pounds. If wet weather had not occurred during the simulation period, the discharge would have been 116,000 pounds of total nitrogen via Outfall 002. This translates to an estimated additional 131,000 pounds of TN discharge to the river via Outfall 002 due to the wet weather event.

As expected, total nitrogen load increases as the flow through the system increases. The treated excess flow during the storms on days two and three on Figure 9 result in a nitrogen load to the river from Outfall 001 during the wet weather event and the loads are directly proportional to flow discharged.

On the other hand, the variation in total nitrogen discharge from Outfall 002 is related to cascading effects of the wet weather event. Prior to the storm, the nitrogen concentration from the nitrification/denitrification system increases because reactors are switched to wet-weather and return-only modes. The result of using these modes to store solids during a wet weather event is that the reactor volume treating secondary effluent to remove nitrogen is reduced. Once the wet weather peak reaches the nitrification/denitrification system (day two on Figure 9), the nitrogen load increases due to a combination of higher flow and higher concentration. Following the storm, the total nitrogen load discharged through Outfall 002 decreases but remains at higher than normal loads due to the sustained high plant influent flow from the combined sewer storage tunnel pump-out. Figure 9 shows the case of a 59 hour dewatering time but some proposed alternatives dewater the combined sewer storage tunnels in 6 hours. During the recovery phase (days 8 to 10 on Figure 9), the total nitrogen discharge concentration returns to normal levels as the reactors are slowly switched back into normal operating modes. Consequently, as the flow and concentration return to normal levels, the total nitrogen loading to the river also returns to dry weather values.

Scenario 2: 4-Hour Peaking Factor = 1.5

Figure 10 shows the effect of reducing the 4-hour peaking factor from 2.0 to 1.5 (i.e. 740 mgd to 555 mgd) on TN discharge loads through Outfalls 001 and 002 to the river. As shown on the figure, the TN load through Outfall 002 for the simulation period was reduced to a total of 195,000 lbs. The reduction of the peak flow through the nitrification/denitrification process enables the plant operation to maintain more process reactor capacity on-line and treating secondary effluent to remove nitrogen during wet weather. This additional capacity is used to remove nitrogen resulting in decreased total nitrogen discharge through Outfall 002. The maximum effluent total nitrogen concentration from the nitrification/denitrification system dropped from approximately 10 mg/l to approximately 7.5 mg N/L. Despite the fact that TN load through Outfall 001 has increased to 19,000 lbs, as compared to 16,000 lbs for scenario 1, the total TN to the river through Outfalls 001 and 002 would be approximately 49,000 lbs less than scenario 1. The positive effect of reducing the 4-hour peaking factor from 2.0 to 1.5 on process performance is observed in the TN values.

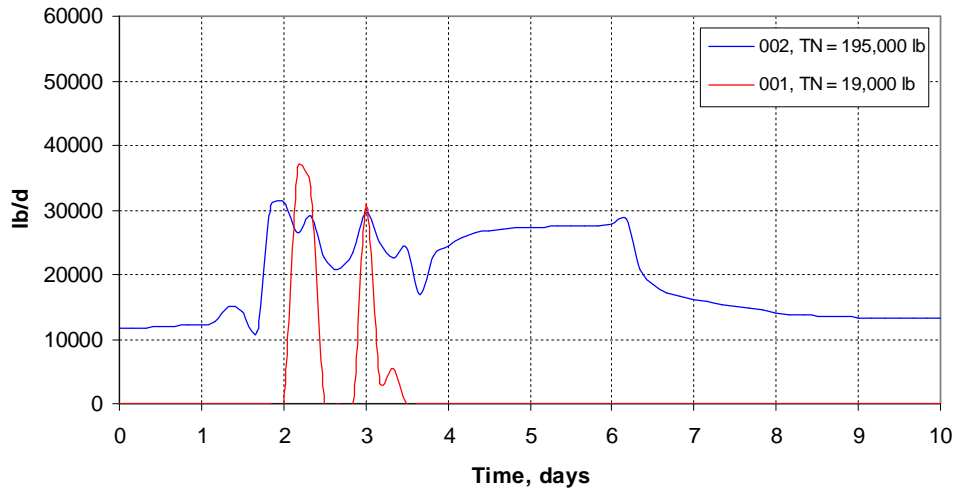

Figure 10. Nitrogen Discharged Via Outfalls 001 and 002 for Scenario 2

The patterns of nitrogen loading in scenarios 1 and 2 are similar. That is, the nitrogen discharge through Outfall 001 increases in direct proportion to excess flow during the peak wet weather while the nitrogen discharge through Outfall 002 varies through the wet weather and recovery phases. Scenario 2 yields a greater total nitrogen load to the river through Outfall 001 than Scenario 1 due to the increased excess flow volume.

On the other hand, the total nitrogen discharge from Outfall 002 for Scenario 2 is less than the total discharge from Outfall 002 for Scenario 1 because the nitrification/denitrification system is more stable due to the reduction in peak flow through the system. Prior to the storm, the nitrogen concentration from the nitrification/denitrification system increases because reactors are switched to wet-weather modes. The lower peak flow (555 mgd) through the nitrification/denitrification system enables the system to handle wet weather by switching reactors into wet weather mode whereas the higher peak flow (740 mgd) dictates that half the reactors be in return only mode. As described previously in this document (illustrated in Figure 4), the return only mode is used to hold solids to prevent overloading the sedimentation basins, which, while protecting the overall process, reduces the process reactor capacity treating secondary effluent., resulting in reduced nitrogen removal capacity. During the storm, when the wet weather peak reaches the nitrification/denitrification system, the nitrogen load through Outfall 002 increases due to a combination of higher flow and higher nitrogen concentration. However, the difference between Scenario 1 and Scenario 2 (Figures 9 and 10) is that both the peak flow and the peak concentration are less for the reduced peak flow and therefore the peak nitrogen load is significantly less. Following the storm, the process reactors remain in wet weather operation to handle the sustained high flow to Blue Plains from pump-out of the combined sewer storage tunnel. During this period, the total nitrogen load discharged through Outfall 002 is directly proportional to the

flow. During the recovery phase (days 8 to 10 on Figure 10), the total nitrogen discharge concentration returns to normal levels as the reactors are slowly switched back into normal operating modes. Consequently, as the flow and concentration return to normal levels, the total nitrogen loading to the river also returns to dry weather values.

Conclusions

The results of the dynamic modeling simulation of a wet weather event illustrates the impact that operational changes implemented during wet weather events have on nitrogen removal performance. Total nitrogen discharge to the Potomac River is predicted to be greater if the 4-hour peak flow through the wastewater treatment plant is 740 mgd than if the 4-hour peak flow through complete treatment is 555 mgd. The simulation was performed to illustrate the challenges that wet weather presents to the operation of the nitrification/denitrification system at Blue Plains. These numbers are specific to the wet weather event simulated and should not be extrapolated over time or to other events.

The following conclusions can be drawn from the modeling results:

- Wet weather flows negatively impact the plant performance regarding TN removal due to limiting the capacity of nitrification in the Nitrification/Denitrification Process. The limitation resulted from switching some of the stages and tanks in the process to solids holding zones. In addition, switching back the reactors to normal operation, i.e. recovery period, is directly related to the magnitude and duration of the plant influent flows through complete treatment. In other words, increasing these flows and their duration will result in longer period of recovery and hence degradation of performance.
- Reducing the plant influent 4-hour peaking flow from 740 MGD (PF=2.0) to 555 MGD (PF=1.5) provided for more on-line process reactor capacity during wet weather, a more stable operation, and a quicker recovery period, which resulted in significant reduction in the total TN load to the river.

**District of Columbia Water and Sewer Authority
Blue Plains Total Nitrogen Removal /
Wet Weather Plan**

APPENDIX F

Responses to Comments

Appendix F Responses to Comments

1. INTRODUCTION

This Appendix presents a summary of the public participation program conducted to solicit comments on the Draft TN/WW Plan and responds to comments received.

2. PUBLIC PARTICIPATION PROGRAM

2.1 Public Information Program

The public participation program consisted of the following elements:

- Washington Post Legal Notice
A legal notice was placed in the Washington Post on July 1, 2007, as shown on Figure F-1. The notice described the purpose of the TN/WW Plan, the logistics of the public meeting, and indicated where additional information could be obtained and the method and deadline for submitting comments.

Figure F-1
Washington Post Legal Notice



NOTICE OF PUBLIC MEETING

The District of Columbia Water and Sewer Authority (WASA) invites you to attend a public meeting regarding the proposed \$800 million Total Nitrogen Removal/Wet Weather Plan (TN/WW Plan) for the Blue Plains Wastewater Treatment Plant and the Combined Sewer System for the District. Details of the meeting are as follows:

Date and Time: Thursday, August 2, 2007 6:00 to 9:00 p.m.

Location: Metropolitan Washington Council of Governments, 777 North Capitol St., N.E., Washington, D.C. 20002 in the Training Room on the ground floor.

Purpose: Present WASA's proposed Total Nitrogen Removal/Wet Weather Plan and obtain public comments.

Background: WASA operates the wastewater collection system for the District of Columbia and provides wastewater treatment at the Blue Plains Wastewater Treatment Plant for the District and portions of Maryland and Virginia. In order to improve the quality of the Potomac River and the Chesapeake Bay, WASA is proposing a plan for removing nitrogen while accommodating wet weather flows from the Blue Plains service area. The plan involves improving the treatment process at Blue Plains, and modifying the District's Long Term Control Plan (LTCP) for controlling combined sewer overflows in the District. The modifications to the LTCP will improve the effectiveness of the nitrogen removal and combined sewer overflow control programs, while improving the water quality in the receiving waters. WASA has a consent decree which provides for implementation of the LTCP and modification of this decree is required to move forward with the proposed TN/WW Plan.

Written Comments: Written or e-mail comments will be received until September 17, 2007 at the following address: Ronald E. Bizzari, D.C. Water and Sewer Authority, 5000 Overlook Avenue, SW, Washington, DC, 20032, Tel. 202-787-2014, email: rbizzari@dcwasa.com.

A copy of the Draft TN/WW Plan and other information is available at WASA's web site at www.dcwasa.com and will be available at the following public libraries after July 9, 2007:

Capitol View-5001 Central Ave. SE	Southeast-403 7th St. SE
Mount Pleasant-3160 16th St. NW	Shepherd Park-7420 Georgia Ave. NW
Northeast-330 7th St. NE	Tenley-Friendship (interim location)-4200
Washington Highlands-115 Atlantic St., SE	Wisconsin Ave. NW
Martin Luther King, Jr. at Washingtonian	Woodridge - 18th & Rhode Island Ave., NE
Room - 901 G St. NW	

Responses to Comments

- Public Information Depositories
Public information depositories were maintained at ten public libraries in the District. The libraries included a document titled: *Public Information Document for Draft Blue Plains Total Nitrogen Removal / Wet Weather Plan and Anacostia River Projects Tunnels System Alignment*, June 2007. This document included the following sections:
 - Introduction
 - Draft Blue Plains Total Nitrogen Removal / Wet Weather Plan
 - Anacostia River Projects Tunnels System Alignment Information Document
 - WASA’s Modified NPDES Permit, issued April 5, 2007
 - Control Plan Highlights, which is a summary of the Long Term Control Plan, Final Report, July 2002
 - LTCP Consent Decree, entered by the Court on March 23, 2005

The document described the Draft TN/WW Plan and WASA’s working alignment for the Anacostia River Projects Tunnels System.

- Web site
The Draft TN/WW Plan and the Summary and Findings section of the report were available at WASA’s web site.
- Other Meetings
A briefing on the Draft TN/WW Plan was held on May 4, 2007 for government agencies, environmental groups and other interested parties. Attendees are shown on Table F-1.

Table F-1
Attendance at May 4, 2007 Informational Meeting

<i>No.</i>	<i>Affiliation</i>	<i>Name</i>
1	Anacostia Riverkeeper	Brian VanWye
2	Chesapeake Bay Foundation	Amy McDonnell
3	Chesapeake Bay Foundation	Beth McGee
4	Chesapeake Bay Commission	Suzan Bulbalkaya
5	D.C. Dept of the Environment	Hamid Karimi
6	D.C. Environmental Network, Friends of the Earth	Chris Weiss
7	D.C. Water and Sewer Authority	John Dunn
8	D.C. Water and Sewer Authority	Gordon Fry
9	D.C. Water and Sewer Authority	Jerry Johnson
10	D.C. Water and Sewer Authority	Sudhir Murthy
11	D.C. Water and Sewer Authority	Avis Russell
12	D.C. Water and Sewer Authority	Mohsin Siddique
13	Earth Justice	David Baron
14	Earth Justice	Jennifer C. Chavez
15	Fairfax County	Shahram Mohsenin
16	Greeley and Hansen	John Cassidy
17	Hatch Mott Macdonald	Larry Williamson
18	Maryland Dept. of the Environment	Virginia Kearney
19	Maryland Dept. of the Environment	M. Lelev
20	Metcalf & Eddy	Kathleen Kharkar
21	Metcalf & Eddy	Ed Locke
22	Metropolitan Washington Council of Governments	Gary Dickerman
23	Metropolitan Washington Council of Governments	Ted Graham
24	Metropolitan Washington Council of Governments	Tanya Spano

Responses to Comments

<i>No.</i>	<i>Affiliation</i>	<i>Name</i>
25	Potomac Riverkeeper	Ed Merrifield
26	Sierra Club	Irv Sheffey
27	Washington Suburban Sanitary Commission	Craig Fricke
28	Washington Suburban Sanitary Commission	J. L. Hearn
29	U.S. Dept. of Justice	Nancy Flickinger
30	U.S. Environmental Protection Agency	Jon Capacasa
31	U.S. Environmental Protection Agency	David McGuigan

2.2 Public Meeting

A public meeting was held on August 2, 2007 to present the plan and to obtain comments. Attendees are shown on Table F-2.

**Table F-2
Attendance at August 2, 2007 Public Meeting**

<i>No.</i>	<i>Affiliation</i>	<i>Name</i>
1	D.C. Dept. of Transportation	Bart Clark
2	D.C. Water and Sewer Authority	Aleizha Batson
3	D.C. Water and Sewer Authority	John Dunn
4	D.C. Water and Sewer Authority	Gregory Hope
5	Fru-con Construction	Rob Randolph
6	Greeley and Hansen	John Cassidy
7	Hatch Mott Macdonald	Larry Williamson
8	Private citizen	Bill Letzkus
9	U.S. Environmental Protection Agency	Mary Letzkus
10	Waste Water Management	Adam Nichols
11	Waste Water Management	Nick Valcourt
12	Whitman Requardt & Assoc.	Louis Klinefelter

3. COMMENTS AND RESPONSES

The comment period was open until September 17, 2007. Comments were received from the U.S. Environmental Protection Agency (EPA) only. Responses to EPA's comments are provided below:

1. The TN/WW Plan should include supporting information and detail in the schedule, in particular a Gantt chart, with an accompanying narrative would be useful to describe the different aspects of each portion of the project, e.g., procurement, design, access, etc. On page S-13, the TN/WW Plan schedule should also contain a compilation of total nitrogen construction milestones.

Response: A bar chart and descriptive information has been added to Section 5 of the final plan.

2. The TN/WW Plan should include a separate written justification for the CSO bypass through Outfall 001; this justification should address the requirements of the CSO Policy at II.C.7. It can be attached as an appendix and include or reference statements and data in the body of the plan. A short narrative would be preferred.

Response: In Section 5.5 of the Final Plan, WASA recommends permitting Outfall 001 as a CSO instead of a CSO bypass.

3. Page S – 1, last paragraph states: “When the LTCP was finalized in 2002, there was no effluent limit for total nitrogen in WASA’s NPDES permit for Blue Plains and the LTCP provided the imposition of total nitrogen limit could require a modification of the LTCP and its implementation schedule.” This statement is no longer accurate. Please delete. While the first part of the sentence is true, it is

Responses to Comments

also true that WASA had a very good idea of the potential costs of the ENR facilities, and in its discovery responses it provided that information to the United States, which then factored in the costs of ENR in order to justify the 20-year schedule. Accordingly, the costs involved in the Plan are already factored in.

Response: The cost of TN removal is not included in the LTCP, and the financial impact of TN removal has not been factored in to the cost of the LTCP or its schedule. To the contrary, WASA and the government have recognized that TN removal is not included in the LTCP and that imposition of a TN limit may require modification of the LTCP, extension of the LTCP schedule, or both. The 20-year schedule for the LTCP was based upon the financial impact of the CSO controls, the magnitude of the project, constructability factors and other considerations.

There are numerous references in the record documenting this position. These include, but are not limited to, the following:

- LTCP – the LTCP clearly indicates that the cost of nitrogen removal is not included in the plan, that the financial projections do not include nitrogen removal, and that the level of nitrogen removal and the projects required have not been established. See pages ES-11, 12-17, and 13-11. Further, the LTCP identifies that one of the bases for the development of the CSO control plan is the NPDES permit which existed at the time the plan was prepared. That plan included a nitrogen removal goal of 7.5 mg/L, not a permit limit (see page 13-34).
- LTCP Consent Decree – Appendix B of the LTCP Decree contains the financial projections upon which the 20-year LTCP schedule is based. The financial projections do not include nitrogen removal. Section VII of the Decree indicates that the 20-year schedule is based, in part, upon the financial projections included in Appendix B of the Decree. Further, the Decree indicates that the schedule and/or the selected CSO controls may be modified based on significant change in the financial information and other factors.
- Settlement communications – an October 23, 2003 settlement letter from David Evans of McGuire Woods to Nancy Flickinger of the Department of Justice transmitted financial projections to the Government. The financial projections evaluated the impact of a range of LTCP implementation schedules, a range of LTCP costs and the impact of potential future regulatory requirements such as TN. The financial projection that was adopted as the basis for the LTCP schedule is the one included in the LTCP Decree. This is the projection for the 20-year LTCP, without nitrogen removal or other future regulatory requirements. If nitrogen removal or other unknown regulatory requirements were factored in to the projections for the LTCP, then that financial information would have been included in the LTCP Decree and its basis would have been documented. This did not occur.

Accordingly, the language included in the Draft TN/WW plan is correct.

4. Page S – 5, states: “When the additional storage is provided by the tunnel extension, the peak flow rate conveyed into Blue Plains can be reduced to less than 1076 mgd.” And again, page 4 – 1 states that delivery of flow up to 1076 mgd will be conveyed to Blue Plains. If WASA believes that 1076 will be conveyed to Blue Plains for treatment when Alternative D is selected, please provide the basis for that position for both statements. Please reconcile the apparent inconsistency between these two statements.

Response: Page S-5 identifies that the peak flow rate to be treated by Blue Plains under alternative D will be less than 1076 mgd due to the additional storage provided. Page 4-1 indicates that up to 1076 mgd will be delivered by the collection system. Under Alternative D, part of this flow will be conveyed to storage, with the remainder receiving treatment per the flow limits identified in the plan. These statements have been clarified in the final plan.

Responses to Comments

5. Page S – 12, state: “Other changes as required to make permit/consent decree consistent with the TN/WW Plan.” Please identify any other changes and delete these overly broad phrases.

Schedule: WASA needs to state that it will place the operation of the ENR facilities in place on or before July 1, 2014, or six years from EPA approval of the plan, whichever is later. In addition, because we have agreed to a fixed date, delete the reference to eleven years after EPA approval of the TN/WW Plan, since other CSO deadlines are involved.

Response: In order to identify all of the changes that might be required in the permit and consent decree, it would be necessary for WASA, the Government and the District to perform a line by line review. This has not been performed yet and the statement in the report is to document that there may be other changes that the parties have not identified yet.

Regarding the schedule, the plan has been revised to indicate that ENR facilities will be placed in operation by July 1, 2014 or 6 years and 6 months after EPA approval of the TN/WW Plan. This date and the associated time frame are based on receiving EPA approval of the plan by Jan 1, 2008.

For the wet weather facilities (Blue Plains Tunnel, Enhanced Clarification Facility and Tunnel Dewatering Pumping Station), the plan has been revised to indicate these will be placed in operation by March 23, 2018 or 10 years and 3 months after approval of the TN/WW Plan. Again, the date and the associated time frame are based on receiving EPA approval of the plan by Jan 1, 2008.

6. Page 1 – 9. Plaintiffs approved the plan for the outfall repair in April of 2007. WASA should update the table to reflect calendar dates.

Response: This has been revised in the final document.

7. Page 2 – 29, states: “However, the LTCP was developed and finalized in July 2002, before the state Tributary Strategies, prepared in 2004, identified the need to achieve higher levels of nitrogen removal.” Please delete this sentence.

Response: This statement has been revised to indicate that the LTCP was prepared before the annual mass load limit for Blue Plains was established.

8. Page 4 – 11, Table 4-2 and Section 4.3.4 on page 4 – 12: WASA should provide supporting modeling or other documents which demonstrate that the CSOs will be reduced in both frequency and volume.

Response: This has been revised in the final TN/WW Plan.

9. Section 5.6 and 5.7 state: “Other changes as identified, to make the NPDES permit/LTCP consent consistent with the TN/WW Plan.” Please identify the changes and delete the broad, catch-all sentence. If additional inconsistencies appear, we will address them in good faith on a case-by-case basis.

Response: See response to comment no. 5.

- a. The following comments refer to the 450 mgd flow which was seen by EPA for the first time in the TN/WW Plan. The plan makes the incorrect assumption that 450 mgd is an agreed upon flow rate. If WASA wishes EPA to consider this flow rate it must provide supporting documents which demonstrate at a minimum the need for the flow, conditions under which it would be used and estimated numbers of times per year it would be in effect. Following are questions specifically relating to the peak flow issues:

- i. Page 1 – 8, 2 – 5 and 2 – 6. It is noted that Combined Sewer System Flow (CSSF) conditions are currently considered to exist at 511 mgd and above. WASA should provide information based on post-LTCP implementation, for a typical year;
- ii. The number of times per year that flow exceeds 555 mgd;

Responses to Comments

- iii. The number of times per year that flow is between 510 mgd and 555 mgd;
- iv. The number of times per year that flow is between 510 mgd and 555 mgd after the first 4 hours of storm event, and the total annual volume associated with those flows;
- v. The number of times per year that flow is between 450 mgd and 510 mgd.
- vi. The number of times per year that flow is between 450 mgd and 510 mgd after the first 28 hours of storm event, and the total annual volume associated with those flows.

Response:

The draft TN/WW plan proposed complete treatment rates for Outfall 002 of 555 mgd for the first four hours, 511 mgd for the next 24 hours, and 450 mgd thereafter. After the draft TN/WW plan was issued, WASA reviewed its projections for the frequency of long duration wet weather events and the capability of the plant to treat high flows. Based on this evaluation and in accordance with EPA's comment, the final TN/WW plan has revised the complete treatment rates for Outfall 002 to 555 mgd for the first four hours and 511 mgd thereafter.

- b. Section 2. WASA should provide a detail technical discussion for the impacts of extended operation at flows above 450 mgd, in order to justify the request for the lower CSSF value.

Response: See response to comment no. 9a.

- c. Section 4.1. The alternative evaluation appears to assume that the CSSF flow rate remains at 510 mgd, which is not consistent with WASA's request for 450 mgd after 28 hours. If this is the case, WASA should revise the analyses to reflect the flow through full treatment dropping to 450 mgd after 28 hours.

Response: See response to comment no. 9a. The analysis in the final TN/WW plan is based on complete treatment flow rates as follows: 555 mgd for the first four hours and 511 mgd thereafter.

- d. Appendix A, Figure 5. This figure raises an interesting question about WASA's request to drop the required sustained full treatment rate to 450 mgd. It is believed that this figure is intended to represent expected flows to the plant following LTCP implementation. WASA is asked to confirm that assumption. Assuming that this assumption is correct, it appears that during a substantial number of hours per year (perhaps 10% or about 875 hours per year), flow to the plant will be between 450 mgd and 475 mgd.

Response: See response to comment no. 9a.

- 10. Page S – 5. The plan does not make clear whether the Enhanced Clarification Facility (ECF) or the existing primary clarifiers will take the role of “lead” in handling peak flows. There may be advantages to the use of the ECF as dry weather primary treatment, in addition to its role during peak flow conditions.

Response: As indicated in the plan, the complete treatment train includes the primary clarifiers (not ECF). Complete treatment will be provided for up to 555 mgd for the first four hours, 511 mgd for the next 24 hours, and 450 mgd thereafter. At this time, ECF is not anticipated for use in dry weather. WASA may evaluate this as an operational strategy after the facility is constructed.

- 11. Page S – 5. Additional statistics on typical year dewatering operations should be provided. For example, how many gallons of tunnel dewatering flow should receive full treatment, versus how many gallons would receive full treatment via the ECF?

Response: In an average year, projections are that approximately 90% of flow from tunnel dewatering receives treatment by ECF, with the balance receiving complete treatment. Note that this results in lower pollutant loads discharged to the Potomac River and better water quality in the river than the LTCP. Further, the LTCP was determined by regulatory agencies to meet water quality standards, subject to post-construction monitoring.

Responses to Comments

12. Page S – 7. The TN/WW Plan notes that the years 1988 – 1990 were used to evaluate “typical year” performance. Did we understand correctly that another period may have been used to develop the annual TN limitation? If this understanding is correct, a comparison of the relevant statistics for the different year sets should be provided, and a discussion of the impacts of the differences between the various year sets should be provided.

Response: The annual TN limit in the permit was provided by EPA, and WASA has developed alternatives to meeting that limit. WASA used the rainfall in the years 1988-1990 to evaluate the various TN/WW plan alternatives and to demonstrate compliance with water quality standards, including achieving the TN limit.

13. Page S – 10. WASA should more accurately (i.e., less conservatively) characterize the performance expected for the Anacostia under Alternative D.

Response: See response to comment no. 8.

14. The following comments refer to the sizing of the Enhance Clarification Facility:

- a. Page S -11. The basis for the sizing of the proposed ECF and additional tunnel volume needs to be supported with more detailed technical and cost/performance information. WASA states that pilot testing of the CF technology will be carried out to “confirm its suitability...” What is WASA’s “fallback” option if the ECF were to be found unsuitable?

Response:

The storage capacity of Alternative D is based on providing tunnel capacity for the difference in the peak flow rates conveyed to Complete Treatment (740 mgd vs. 555 mgd) during the first four hours of a wet weather condition. The tunnel volume required is 740 mgd less 555 mgd which equals 185 mgd for four hours, or 31 million gallons (mg). With this additional storage volume provided, different rates of ECF treatment were evaluated to determine an ECF size that could produce an average year effluent quality equal to that produced by treating a peak rate of 1076 mgd (555 + 521 or 740 + 336) without adding additional storage. That ECF size was determined to be 225 mgd.

Based on recent facilities using the proposed ECF technologies, there is very low risk that ECF will be unsuitable. The pilot studies are, more importantly, to develop information for design.

- b. Section 4.3. WASA should provide cost/capacity and cost/performance information for incrementally larger sizes of both the ECF and the additional tunnel volume. This information will support a determination of the appropriate sizes for these proposed versions to the LTCP.

Response: See response to question 14a.

15. Page 2 – 12. In considering “firm” treatment capacities, the TN/WW Plan assumes one unit out of service in every treatment train. In general, “firm” capacity is based on the largest single unit out of service on a given treatment process. WASA’s assumption is unnecessarily conservative. Also, the TN/WW Plan notes primary performance drops to 10% total suspended solids (TSS) removal at high flow; it this with chemical feed in service?

Response: “Firm” capacity, based on the largest single unit out of service on a given treatment process, is often applied to pump stations and treatment trains with a handful or even a dozen units. In those cases, the percentage of the unit process out of service with one unit out of service ranges from 8 percent to 20 percent. In the case of the primary treatment process at Blue Plains, one unit out of service in the west process and one unit out of service in the east process is equivalent to 6 ¼ percent and 5 percent out of service, respectively. Therefore, the “firm” capacity assumption in the plan is not unnecessarily conservative. At very high flow rates, i.e., above 450 mgd, the hydraulic loading rate drives the performance independent of the chemical feed because the flow disturbs the

Responses to Comments

sludge withdrawal flow while the chemical feed enhances settling and does not improve sludge withdrawal.

16. Page S – 9. The TN/WW Plan infers that the Anacostia River will be the only part of the system (except for Blue Plains itself), in which the performance forecast by the LTCP will be materially changed by the April 2007 recommended alternative. WASA should confirm that this is correct.

Response: No change in performance for the Potomac and Rock Creek CSO controls is projected as a result of the TN/WW Plan.

17. Page 2 – 10. The East Process train appears to have the ability to give preference to flows from the separate sewer areas. Is that approach to processing wastewater entering the plan currently practiced? If not, has WASA evaluated the potential benefits of such a strategy?

Response: The collection system upstream of the east process train of the plant is combined and it is not possible to segregate combined and sanitary flows without substantial separation and other work in the collection system. Separation was evaluated as part of the development of the LTCP and it was determined to be prohibitively expensive, impractical, and to have worse environmental performance than the program ultimately adopted as the LTCP.

18. Page 2 – 11. What is the date that the East Primaries were rebuilt? The TN/WW Plan note that there are flow distribution issues associated with the East Side Primaries. Will these distribution issues be address in the TN/WW Plan?

Response: The east primary rehabilitation was completed in 2006. Flow distribution issues in the east primaries will be addressed as part of the TN/WW Plan.

19. Page 2 – 15. The TN/WW Plan notes that Nitrification/Denitrification waste activated sludge (WAS) is sent to the secondary treatment reactors to encourage nitrogen removal in the secondaries (it is noted that this practice is included in the BIOWIN modeling with positive results). It would seem likely that this practice may negatively impact secondary settling performance. Has WASA experimented with the amount of nitrification/denitrification WAS that is routed to secondary, to see if there is an optimal feed rate that maximizes total nitrogen removal, while minimizing undesirable secondary settling impacts?

Response: The amount of nitrification/denitrification waste activated sludge (WAS), all of which is routed to secondary, is variable. However, the settling characteristics in the secondary clarifiers do not correlate to the variability in the amount of nitrification/denitrification WAS routed to the secondary process.

20. Page 2 – 16. EPA notes that TN/WW Plan's recommendation to expand the size of Secondary Reactors 5 and 6 as part of the total nitrogen upgrade.

Response: Correct.

21. Section 2 – 3. When the Plan states that the capacity of individual units will be adequate, WASA should specify what plant and treatment flows this represents.

Response: This has been revised in the final TN/WW plan.

22. Page 2 – 36. As noted during a recent meeting with WASA, actual cold weather is not absolutely necessary to implement pilot testing; the influent can be refrigerated to stimulate cold weather effects.

Response: Pilot testing equipment will provide the ability to cool the influent to design temperatures.

23. Section 3.3.1. This section discusses various upgrades and changes that have been made to WASA's hydraulic models. It would be helpful to see a comparison of the performance of the original LTCP

Responses to Comments

predicted by both the “old” and “upgraded” models. Also, additional detail regarding each of the changes described in the bullets in the referenced section would also be helpful.

Response: Both the original and upgraded models make similar predictions regarding the degree of CSO performance provided by the original LTCP. Additional detail on the model upgrades has been included in the final plan.

24. Section 4.2. Given the expected performance of the ECF, are there any advantages to routing some of the ECF effluent directly to Enhanced Nitrogen Removal (ENR) as opposed to secondary treatment?

Response: The effluent from the ECF is expected to be low in solids and nitrogen but may contain soluble compounds that would best be removed in the secondary treatment process therefore; any advantages would not outweigh the risk of introducing biomass that may compete with the nitrifying biomass.

25. Page 5 – 2. There appears to be a typographical error in the fourth bullet on this page; the first “001” should be “002.” Also in that bullet is language that seems to imply that WASA need only meet its permit requirements, rather than maximize the use of whatever is constructed.

Response: In the fourth bullet from the top of the page, the first “001” has been changed to “002” in the Final TN/WW Plan.

Regarding language that “...seems to imply that WASA need only meet its permit requirements, rather than maximize the use of whatever is constructed”, we assume that refers to the following statement: “In accordance with the LTCP, CSOs on the Anacostia River will also be captured by the tunnel up to the diversion capacity specified in the NPDES Permit.” The facilities which divert CSO from the existing outfalls to the storage tunnel are designed for a maximum diversion rate. This rate was developed based on the modeling to achieve the degree of CSO reduction provided by the LTCP. The diversion rate is included in the NPDES permit. The statement in the TN/WW plan indicates that the diversion structures must be designed to convey some rate. If nature produces a storm which exceeds that design diversion rate, there will be remaining CSOs. This was identified in the LTCP and is specifically addressed in the NPDES Permit on page 41, Part III, C.3.3.

26. Appendix A to Appendix A. In the table titled, “Rainfall Probabilities at Washington Reagan National Airport,” it appears that the label under the abscissa should be “Percent of Time Less Than.”

Response: This has been revised in the final TN/WW Plan.

27. At a meeting to review the Draft TN/WW Plan on September 12, 2007, EPA provided an additional comment. WASA pointed out that the modified NPDES permit allocated the entire 4.689 million pounds of TN to Outfall 002. In addition, the fact sheet accompanying the permit appeared to have no nitrogen allocation for Outfall 001. EPA indicated that the intent was for the 4.689 million pound limit to apply to the sum of the discharges of Outfall 001 and 002.

Response: Please see Section 5.5 of the final plan.



**District of Columbia
Water and Sewer Authority**
Serving the Public • Protecting the Environment

www.dcwasa.com
